

# AUGUST PRODUCT & 2025 PRICE GUIDE

Hand Sinks

Scullery Sinks

Service/Mop Sinks

Work Tables

Equipment Stands

Dishtables

Cabinets

Shelving

Food Shields

Underbar

Aluminum Racks



Get the  
latest List Pricing at  
[advancetabco.com](http://advancetabco.com) or  
Autoquotes!

Follow Us:

@advancetabco



**ADVANCE TABCO**  
SMART FABRICATION™

[advancetabco.com](http://advancetabco.com)

800-645-3166

 [customer@advancetabco.com](mailto:customer@advancetabco.com)

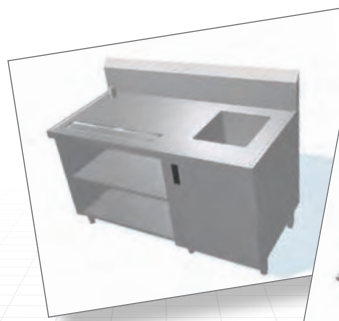

# Create Custom Fabricated Products in Real Time

*Serving Lines*

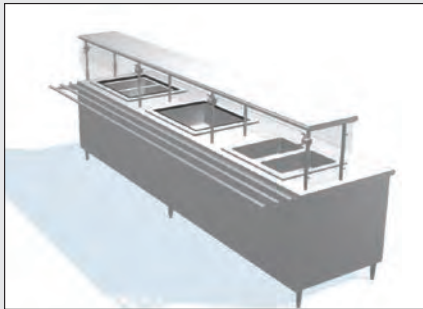

*Prep Stations*



*Beverage Tables*



- Generate written specs
- View your design in your space with Augmented Reality

- Accessories & modifications being added daily

## Now That's SMART FABRICATION™

### LOOK AT WHAT WE'RE DOING

#### CUSTOM FABRICATION

- Installation of Buyout Equipment
- Buyout Equipment Can Be Pre-Wired
- Load Centers Added
- Food Shields
- Laminate & Custom Vinyl Wraps Designed In-House



Concealed Load Centers for safety & easy access

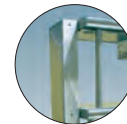

Custom Electrical Chases for buyout equipment



Wall Flashing in 16, 18 or 20 Ga. Stainless Steel & polished to a satin finish

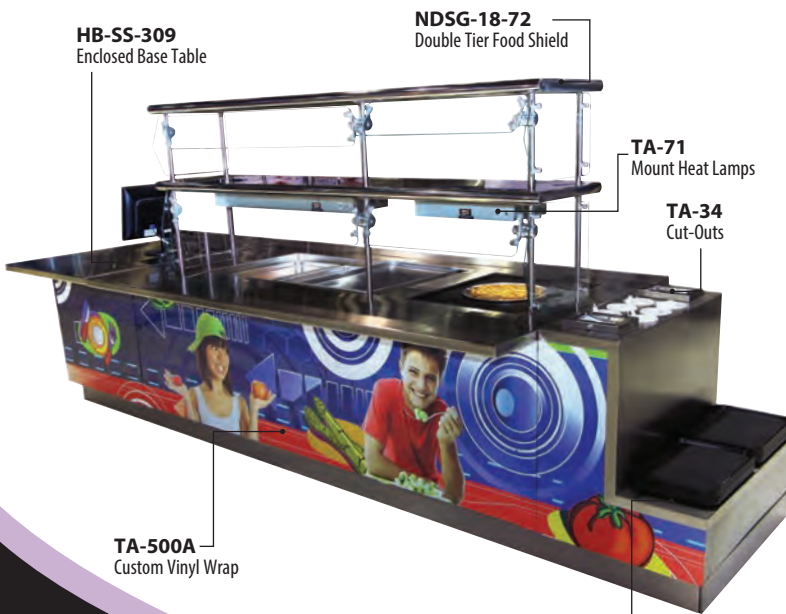

HB-SS-309 Enclosed Base Table

NDSG-18-72 Double Tier Food Shield

TA-71 Mount Heat Lamps

TA-34 Cut-Outs

TA-500A Custom Vinyl Wrap

TA-58 Step Down

## For Smart Fabrication™ Quotes

Email [Smartfab@advancetabco.com](mailto:Smartfab@advancetabco.com) or call our Estimating Department at 800-498-6634.

**CUSTOMER SERVICE IS AVAILABLE TO ASSIST YOU! (8:30AM - 7:00PM EST)**

# TABLE OF CONTENTS

## SINKS & SINK ACCESSORIES

Drop-In Sinks.....	3-5
Undermount Sinks.....	5
Hand Washing Sinks.....	6-11
Hand Sink Mods & Accessories .....	8, 11-14
Mobile Hand Sinks .....	53
Mop Sinks & Mop Sink Cabinets....	14-15, 17
Multi-Station: Wall Mounted .....	18-21
Multi-Station: Free-Standing .....	22-25
Faucets, Drains & P-Traps.....	4, 14, 38
NSF Regaline Sinks.....	26-31
NSF Fabricated Sinks .....	31-35
Sink Mods & Accessories .....	37-38
Specialty Sinks .....	11/31
Mobile & Silver Soak .....	36
Budget Skullery Sinks .....	36
Budget Skullery Sink Accessories.....	36
Floor Troughs, Floor Drains & Water Receptacles .....	39
Sink Cabinets .....	56
Integral Sinks.....	68

## TABLES & TABLE ACCESSORIES

Standard Work Tables.....	40-51
Enclosed Base Tables .....	52-54
Beverage Tables .....	55
Demo Tables.....	58
Tables with Sink .....	58
Corner Tables.....	58
Mixer Tables .....	59
Wall Mounted Tables.....	59
Equipment Stands.....	60
Filler Tables .....	63
Wood Top Tables.....	61-62
Poly Top Tables.....	63
Work Table Modifications & Accessories .....	64-68
Drawers & Accessories .....	69-71
Casters .....	71
Electrical Utility Chase.....	78

## FOOD SHIELDS

Food Shields for Multi-Use.....	72
Food Shields with S/S Shelf.....	72-74
Food Shields with Glass Top .....	72, 74, 75
Self Serve Food Shields (No Top).....	75
Stationary Food Shields .....	75
Portable Food Shields.....	75
Food Shield Accessories .....	76

LED Lighting.....	76
-------------------	----

## STAINLESS STEEL SHELVING

Table Undershelving .....	71
Table Mounted Shelving ..	74-76, 79, 80
Specialty Shelving .....	79, 81, 82
Wall Mounted Shelving.....	78, 80, 81
Tubular Drainage Shelving.....	33
Ceiling Mounted Shelving .....	82
Shelving Accessories .....	82
Sorting Shelves For Dishtables .....	94

## POT RACKS

Shelving with Pot Racks.....	81
Table Mounted .....	84
Leg Mounted .....	83
Ceiling Mounted .....	83
Wall Mounted .....	83

## DISHTABLES

Soil Dishtables.....	87, 88, 90
Clean Dishtables .....	90
3 Compartment Sink w/ Dishtable ....	91
Condensate Hoods .....	92
Vent Riser .....	92
Dishtable Modifications & Accessories .....	90, 91, 93, 94

## COUNTERTOPS

Stainless Steel Countertops.....	62
Integral Sinks.....	68

## CABINETS & WALL FLASHING

Stainless Steel Dish Cabinets .....	55
Sink Cabinets .....	56
Wall Cabinets .....	57
Storage Cabinets .....	57
Chemical Cabinets.....	57
Stainless Steel Wall Flashing .....	57

## Underbar Basics™

### UNDERBAR EQUIPMENT

#### Underbar Drop-Ins

Drop-In Water Stations.....	96
Drop-In Bar Hand Sinks .....	96-97
Drop-In Ice Bins .....	96-97
Drop-In Countertop Drain Pans .....	97

#### Bar Drink Rails

Drink Rails .....	97
-------------------	----

#### Free-Standing Bar Sinks

Bar Hand Sinks .....	96
Bar Hand Sinks with Built-In Soap & Towel Dispensers.....	98

Bar Hand Sink Modifications & Accessories .....	98, 122
Bar Sinks .....	98
Bar Sink/Ice Bin Combos.....	98

#### Glass Rinsers

Glass Rinser .....	97
--------------------	----

#### Ice Bins

Drop-In Ice Bins .....	96-97
Free-Standing Ice Bins.....	100
Ice Bin & Drainboard Combo.....	99
Portable Ice Bin .....	100
Ice Bin with Bottle Storage .....	99
Beer Boxes .....	103
Ice Bin Mods & Accessories .....	122

#### Bar Drainboards

Free Standing Bar Drainboards .....	104
Recessed Bar Drainboards.....	101
Frozen Drink Machine Stands.....	101
Drainboard Cabinets.....	104

#### Blender Stations

Blender Station with Dump Sinks.....	102
Blender Station Mods & Accessories .....	102, 122, 124

#### Uni-Serv Speed Bars

Complete Speed Bar Unit.....	102
------------------------------	-----

#### Bar Storage Units

Liquor Bottle Displays .....	103
Glass Rack Storage Cabinets.....	104
Drainboard Cabinets.....	104
With Dump Sink & Waste Chute .....	104
Storage Unit Accessories & Modifications .....	104, 122

#### Speed Rails

Stainless Steel Speed Rails .....	105
Black Plastic Speed Rails .....	105
Heavy Duty Speed Rails .....	105

#### Underbar Mods & Accessories

Underbar Mods & Accessories .....	122-124
Underbar Faucets .....	124

**PRESTIGE**  
*Signature Series*

### UNDERBAR EQUIPMENT

ON NEXT PAGE >>>

*Continued on Page 2*



**WARNING:** Equipment contained in this Price Guide may expose you to chemicals, including chromium & lead, that are known to the State of California to cause cancer or birth defects or other reproductive harm. For more Info., visit [www.p65warnings.ca.gov](http://www.p65warnings.ca.gov).



= PRODUCTS THROUGHOUT THE PRICE GUIDE WITH THIS ICON ARE SHIPPED VIA UPS

# TABLE OF CONTENTS



## UNDERBAR EQUIPMENT

### Prestige Modular Bar Die Systems

Exclusive Bar Die System ..... 106-107

### Prestige Free-Standing Bar Sinks

Bar Hand Sinks ..... 108-109

Bar Hand Sinks with Built-In

Soap & Towel Dispensers..... 108

Bar Hand Sinks with Cabinet Base ... 109

Bar Sink Modifications

& Accessories .....108, 122, 123, 125

Bar Sinks ..... 111

### Prestige Ice Bins

Free-Standing Ice Bins..... 112

Ice Bin & Bottle Storage..... 112

Beer Box..... 117

Pass-Thru Ice Bins ..... 117

### Prestige Uni-Serv Speed Bars

Complete Speed Bar Unit ..... 117

### Prestige Pass-Thru Work Stations

Standard Pass-Thru Workstations .... 118

Overshelves For Pass-Thru

Workstations..... 118

### Prestige Bar Drainboards

Drainboard Fillers..... 113

Free Standing Bar Drainboards ..... 114

Recessed Bar Drainboards..... 114

Frozen Drink Machine Stands..... 114

Drainboard With Blender Station..... 119

Drainboard Glass Rack Storage ..... 120

### Prestige Blender Stations

With Deep Drawn Sink ..... 119

With Drainboard .....119

Blender Shelf ..... 119

### Prestige Bar Storage Units

Point of Service Cabinet.....116

Drainboard Storage Cabinets .....116

Glass Rack Storage Cabinets..... 120

Liquor Bottle Displays ..... 120

### Trash Receptacles

Trash Receptacle Cabinets..... 116

### Prestige Speed Rails

Stainless Steel Speed Rails ..... 120

Hang-On Style Speed Rails ..... 120

### Under Bar Mods & Accessories

Soda Gun Holder for Prestige®

Pass-Thru Workstations ..... 123

Prestige Mods & Accessories... 122-124

### PORTABLE BARS

#### Heavy Duty Bars

Heavy Duty Bars ..... 125

With Stainless Steel Doors ..... 126

#### Standard Bars

Black Mica W/Stainless Steel Top .... 126

Black Mica W/All Stainless Steel

Work Area ..... 126

#### Portable Bar Options

Portable Bar with Laminates .....125

Portable Bar Mods & Accessories .....126

### HOT/COLD FOOD UNITS

#### Hot Well Drop-In Units

Standard Drop-In Units ..... 128

Slimline Drop-In Units..... 128

Hot Well Drop-In Accessories ..... 128

#### Hot Well Food Tables

Electric Powered Hot Food Tables ... 129

Electric Powered Sealed Well Tables 130

Gas Powered Hot Food Tables ..... 131

Gas Powered Wetbath Tables ..... 132

#### Solid Top Food Tables

Solid Top Food Tables..... 133

#### Cold Well Drop-In Units

Ice-Cooled Drop-In Cold Pan Units .. 134

Refrigerated Drop-In Cold Pan Units...134

#### Cold Food Tables

Standard Ice-Cooled Tables ..... 135

Mechanically Assisted

Cold Pans Tables ..... 136

#### Heavy Duty Food Tables

Electric Sealed Hot Well Tables ..... 137

Refrigerated Cold Well Tables ..... 137

Ice-Cooled Tables ..... 137

### Everyday Buffet Tables

Electric Hot Well Buffets ..... 138

Electric Sealed Hot Well Buffets..... 138

Ice Cooled Buffets..... 139

Solid Top Buffets ..... 139

Mechanically Assisted

Cold Pan Buffets ..... 140

Cash Register Stands ..... 140

Silverware Stand..... 140

Everyday Buffet Accessories ..... 141

### Food Table Shelving & Parts

Hot/Cold Food Table Shelving..... 141

Food Shields for Hot/cold Tables .....142

Hot Food Table Parts

& Accessories ..... 141-144

LED Lighting for Hot/Cold Tables .... 143

### ALUMINUM RACKS & PANS

Aluminum Racks ..... 145-149

Aluminum Bun Pans..... 150

Aluminum Rack Accessories ..... 146

### Mobile Racks & Carts

Aluminum Pan Trucks ..... 151

Aluminum Dunnage Racks ..... 151

Utility Carts ..... 151

### WIRE SHELVING

Chrome & Green Epoxy

Wire Shelving..... 152-153

Wire Utility Carts ..... 153

Wall Mounted Shelving System.....151

Wire Shelving Replacement Parts

& Accessories ..... 154

### WARRANTY

Warranty, Terms & Conditions ..... 155



**= PRODUCTS THROUGHOUT THE  
PRICE GUIDE WITH THIS ICON  
ARE SHIPPED VIA UPS**



# DROP-INS

## Drop-In Sinks

Holes Punched 4" O.C. For Faucet Hole Revision Order K-472 \$176 Cut-Out Size Requires 1-1/4" Radius Corners. Maximum Counter Thickness Is 2".

INCLUDES K-52 LEAD FREE COMPLIANT FAUCET & BASKET DRAIN. (DI-1-25 INCLUDES 2" DRAIN WITH STRAINER PLATE)

(To delete faucet, order K-52OMIT and deduct \$24)

All Sinks on this Page Ship Via UPS

### ONE COMPARTMENT Countertop Mounted, Self Rim Design

For Residential Finish & Packaging,  
Add K-350 \$528



#### DI-1-5 \$866

10" x 14" x 5" Bowl  
Overall: 13" x 19"  
Cut-out: 12 1/4" x 18 1/4"  
12 lbs. 2 cu. ft. 20 gauge



#### DI-1-10 \$982

10" x 14" x 10" Bowl  
Overall: 13" x 19"  
Cut-out: 12 1/4" x 18 1/4"  
14 lbs. 2 cu. ft. 20 gauge



#### DI-1-25 \$965

**Space Saver**  
9" x 9" x 5" Bowl  
Overall: 12" x 14"  
Cut-out: 11 1/4" x 13 1/4"  
8 lbs. 2 cu. ft. 20 gauge



#### DI-1-1515 \$1109

12 1/4" x 10 1/4" x 6" Bowl  
Overall: 15" x 15"  
Cut-out: 14 1/4" x 14 1/4"  
Requires 1 1/2" Radius Corners  
11 lbs. 2 cu. ft. 20 gauge



#### DI-1-35 \$1011

14" x 10" x 5" Bowl  
Overall: 17" x 15"  
Cut-out: 16 1/4" x 14 1/4"  
10 lbs. 2 cu. ft. 20 gauge



#### DI-1-168 \$1260

16" x 14" x 8" Bowl  
Overall: 19" x 19"  
Cut-out: 18 1/4" x 18 1/4"  
20 lbs. 3 cu. ft. 18 gauge



#### DI-1-208 \$1348

20" x 16" x 8" Bowl  
Overall: 23" x 21"  
Cut-out: 22 1/4" x 20 1/4"  
20 lbs. 3 cu. ft. 18 gauge



#### DI-1-2012 \$1548

20" x 16" x 12" Bowl  
Overall: 23" x 21"  
Cut-out: 22 1/4" x 20 1/4"  
20 lbs. 6 cu. ft. 18 gauge



#### DI-1-5SP \$2267

**6" Tapered Side Splash**

Splash on Rear and Both Sides  
10" x 14" x 5" Bowl  
Overall: 13" x 19"  
Cut-out: 12 1/4" x 18 1/4"  
16 lbs. 2 cu. ft. 20 gauge



#### DI-1-10SP \$2435

**6" Tapered Side Splash**

Splash on Rear and Both Sides  
10" x 14" x 10" Bowl  
Overall: 13" x 19"  
Cut-out: 12 1/4" x 18 1/4"  
18 lbs. 2 cu. ft. 20 gauge



#### DI-1-30 \$1478

**2" Tapered Side Splash**

14" x 10" x 5" Bowl  
Overall: 16" x 15"  
Cut-out: 15" x 14 1/4"  
12 lbs. 2 cu. ft. 20 gauge

Splash on  
All 3 Sides

Optional 12" Tapered Side Splash Upgrade K-12SS \$670

**IMPROVED!**  
Stronger Acuator



Includes  
water filler  
faucet,  
grating  
& drain

#### DI-1-9 \$1539

**Filler Station**  
9" x 9" x 3" Bowl  
Overall: 12" x 14"  
Cut-out: 11 1/4" x 13 1/4"  
15 lbs. 2 cu. ft. 20 gauge

### Removable 8" Splash Wrap for Existing Drop-In Sinks \$1190 ea.

Model #	Fits Drop-In Sink:
K-614A	DI-1-25 & DI-1-9
K-614B	DI-1-5 & DI-1-10
K-614C	DI-1-1515
K-614D	DI-1-30 & DI-1-35
K-614E	DI-1-168
K-614F	DI-1-208 & DI-1-2012
K-614G	DI-1-2812



Protect Your  
Surrounding Area!

### The Largest One Compartment Drop-In Sink in the Industry!

#### DI-1-2812 \$2638

28" x 20" x 12" Bowl  
Overall: 31" x 25"  
Cut-out: 30 1/4" x 24 1/4"  
47 lbs. 7 cu. ft. 16 gauge



Supplied with K-53 Lead Free Compliant Faucet & Basket Drain  
(To delete faucet, Order K-53OMIT and deduct \$24)

**WARNING:** Equipment that includes a faucet may expose you to chemicals, including lead, that are known to the State of California to cause cancer or birth defects or other reproductive harm. For more info, visit [www.p65warnings.ca.gov](http://www.p65warnings.ca.gov).

# DROP-INS

## Drop-In Sinks



= Ship Via UPS

Holes Punched 4" O.C. For Faucet Hole Revision Order K-472 \$176. Cut-Out Size Requires 1-1/4" Radius Corners.  
Maximum Counter Thickness Is 2".

INCLUDES K-50 LEAD FREE COMPLIANT FAUCET & BASKET DRAIN (To delete faucet, order K-500MIT and deduct \$24)

### TWO COMPARTMENT

Countertop Mounted, Self Rim Design



### THREE COMPARTMENT

Countertop Mounted, Self Rim Design

#### DI-3-10 \$2936

10" x 14" x 10" Bowl  
Overall: 38" x 19"  
Cut-out: 37 1/4" x 18 1/4"  
34 lbs. 5 cu. ft. 18 gauge



#### DI-2-10 \$1943

10" x 14" x 10" Bowl  
Overall: 25 1/2" x 19"  
Cut-out: 24 3/4" x 18 1/4"  
26 lbs. 4 cu. ft. 18 gauge

#### DI-2-2012 \$3056

20" x 16" x 12" Bowl  
Overall: 45 1/2" x 21"  
Cut-out: 44 3/4" x 20 1/4"  
42 lbs. 9 cu. ft. 18 gauge

#### DI-3-1410 \$3934

16" x 14" x 10" Bowl  
Overall: 50" x 21"  
Cut-out: 49 1/4" x 20 1/4"  
38 lbs. 8 cu. ft. 18 gauge



#### DI-2-1410 \$2920

14" x 16" x 10" Bowl  
Overall: 33 1/2" x 21"  
Cut-out: 32 3/4" x 20 1/4"  
35 lbs. 6 cu. ft. 18 gauge

#### DI-2-208 \$2389

20" x 16" x 8" Bowl  
Overall: 45 1/2" x 21"  
Cut-out: 44 3/4" x 20 1/4"  
40 lbs. 6 cu. ft. 18 gauge

#### DI-3-1612 \$4432

16" x 20" x 12" Bowl  
Overall: 56" x 25"  
Cut-out: 55 1/4" x 24 1/4"  
60 lbs. 12 cu. ft. 18 gauge



Includes a K-53 Faucet. To delete, order K-530MIT & deduct \$24

**DID YOU KNOW?** 2 & 3 Compartment Drop-In Sinks are N.S.F. Approved when only used in Mobile Food Carts and Kiosks.

# FAUCETS & SPOUTS

## Deck Mounted Faucets, Spouts & Mounting Clips

#### Drinking Bubbler

K-47 \$1110



#### 8" Swing Spout

K-50 \$396



#### Water Filler Faucet

K-54

8-1/4" High \$781

K-54A

12" High \$887



#### Swing Spout Faucet & Spray

K-58 \$466

8" O.C.



#### Mounting Clips Extended



For Countertops Over 7/8" & up to 2" Thick  
Quantity supplied (4-Pack), varies based on drop-in sink ordered.

K-28 \$22

#### Deck Mounted Single Handle Faucet

K-48 \$777



#### 3-1/2" Gooseneck

K-52 \$348



Wrist Handles for Deck Mt. Faucets  
K-316-LU \$167



#### Large 8-1/2" Spout Gooseneck

K-55

\$657

4" O.C.



#### EXTRA HEAVY DUTY Gooseneck

K-62 \$676

4" O.C.

Upgrade



#### 12" Swing Spout

K-53 \$657

4" O.C.



#### Deck Mounted Faucet with Wrist Handles

K-56

\$497

4" O.C.



#### 6" Deck Mounted Extended Faucet with Wrist Handles

K-208

\$686

4" O.C.



#### FAUCET REPAIR KITS\*

For K-50, K-52, K-53, K-55, K-56

K-00B \$176

(2 Cartridges & 2 Handles Per Set)

\*Can Only Be Used On Faucets Purchased After January 2016. For Older Faucets, Consult Customer Service.

For K-54 & K-54A Filler Faucet

K-02 \$147

Purchased from 2016 to 2019



K-02A \$147

Purchased before 2016 or after 2019



**WARNING:** Equipment that includes a faucet may expose you to chemicals, including lead, that are known to the State of California to cause cancer or birth defects or other reproductive harm. For more info, visit [www.p65warnings.ca.gov](http://www.p65warnings.ca.gov).

# SMART SERIES™

Countertop Mounted, Self Rim Design

# DROP-INS

## Drop-In Sinks

Maximum Counter Thickness is 2". 8" O.C. Faucet Holes: Unit punched with 1-1/4" Diameter for the hot & cold water supply lines. Center hole punched with 1" Diameter.  
For Faucet Revision Order K-472 \$185.

- 18 Gauge, Seamless Deep Drawn Self Rimming Stainless Steel Bowls.
- Bowls Are Sound Deadened.
- Flat Deck Allowing More Faucet Options.
- Units Feature Advance Tabco's Smart Finish.
- Faucet Optional

### SINGLE BOWL DROP-IN SINKS

Model #	Price	O.A. Size L x W	Bowl Size L x W	Cut-Out Size (1 1/4" Radius Corners)	Wt.	Cu. Ft.
SS-1-1319-10	\$1603	13" x 19"	14" x 10" x 10"	12 1/4" x 18 1/4"	14 lbs.	2
SS-1-1715-7	1603	17" x 15"	14" x 10" x 7 1/2"	16 1/4" x 14 1/4"	12 lbs.	2
SS-1-1715-10	1787	17" x 15"	14" x 10" x 10"	16 1/4" x 14 1/4"	14 lbs.	3
SS-1-1919-7	1905	19" x 19"	16" x 14" x 7 1/2"	18 1/4" x 18 1/4"	16 lbs.	3
SS-1-1919-10	2011	19" x 19"	16" x 14" x 10"	18 1/4" x 18 1/4"	18 lbs.	4
SS-1-1919-12	2093	19" x 19"	16" x 14" x 12"	18 1/4" x 18 1/4"	20 lbs.	4
SS-1-2321-10	2263	23" x 21"	20" x 16" x 10"	22 1/4" x 20 1/4"	22 lbs.	6
SS-1-2321-12	2406	23" x 21"	20" x 16" x 12"	22 1/4" x 20 1/4"	24 lbs.	6

### DOUBLE BOWL DROP-IN SINKS

SS-2-3321-10	2588	33 1/2" x 21"	14" x 16" x 10"	32 3/4" x 20 1/4"	35 lbs.	6
SS-2-3321-12	2822	33 1/2" x 21"	14" x 16" x 12"	32 3/4" x 20 1/4"	37 lbs.	9
SS-2-4521-10*	3038	45 1/2" x 21"	20" x 16" x 10"	44 3/4" x 20 1/4"	39 lbs.	9
SS-2-4521-12*	3319	45 1/2" x 21"	20" x 16" x 12"	44 3/4" x 20 1/4"	40 lbs.	10

SS-1-1715-7  
Shown



SS-1-2321-10  
Shown



SS-2-3321-10  
Shown



### STAINLESS STEEL SINK GRIDS

- Perforated Grid
- Raised Bottom
- Side Notches for Easy Removal

K-610 \$1119

(Specify Bowl Size When Ordering)

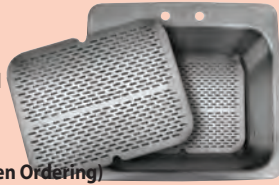

### 8" O.C. DECK MOUNT FAUCETS

5-1/2" Spout  
K-132  
\$1048



9" Spout  
K-133  
\$1023



# UNDERMOUNTS

Undermount Bowls are suitable to be welded by others into stainless steel products. Multiple compartment assemblies available. Call for pricing.

- 3 1/2" Drain Opening
- 1-1/4" Outside Flange



2028A-12 Shown



CO-1014A-10RE Shown

Model #	Price	# Of Compartments	Gauge	Bowl Size LxWxD	Radius	O.D. Trim Size
1014B-05	\$581	1	20	10" x 14" x 5"	2"	12 1/2" x 16 1/2"
1014A-10	706	1	20	10" x 14" x 10"	2"	12 1/2" x 16 1/2"
1014A-10A	910	1	18	10" x 14" x 10"	2"	12 1/2" x 16 1/2"
CO-1014A-10RE*	1283	1	18	10" x 14" x 10"	2"	12 1/2" x 16 1/2"
1014-210-BAD	1569	2	18	10" x 14" x 10"	2"	25" x 16 1/2"
1014-310-BAD	2462	3	18	10" x 14" x 10"	2"	37 1/2" x 16 1/2"
CO-1416A-10RE*	1361	1	18	14" x 16" x 10"	3"	12 1/2" x 18 1/2"
1416-212-BAD	2609	2	18	14" x 16" x 12"	3"	33" x 18 1/2"
1416-312-BAD	4007	3	18	14" x 16" x 12"	3"	49 1/2" x 18 1/2"
1620A-10	1130	1	18	16" x 20" x 10"	3"	18 1/2" x 22 1/2"
1620A-12	1343	1	18	16" x 20" x 12"	3"	18 1/2" x 22 1/2"
1620A-14A	1663	1	14	16" x 20" x 14"	3"	18 1/2" x 22 1/2"
1620-212-BAD	2876	2	16	16" x 20" x 12"	3"	37" x 22 1/2"
1620-312-BAD	4408	3	16	16" x 20" x 12"	3"	55 1/2" x 22 1/2"
2020A-12	1504	1	18	20" x 20" x 12"	3"	22 1/2" x 22 1/2"
2020A-14	1623	1	18	20" x 20" x 14"	3"	22 1/2" x 22 1/2"
2028A-12	2492	1	16	20" x 28" x 12"	3"	22 1/2" x 30 1/2"
2028A-14A	2798	1	14	20" x 28" x 14"	3"	22 1/2" x 30 1/2"
2424A-14A	2932	1	14	24" x 24" x 14"	3"	26 1/2" x 26 1/2"

\* Includes Residential Finish & Packaging. Add K-350 \$528 for Other Models to Add Residential Finish & Packaging.

**WARNING:** Equipment that includes a faucet may expose you to chemicals, including lead, that are known to the State of California to cause cancer or birth defects or other reproductive harm. For more info., visit [www.p65warnings.ca.gov](http://www.p65warnings.ca.gov).

# HAND SINKS

## Hand Washing Sinks



To delete faucet, order K-590MIT and deduct \$24

= All Sinks On This Page Ship Via UPS



All Sinks on this Page

### STANDARD UNITS

Bowl Size: 10" x 14" x 5" • Overall Size: 15 1/4" x 17 1/4" Unless Otherwise Specified  
Includes K-59 Splash Mount Faucet, 3-1/2" Basket Drain & Wall Bracket (Unless Otherwise Specified)



**7-PS-60 \$881**  
Standard Unit  
13 lbs. 2 cu. ft. 20 gauge



**7-PS-68 \$1048**  
K-316 Splash Mount  
Wrist Handle Faucet  
13 lbs. 2 cu. ft. 20 gauge



**7-PS-67 \$974**  
Lever Operated  
15 lbs. 2 cu. ft. 20 gauge



**7-PS-20 \$919**  
K-22 Deck Mount Faucet  
15 lbs. 3 cu. ft. 20 gauge  
Overall Size: 17-1/4" x 17-1/4"



**7-PS-50 \$1152**  
Lever Operated Drain  
with Overflow & P-Trap  
15 lbs. 2 cu. ft. 20 gauge



**7-PS-54 \$1065**  
1-1/2" P-Trap  
15 lbs. 2 cu. ft. 20 gauge



**7-PS-57 \$1549**  
K-159 8" O.C. Splash  
Mounted Faucet  
1-1/2" P-Trap with Tailpiece  
Side Support Brackets  
Strainer Plate  
25 lbs. 2 cu. ft. 20 gauge

### SIDE SPLASH UNITS

Bowl Size: 10" x 14" x 5" • Overall Size: 15 1/4" x 17 1/4" Unless Otherwise Specified  
Includes 7-3/4" High Welded Side Splashes, K-59 Splash Mount Faucet, 3-1/2" Basket Drain & Wall Bracket (Unless Otherwise Specified)



**7-PS-66R or L \$1390**  
Right or Left Side Splash  
13 lbs. 2 cu. ft. 20 gauge

Unit Shown:  
7-PS-66R



**7-PS-66 \$1499**  
Standard Unit  
19 lbs. 2 cu. ft. 20 gauge



**7-PS-66W \$1613**  
K-316 Splash Mt. Faucet  
w/ Wrist Handles  
19 lbs. 2 cu. ft. 20 gauge



**7-PS-40 \$1831**  
Lever Operated  
With Overflow & P-Trap  
20 lbs. 2 cu. ft. 20 gauge



**7-PS-76 \$2339**  
Full Length Removable  
Utility Tray  
K-59 Splash Mt. Faucet  
Lever Operated  
With Overflow & P-Trap  
12" High Welded Side Splashes  
24 lbs. 2 cu. ft. 20 gauge



**7-PS-87 \$3025**  
Towel & Soap Dispenser  
K-316 Splash Mt. Faucet  
with Wrist Handles  
Lever Operated  
With Overflow & P-Trap  
34 lbs. 10 cu. ft. 20 gauge



**7-PS-73 \$2938**  
7 3/4" High Side Splashes  
Towel Dispenser  
Deck Mt. Soap Dispenser  
K-123 Splash Mt. Faucet  
31 lbs. 5 cu. ft. 20 gauge

**DID YOU KNOW?**

You Can Add Side Splashes To Any Hand Sink  
See Page 12

**WARNING:** Equipment that includes a faucet may expose you to chemicals, including lead, that are known to the State of California to cause cancer or birth defects or other reproductive harm. For more info, visit [www.p65warnings.ca.gov](http://www.p65warnings.ca.gov).



All Sinks on this Page



All Sinks On This Page Ship Via UPS

# HAND SINKS

## Hand Washing Sinks

### SOAP & TOWEL DISPENSER UNITS

Bowl Size: 10" x 14" x 5" • Overall Size: 15 1/4" x 17 1/4"

Includes C-Fold Style Towel Dispenser, Liquid Soap Dispenser, K-59 Splash Mount Faucet, 3-1/2" Basket Drain & Wall Bracket (Unless Otherwise Specified)  
To delete faucet, order K-590MIT and deduct \$24



**7-PS-69 \$3254**  
Splash Mounted Faucet  
With Wrist Handles  
Lever Operated With  
Overflow & P-Trap  
Side Support Brackets  
K-69 (T&S) Faucet  
35 lbs. 6 cu. ft. 20 gauge



**7-PS-79 \$2199**  
Standard Unit  
32 lbs. 10 cu. ft. 20 gauge



**7-PS-80 \$2411**  
Lever Operated  
With Overflow & P-Trap  
32 lbs. 10 cu. ft. 20 gauge

ALL-IN-ONE  
UNIT



**7-PS-85 \$2682**  
P-Trap & Skirt  
35 lbs. 6 cu. ft. 20 gauge



**7-PS-131 \$5452**  
All-In-One  
Touchless Soap Dispenser  
Towel Dispenser  
7-3/4" High Side Splashes  
K-175 Faucet  
40 lbs. 10 cu. ft. 20 gauge

#### UPGRADE TO TOUCHLESS SOAP DISPENSER

Battery Powered (4 "AA" Batteries Required, Not Included)  
Add **7-PS-104 \$463** Plus **7-PS-120MIT** (Deduct -\$49)  
Excludes 7-PS-131



### UNDERMOUNT TOWEL DISPENSER UNITS

#### 7-PS-41 \$6510

A.D.A. Compliant Tapered Bowl Design  
Hands Free Operated Faucet  
Undermount Towel Dispenser  
1-1/2" Drain w/ Flat-Top Strainer Plate  
16 Gauge Skirt with Enclosed Bottom  
For Storage w/ Removable Access Panel  
43 lbs. 8 cu. ft. 18 gauge



Available with K-123 "D" Spout  
Splash Mt. Wrist Handle Faucet  
**7-PS-46 \$4320**

For More A.D.A. Compliant  
Sinks, please see page 10.



#### 7-PS-65 \$2562

Undermount Towel Dispenser  
with Skirt  
Deck Mounted Soap Dispenser  
K-22 Deck Mounted Faucet  
35 lbs. 10 cu. ft. 20 gauge

### 12" WIDE SPACE SAVER UNITS

Bowl Size: 9" x 9" x 5" • Overall Size: 16" x 12"  
Includes 2" Drain With Flat Top Strainer & Wall Bracket



**7-PS-22 \$1135**  
K-22 Deck Mounted Faucet  
12 lbs. 2 cu. ft. 20 gauge



**7-PS-23 \$1187**  
K-123 Splash Mounted Faucet  
12 lbs. 2 cu. ft. 20 gauge



**7-PS-53 \$3379**  
K-175 Splash Mt. Electronic Faucet  
12 lbs. 2 cu. ft. 20 gauge



**7-PS-56 \$1815**  
K-123 Splash Mounted Faucet  
8" High Side Splashes  
14 lbs. 2 cu. ft. 20 gauge



**7-PS-88 \$2382**  
Undermount Towel Dispenser  
Deck Mt. Soap Dispenser  
K-22 Deck Mt. Faucet  
23 lbs. 10 cu. ft. 20 gauge

### SOAP/TOWEL UNITS



7-PS-83

#### 7-PS-83 \$2228

Towel Dispenser  
Deck Mt. Soap Dispenser  
K-22 Deck Mt. Faucet  
27 lbs. 5 cu. ft. 20 gauge



7-PS-89

#### 7-PS-89 \$4241

7 3/4" High Side Splashes  
Towel Dispenser  
Deck Mt. Soap Dispenser  
K-175 Splash Mt. Electronic Faucet  
40 lbs. 5 cu. ft. 20 gauge



7-PS-84

#### 7-PS-84 \$2322

Towel Dispenser  
Deck Mt. Soap Dispenser  
K-123 Splash Mt. Faucet  
27 lbs. 5 cu. ft. 20 gauge



7-PS-73

#### 7-PS-73 \$2938

7 3/4" High Side Splashes  
Towel Dispenser  
Deck Mt. Soap Dispenser  
K-123 Splash Mt. Faucet  
31 lbs. 5 cu. ft. 20 gauge

# HANDS-FREE Hand Washing Sinks



All Sinks on this Page



All Sinks On This Page Ship Via UPS

## HANDS-FREE ELECTRONIC OPERATED FAUCETS

Bowl Size: 10" x 14" x 5" • Overall Size: 15 1/4" x 17 1/4" Includes K-175 AC/DC Powered Electronic Operated Faucet

**7-PS-131**  
**\$5452**

**All-In-One**  
Touchless Soap Dispenser  
Towel Dispenser  
7-3/4" High Side Splashes  
K-175 Faucet  
40 lbs. 10 cu. ft. 20 gauge



7-PS-81 Shown

**7-PS-51 \$3341**

Equal to 7-PS-50 w/ K-175 Faucet  
21 lbs. 2 cu. ft. 20 gauge

**7-PS-81 \$4600**

Equal to 7-PS-80 w/ K-175 Faucet  
32 lbs. 10 cu. ft. 20 gauge

**7-PS-52 \$4384**

Equal to 7-PS-81. Excludes Lever Drain, P-Trap and Overflow  
31 lbs. 10 cu. ft. 20 gauge

Upgrade To Touchless Soap Dispenser,  
Add 7-PS-104 **\$463**  
Plus 7-PS-120MIT (Deduct **-\$49**)



**7-PS-61 \$3073**

Equal to 7-PS-60 w/ K-175 Faucet  
19 lbs. 2 cu. ft. 20 gauge



**7-PS-91 \$4439**

Equal to 7-PS-90 w/ K-175 Faucet  
41 lbs. 10 cu. ft. 20 gauge

## KNEE VALVE OPERATED FAUCETS

Includes Single Knee Valve (With Built-In Mixing Valve), K-121 Splash Mt. Gooseneck Spout, Skirt, 3-1/2" Basket Drain (Otherwise Noted) & Wall Bracket



**7-PS-62 \$2244**

**Standard Unit**  
Bowl Size: 10" x 14" x 5"  
Overall : 15-1/4" x 17-1/4"  
25 lbs. 2 cu. ft. 20 gauge



**7-PS-30 \$2416**

**Large Bowl Size**  
Bowl Size: 16" (F/B) x 14" x 6"  
Overall : 21-1/4" (F/B) x 17-1/4"  
33 lbs. 8 cu. ft. 18 gauge



**7-PS-59 \$2901**

**Side Splash Unit**  
Bowl Size: 10" x 14" x 5"  
Overall : 15-1/4" x 17-1/4"  
7-3/4" Side Splashes  
31 lbs. 2 cu. ft. 20 gauge



**7-PS-63 \$2244**

**Spacesaver**  
1-1/2" Basket Drain  
Bowl Size: 9" x 9" x 5"  
Overall : 12-1/4" x 16"  
20 lbs. 8 cu. ft. 18 gauge



**7-PS-58 \$2898**

**Spacesaver With Side Splashes**  
7-3/4" Side Splashes  
1-1/2" Basket Drain  
Bowl Size: 9" x 9" x 5"  
Overall : 12-1/4" x 16"  
26 lbs. 8 cu. ft. 18 gauge



**7-PS-78 \$2799**

**Large Bowl Size**  
Bowl Size: 16" x 20" x 8"  
Overall : 24-7/8" x 22"  
40 lbs. 8 cu. ft. 18 gauge



**7-PS-82 \$3073**

**Towel & Soap Dispenser**  
Bowl Size: 10" x 14" x 5"  
Overall : 15-1/4" x 17-1/4"  
38 lbs. 6 cu. ft. 20 gauge

Upgrade To Touchless Soap Dispenser,  
Add 7-PS-104 **\$463**  
Plus 7-PS-120MIT (Deduct **-\$49**)

### You Can Put A Skirt On Any Handsink

(Excludes sinks with existing bases or skirts. Sinks Not Included)

**7-PS-31**  
**\$783**

Fits Hand Sinks with 10" x 14" Bowl and Splash Mounted Faucets

**7-PS-31A**  
**\$847**

Fits Hand Sinks with 9" x 9" Bowl Only

**7-PS-31B**  
**\$880**

Fits Hand Sinks with 10" x 14" Bowl and Deck Mounted Faucets



## KNEE & PEDAL VALVE REPLACEMENT PARTS & FAUCETS

### Foot Pedal Valve Replacement

Combo. H/C  
Single Pedal  
**K-103 \$702**

Foot Pedal with Retaining Pin Only  
**K-17 \$175**



### Knee Valve Replacement

Combo. H/C  
Single Pedal  
**K-104 \$882**

Knee Pedal with Retaining Pin Only  
**K-18 \$175**



### Foot Pedal Assembly w/Floor Bracket

**7-PS-39**  
**\$943**



### Knee Valve Assembly w/ Mounting Bracket

**7-PS-32**  
**\$1125**



### Splash Mounted Gooseneck Spout

**K-121**  
**\$207**

### Replacement Check Valves

**K-19**  
**\$35 set of 2**



### Mixing Valve & Retainer

**K-19A**  
**\$29**



### Thermostatic Mixing Valve

**K-425**  
**\$570**



### Replacement Bonnet for Pedal/Knee Valve

(K-103 & K-104, 7-PS-32 & 7-PS-39)

**K-1**  
**\$76**





All Sinks on this Page



All Sinks On This Page Ship Via UPS

# HANDS-FREE Hand Washing Sinks

## FOOT PEDAL VALVE UNITS

Includes Single Pedal Valve (With Built-In Mixing Valve), K-121 Splash Mt. Gooseneck Spout, 3-1/2" Basket Drain & Wall Bracket, Removable Panel for Plumbing Access



### 7-PS-90 \$2313

**Standard Unit**

Bowl Size:  
10" x 14" x 5"  
Overall :  
17-1/4" x 15-1/4" x 42"  
41 lbs. 10 cu. ft. 20 gauge



### 7-PS-96 \$2942

**Side Splash Unit**

7-3/4" High Side Splashes  
Bowl Size:  
10" x 14" x 5"  
Overall :  
17-1/4" x 15-1/4" x 42"  
41 lbs. 10 cu. ft. 20 gauge



### 7-PS-18 \$2779

**Large Bowl Size**

Bowl Size:  
16" (F/B) x 14" x 6"  
Overall :  
21-1/4" (F/B) x 17-1/4" x 42"  
50 lbs. 11 cu. ft. 18 gauge



### 7-PS-86 \$2890

**Extra Large Bowl Size**

Bowl Size:  
16" x 20" x 8"  
Overall :  
24-7/8" (F/B) x 22" x 41-1/2"  
55 lbs. 16 cu. ft. 20 gauge



Upgrade To Touchless Soap Dispenser,  
Add 7-PS-104 \$463  
Plus 7-PS-120MIT (Deduct -\$49)

### 7-PS-99 \$4183

**Towel & Soap Dispenser  
Trash Receptacle**

Bowl Size:  
10" (F/B)x 14" x 5"  
Overall :  
17-1/4" (F/B) x 15-1/4" x 42"  
59 lbs. 15 cu. ft. 20 gauge



### 7-PS-95 \$3361

**Towel & Soap Dispenser**

Bowl Size:  
10" (F/B) x 14" x 5"  
Overall :  
17-1/4" (F/B) x 15-1/4" x 42"  
54 lbs. 15 cu. ft. 20 gauge



## You Can Put a Pedestal Base On Any Hand Sink

(Excludes Sinks With Existing Bases Or Skirts. Sinks Not Included)



### Basic Pedestal Base

7-PS-37 \$878

For 10" x 14" Bowls

7-PS-37B \$1099

For 10" x 14" bowls and  
Deck Mounted Faucets

7-PS-37C \$1176

For 16" x 20" Bowls



### With Foot Valve

7-PS-33 \$1222

For 10" x 14" Bowls

7-PS-33B \$1542

For 10" x 14" Bowls and  
Deck Mounted Faucets

7-PS-33C \$1664

For 16" x 20" Bowls



### Add Trash Receptacle

7-PS-29 \$995

Use above model number with  
any Pedestal Base Sink or  
Stand-Alone Pedestal Base.



Plastic Replacement  
Handles 7-PS-38 \$61

## FAUCETS OMITTED

Bowl Size: 10" x 14" x 5". Overall Size: 15 1/4" x 17 1/4"



### 7-PS-70 \$804

Equal To 7-PS-60 Without Faucet



### 7-PS-71 \$884

Equal To 7-PS-70 With  
Single Hole Punch



### 7-PS-20-NF \$877

Equal To 7-PS-20 Without Faucet



### 7-PS-66-NF \$1455

Equal To 7-PS-66 Without Faucet

**WARNING:** Equipment that includes a faucet may expose you to chemicals, including lead, that are known to the State of California to cause cancer or birth defects or other reproductive harm. For more info., visit [www.p65warnings.ca.gov](http://www.p65warnings.ca.gov).

# HAND SINKS

## Hand Washing Sinks

All Sinks On This Page  
Ship Via UPS

**NSF** All Sinks on this Page

**DID YOU KNOW?**

You Can Add a K-175 or K-180 Electronic Faucet To Any Hand Sink \$2318  
(May require faucet hole revision. See Page 14.)



### A.D.A. UNITS FOR THE PHYSICALLY CHALLENGED

Bowl Size: 16" x 14" x 5". Overall Size: 20" x 24" • Includes 1-1/2" Drain With Strainer Plate & Wall Bracket



**7-PS-25 \$2141**

K-208 Deck Mounted Faucet with Wrist Handles  
Deck Mounted Soap Dispenser  
Wall Support Brackets  
25 lbs. 8 cu. ft. 18 gauge



**7-PS-75 \$1846**

Same As 7-PS-25 With 8" O.C. Faucet Holes Only (Faucet Not Included)



**7-PS-751 \$1846**

Same As 7-PS-75 With Single Hole (Faucet Not Included)



**7-PS-26 \$4573**

Same As 7-PS-25 With K-180 Hands Free AC/DC Operated Faucet  
Deck Mounted Soap Dispenser

**7-PS-77-E \$6227**

**Tapered Bowl Design**

Hands Free Operated Faucet  
Deck Mount Soap Dispenser  
16 Gauge Skirt with Enclosed Bottom w/ Removable Access Panel  
65 lbs. 8 cu. ft. 18 gauge



**7-PS-77-W \$4038**

Same As Above with 4" O.C. Wrist Handle Faucet

**7-PS-41 \$6510**

**Tapered Bowl Design w/ Undermount Towel Dispenser**

Hands Free Operated Faucet  
Deck Mount Soap Dispenser  
16 Gauge Skirt with Enclosed Bottom w/ Removable Access Panel  
65 lbs. 8 cu. ft. 18 gauge



**7-PS-46 \$4320**

Same As Above with 4" O.C. Wrist Handle Faucet

### LARGE SIZE SINK BOWLS

Includes K-59 Splash Mt. Gooseneck Faucet, 3-1/2" Basket Drain, Wall Bracket w/ 2 Support Brackets

**7-PS-45 \$1528**

Bowl Size: 16" x 20" x 8"  
Overall Size: 24 3/4" x 21 7/8"  
31 lbs. 8 cu. ft. 18 gauge



**7-PS-49 \$1428**

Bowl Size: 14" x 16" x 8"  
Overall Size: 19-1/4" x 19"  
30 lbs. 8 cu. ft. 18 gauge

### SECURITY UNITS

Bowl Size: 10" x 14" x 5" • Require Minimum Security Installations  
Includes Heavy Duty Gooseneck Faucet, Concealed 3 1/2" Drain & Wall Bracket

**7-PS-747 \$4545**

Class 2 Upgrade  
45 lbs. 10 cu. ft. 20 gauge



**7-PS-727 \$5775**

Class 1 Upgrade  
Towel Dispenser  
Provisions For Installation Of Soap Dispenser (By Others)  
65 lbs. 15 cu. ft. 20 gauge



### COUNTERTOP INSTALLED HAND SINKS

- 4" High Side Splashes
- K-52 Deck Mounted Faucet
- Deck Mounted Soap Dispenser
- Built-In Towel Dispenser
- 3-1/2" Basket Drain



**7-PS-42 \$4103**

Bowl Size: 10" x 14" x 5"  
Overall Size: 18-1/4" x 17-5/8"  
30 lbs. 2 cu. ft. 20 gauge



**7-PS-42A \$4103**

Bowl Size: 9" x 9" x 5"  
Overall Size: 17-3/8" x 13"  
26 lbs. 2 cu. ft. 20 gauge

- 4" High Side Splashes
- Deck Mounted Gooseneck Spout
- Knee Operated Valve
- Deck Mounted Soap Dispenser
- Built-In Towel Dispenser
- 3-1/2" Basket Drain

**7-PS-43 \$4750**

Bowl Size: 10" x 14" x 5"  
Overall Size: 18-1/4" x 17-5/8"  
36 lbs. 2 cu. ft. 20 gauge



For Factory Installation, Add TA-503 \$644. Can Be Purchased Separately For In-Field Installation



All Sinks on this Page

All Items On This Page Ship Via UPS

# HAND SINKS

## Hand Washing Sinks

### SPECIALTY SINKS

Bowl Size: 10" x 14" x 5" • Overall Size: 15 1/4" x 17 1/4" (Excludes 7-PS-72 & 7-PS-44)  
Includes 3-1/2" Basket Drain & Wall Bracket



**7-PS-55 \$1602**

**EYE WASH STATION**  
Gooseneck Faucet  
w/ Eye Wash Attachment  
15 lbs. 3 cu. ft. 20 gauge



**7-PS-72 \$1636**

**METERED FAUCET**  
H.A.C.C.P. Compliant  
Slow Self-Closing Metering  
Faucet with Mixing Valve  
15 lbs. 3 cu. ft. 20 gauge



**7-PS-64 \$1428**

**EXTRA SUPPORT**  
Splash Mounted  
Gooseneck Faucet  
Tubular Support Brackets  
25 lbs. 2 cu. ft. 20 gauge



**7-PS-44 \$3752**

**BODY ACTIVATED VALVE**  
K-121 Splash Mounted  
Gooseneck Spout  
28 lbs. 2 cu. ft. 18 gauge

### CONCEALED HAND SINK DRAWER

Take Back Your Countertop Space!

- Easily Installs into Existing Advance Tabco Work Tables/Countertops or Integrates into Custom Fabrication
- Overall Size: 22 5/8" W x 19 7/8" L x 19 1/4" H"
- 10" x 14" x 5" Deep Sink Bowl
- Pre-Drilled Holes In Flanges For Easy Mounting
- Integral Drawer Slides For Smooth Operation
- "Safety Stop" Tab
- K-50 Swing Spout Faucet
- 1-1/2" Sink Drain with Strainer Plate
- Drainage Pan with 1-1/2" Drain & Strainer Plate (Drain Pipe & Fittings Included.)



**7-PS-47 \$4004**

70 lbs. 7 cu. ft.  
18 gauge exterior  
16 gauge interior



### HAND SINK WITH UTILITY SINK

**7-PS-COMBO \$8138**

- 16 gauge stainless steel.
  - Removable right side access panel. Left side panel with faucets on left side also available (Specify when ordering).
  - Bolt-on stainless steel legs adjustable & bullet feet.
  - Hot/cold swing spout faucet with Laminar Flow Device.
  - Pot filler faucet with single handle on/off handle & hook. Includes continuous water hold down ring & 68" stainless steel hose.
  - Concealed 3-1/2" Drain
  - Wall Bracket
- 83 lbs. 15 cu. ft. 16 gauge

Hand Sink Bowl Size: 10" x 14" x 5"

Utility Bowl: 6 1/8" x 16 1/8" x 6"



Side Access Panel

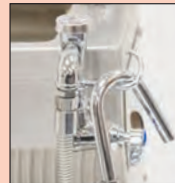

Pot Filler Faucet

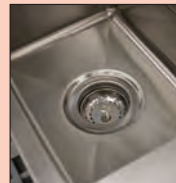

10" x 14" x 5" Hand Sink



6 1/8" x 16 1/8" x 6" Utility Bowl W/Removable Grates

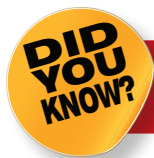

You Can Add Side Splashes To Any Hand Sink

See Page 12

# MODS & ACCESSORIES

## Hand Sink Modifications & Accessories

### WELDED SIDE SPLASHES FOR HAND SINKS

Factory Installed Only



7-3/4" Side Splash Shown



Two 7-3/4" Welded Side Splashes Shown



Shown with Optional Utility Tray

Two 24" Welded Side Splashes & Back Panel Shown



Two 12" Welded Side Splashes Shown

#### Removable Utility Tray For Side Splashes

- 8" X 3" X 2 5/16" Tray.
- Tray Hem Allows To Hang From Any Standard Side Splash.
- Perforated For Water Drainage.

7-PS-48 \$454



7-3/4" HEIGHT SPLASH				12" HEIGHT SPLASH				24" HEIGHT SPLASH				Description
1 Side Splash		2 Side Splashes		1 Side Splash		2 Side Splashes		2 Side Splashes & Rear Panel*				
Model #	Price	Model #	Price	Model #	Price	Model #	Price	Model #	Price	Model #	Price	
7-PS-16	\$547	7-PS-17	\$696	7-PS-11	\$666	7-PS-15	\$749	7-PS-28	\$1694			Units w/ 10" x 14" Bowl & Splash Mount Faucet
7-PS-16A	547	7-PS-17A	712	7-PS-11A	666	7-PS-15A	749	7-PS-28A	1694			Units w/ 9" x 9" Bowls
7-PS-16B	581	7-PS-17B	765	7-PS-11B	716	7-PS-15B	799	7-PS-28B	1710			Units w/ 10" x 14" Bowl & Deck Mount Faucet
7-PS-16C	595	7-PS-17C	798	7-PS-11C	749	7-PS-15C	830	7-PS-28C	1809			Units w/ 16" x 20" Bowls
7-PS-16D	646	7-PS-17D	834	7-PS-11D	810	7-PS-15D	923	7-PS-28D	1847			For Handicapped Hand Sinks
7-PS-16E	589	7-PS-17E	780	7-PS-11E	796	7-PS-15E	904	7-PS-28E	1764			Units w/ 14" (F/B) x 16" Bowls
7-PS-16F	589	7-PS-17F	780	7-PS-11F	796	7-PS-15F	904	7-PS-28F	1780			Units w/ 16" (F/B) x 14" Bowls

\*24" high splashes include a rear panel that matches the height of the side splashes. Only available as 2 side design. Single side not offered. Includes rear mounting holes.

## BOLT-ON SINGLE PANEL SPLASH FOR HAND SINKS

### 7-3/4" & 12" Height Bolt-On Splash

(Priced Per Splash. Order 2 for Both Sides)

Includes Holes. Hardware not Included.

All Bolt-On Splashes Ship Via UPS



7-PS-25 Shown With Optional Side Splashes.

7-3/4" HEIGHT SPLASH			12" HEIGHT SPLASH			Description
Model #	Price Ea.		Model #	Price Ea.		
7-PS-27	\$158		7-PS-13	\$285		Units w/ 10" x 14" Bowl & Splash Mount Faucet
7-PS-27A	158		7-PS-13A	343		Units w/ 9" x 9" Bowls
7-PS-27B	158		7-PS-13B	380		Units w/ 10" x 14" Bowl & Deck Mount Faucet
7-PS-27C	266		7-PS-13C	396		Units w/ 16" x 20" Bowls
7-PS-27D	301		7-PS-13D	366		For Handicapped Hand Sinks
7-PS-27E	337		7-PS-13E	364		Units w/ 14" (F/B) x 16" Bowls
7-PS-27F	337		7-PS-13F	364		Units w/ 16" (F/B) x 14" Bowls

## Instant Hot Water ON DEMAND

This unit allows for hand sinks to be installed in remote areas with just a cold water supply and available 30 amp electric power. There is no delay or wasted water while waiting for hot water to reach the faucet. Includes Heater & Plumbing Hardware.

7-PS-92 \$3104

HANDSINK NOT INCLUDED



1 Single Supply Line Of Cold Water Is Required To Feed The Unit!

## Side Mounting Wall Brackets

Includes 2 brackets. Used for Added Strength & Support (Add to price of sink)

7-PS-36 \$195

## Tubular Wall Supports

Set of 2 Supports

Model #	Price	Description
7-PS-24	\$657	Units w/ 10"x14" Bowl & Splash Mt. Faucet
7-PS-24B	657	Units w/ 10"x14" Bowl & Deck Mt. Faucet
7-PS-24C	770	Units with 16"x14" & 16"x20" Bowls



# MODS & ACCESSORIES

## Hand Sink Modifications & Accessories

 All items On This Page Ship Via UPS

### SOAP/TOWEL DISPENSERS & MIRRORS



**C-Fold Style Paper Towel & Soap Dispenser**  
Mounts On 17" Wide Hand Sinks Only.  
**7-PS-34 \$1593**

Upgrade To Touchless Soap Dispenser, Add 7-PS-104 \$463  
Plus 7-PS-120MIT (Deduct -\$49)



**Wall Mounted Liquid Soap Dispenser**  
Mounting Hardware Included.  
**7-PS-12 \$266**



**Wall Mounted Touchless Liquid Soap Dispenser**  
Battery Powered (4 "AA" Batteries Required, Not Included).  
Mounting Hardware Included.  
Low Soap Indicator Window.  
Low Battery Indicator Light.  
**7-PS-104 \$463**



**Wall Mounted Paper Towel Dispenser**  
Holds C-Fold Style Towels.  
**7-PS-35 \$487**



**Deck Mounted Liquid Soap Dispenser**  
**K-12 \$222**



**Wall Mounted Stainless Steel Liquid Soap Dispenser**  
Mounting Hardware Included.  
**K-13 \$604**

See Below For Mounting on Hand Sinks



**Back Splash with K-13 Soap Dispenser**  
Mounts On Hand Sinks With 10" X 14" Sink Bowls Only.  
(Hardware not included)  
**7-PS-34B \$1716**



### DRAINS, PARTS & P-TRAPS



1-1/2" IPS

**3-1/2" Basket Drain Assembly**  
**K-6 \$67**



1-1/2" IPS

**2" Drain Assembly w/ Strainer Plate**  
**K-63 \$57**



**Drain Basket For K-6**  
**K-310 \$42**

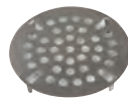

**Replacement Strainer Plates**  
for 3-1/2" Drain for 2" Drain  
**K-410 \$36 K-411 \$34**



1-1/2" IPS

**Standard Chrome Plated P-Traps**  
22 Gauge  
**7-PS-14 \$174**  
17 Gauge  
**7-PS-10 \$196**



**Replacement Washers for 3-1/2" Drains**  
**K-67F \$21 (Set of 2)**

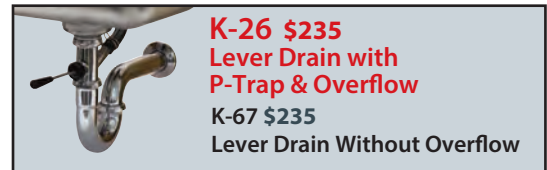

**K-26 \$235**  
**Lever Drain with P-Trap & Overflow**  
**K-67 \$235**  
**Lever Drain Without Overflow**

#### REPLACEMENT PARTS FOR K-26 DRAIN



Model #	Description	Price
K-67A	Tail Piece with Overflow Branch Only	\$41
K-67B	Overflow Hose with 2 Spring Clips	25
K-67C	Plastic 90° Overflow Head & Body	21
K-67D	Lever Handle for K-26 Drain	22
K-67E	Plastic Stopper (Includes "O" Ring)	21

# HAND SINK FAUCETS

## Hand Washing Sinks

### HAND SINK FAUCETS & SPOUTS



**Extra Heavy Duty  
Splash Mounted Faucet  
K-69 \$684**  
4" O.C.  
Wrist Handles For K-69  
K-416-TS-LU \$517 set



**3-1/2" Splash  
Mounted Faucet  
K-59 \$348**  
4" O.C.



**3-1/2" Splash  
Mounted Faucet  
with Wrist Handles  
K-316 \$521**  
4" O.C.



**Deck Mounted  
Faucet  
K-22 \$319**  
4" O.C.

Wrist Handles  
For Faucets  
(Excludes K-69)  
K-316-LU \$175 set



#### SINGLE HOLE FAUCETS

Deck Mount  
8" Swing Spout  
K-64 \$740



**3-1/2" Gooseneck Spouts  
(No Handles)**



Deck Mount  
K-120 \$315



Splash Mounted  
K-121 \$207

#### ELECTRONIC HANDS FREE FAUCETS



Powered  
by AC or  
Battery!

Splash Mt.  
K-175  
\$2318

Deck Mt.  
K-180  
\$2318



Replacement  
Control Module  
K-09  
\$1048

#### "D" SPOUT EXTENDED FAUCETS



Deck Mt. 6"  
Extended Spout  
K-124 \$503  
4" O.C.



Deck Mt. w/  
Wrist Handles  
K-208 \$686  
4" O.C.



Splash Mt. 6"  
Extended Spout  
K-123 \$518  
4" O.C.



Splash Mt. w/  
Wrist Handles  
K-206 \$655  
4" O.C.

#### SPECIALTY FAUCETS & SPOUTS



Slow-Released  
Metered Faucet  
K-190 \$844



Eye-Wash  
Attachment  
K-170 \$691



Hands-Free Wand  
Spout Not Included  
K-400 \$142 ea.

#### Pot Filler Faucet

- Single Hole
- Side/Splash Mounted
- 3-1/2" Hook Nozzle
- Finger Hook
- 68" Flexible Stainless Steel Hose

K-65 \$1727



#### REPLACEMENT CARTRIDGES WITH HANDLES\*

(Set of 2. Includes Cartridges and Handles)

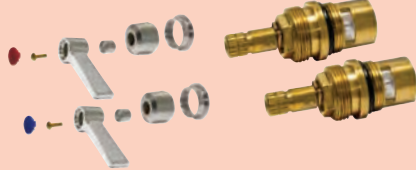

For Faucets: K-59, K-123, K-125, K-126, K-206 & K-316  
K-00A \$176

For Faucets: K-1, K-11, K-50, K-51, K-52, K-53, K-56,  
K-124, K-101, K-159, K-160, K-208 & K-240

K-00B \$176

\*Can Only Be Used On Faucets Purchased After January 2016.  
For Older Faucets, Consult Customer Service.



Low Flow  
Aerator .5 GPM  
K-08 \$53

#### REPLACEMENT FAUCET SPOUTS

Model #	Spout Size/Style	For Faucet Model	Price
K-52SP	3-1/2" Swivel Gooseneck	K-52	<b>\$82</b>
K-55SP	8-1/2" Swivel Gooseneck	K-55	<b>130</b>
K-59SP	3-1/2" Swivel Gooseneck	K-59	<b>82</b>
K-208SP	6" Extended Swivel Gooseneck	K-208	<b>93</b>
K-175SP	4-1/2" Swivel Gooseneck	K-175/K-180	<b>194</b>
K-50SP	8" Swing Spout	K-50	<b>90</b>
K-53SP	12" Swing Spout	K-53	<b>122</b>

#### Faucet Hole Modifications

K-70	Punch for 8" O.C. Faucet Holes	<b>\$185</b>
K-70A	Punch for Single Hole Splash Mt. Faucet	<b>\$185</b>
K-71	Punch for Single Hole Deck Mt. Faucet	<b>\$185</b>

Faucet Not Included

# MOP SINKS

## Mop Sink Cabinets

### 84" HIGH STAINLESS STEEL MOP SINK CABINETS

 = Ships Via UPS



#### Single Width

- Single Left-Hinged Door\*
- 1 Fixed Stainless Steel Mid-Shelf
- Ventilation Slots
- 2 Mop Holders
- Open Back For Plumbing
- 16 Ga., Type 304 S/S Mop Sink & Drain
- Door pre-punched and capped for optional SU-27 Door Lock

16" x 20" x 12" Bowl  
Overall Size: 22-5/8" x 25" x 84"



#### Double Width

- Hinged Double Doors
- Opening For Mop Bucket To Roll In
- 4 Fixed Stainless Steel Mid-Shelves (3 In Storage Side, 1 Above Sink)
- Enclosed Back Panel
- Ventilation Slots
- 2 Mop Holders
- Open Back For Plumbing
- 16 Ga., Type 304 S/S Mop Sink & Drain
- Door pre-punched and capped for optional SU-27 Door Lock

16" x 20" x 12" Bowl  
Overall Size: 22-5/8" x 50-1/4" x 84"

9-OPC-84DR Shown

Model #	Cabinet Material	Price	Approx. Wt.	Approx. Cu.
9-OPC-84	18 Ga., 430 S/S	\$10586	238 lbs.	40
9-OPC-84-300	18 Ga., 300 S/S	12298	238 lbs.	40

\*Optional Right-Hand Door Swing Available - Add CAB-R N/C

**Convert Mop Sink In Cabinet To Drop Front. Add K-281 \$1006**

Model #	Cabinet Material	Price	Approx. Wt.	Approx. Cu.
9-OPC-84DR	18 Ga., 430 S/S	\$14409	390 lbs.	72
9-OPC-84DL	18 Ga., 430 S/S	15129	390 lbs.	72
9-OPC-84DR-300	18 Ga., 300 S/S	15862	390 lbs.	72
9-OPC-84DL-300	18 Ga., 300 S/S	15862	390 lbs.	72

R And L Indicates Mop Sink Location.

#### Stainless Steel Cabinet with Floor



Sink Not Included

- Overall Size: 22-5/8" x 25" x 84"
- Single Left-Hinged Door\*
- Fixed Stainless Steel Mid-Shelves
- Enclosed Back Panel
- Ventilation Slots On Both Sides

Model #	# of Fixed Shelves	Price	Approx. Wt.	Approx. Cu.
18 Ga. CAB-1	1	\$7729	200 lbs.	40
430 S/S CAB-4	4	8960	240 lbs.	40
18 Ga. CAB-1-300	1	8433	200 lbs.	40
300 S/S CAB-4-300	4	9836	240 lbs.	40

\*Optional Right-Hand Door Swing Available - Add CAB-R N/C



#### CHEMICAL STORAGE CABINET

w/ 1 Fixed Stainless Steel Mid-Shelf

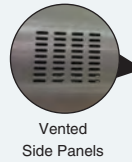

Vented Side Panels



WCH-15-24 Left Hinged Shown (Standard)

- Left-Hinged Door\*
- Vented Side Panels
- Wall Mounting Hardware Not Included

**WCH-15-24 \$6501**

18 Gauge, 430 Stainless Steel

**WCH-15-24-300 \$7203**

18 Gauge, 300 Stainless Steel

\*Optional Right-Hand Door Swing Available - Add CAB-R N/C

Overall Size: 15" x 24" x 32-1/2"

### MOP SINK CABINET ACCESSORIES & MODIFICATIONS



Service Faucet For Mop Sinks  
8" O.C.

K-240\* \$1046 

\*K-240 Does Not Meet Federal Lead Free Standards As It Is Not Intended For Potable Water.



Service Faucet Vacuum Breaker Repair Kit  
K-03 \$187 



Mop Sink Replacement Drain  
K-16 \$260 



Double Cabinet Doors

Convert Single Width Cabinet to Double Doors

K-84-CAB \$1036

Add Rear Panel To Cabinet

K-94-BACK \$712  
K-94-BACK-300 \$1032

Add K-472 for 8" O.C. Faucet Holes  
\$150 Per Hole



Additional Fixed Mid-Shelf  
K-94-SHELF \$547 ea.  
For 84" High Cabinets

WC-SHELF \$131 lin. ft.  
For Wall Cabinets

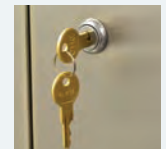

Cabinet Door Lock With Keys  
SU-27 \$474

Required For Each Hinged Door

S-Hook Mop Hanger  
K-91 \$44 ea.



 **WARNING:** Faucets on this page may expose you to chemicals, including lead, that are known to the State of California to cause cancer or birth defects or other reproductive harm. For more info, visit [www.p65warnings.ca.gov](http://www.p65warnings.ca.gov).

# MOP SINKS

## Mop Sinks

### FLOOR MOP SINKS Mounting Hardware Included

- Floor mounted unit eliminates the need of lifting heavy containers.
- Tile edge furnished on the rear.
- Notched out front which allows for ease of emptying mop bucket.
- K-16 3-1/2" Free Flow Drain. Connects to a 2" drain pipe.
- Stainless Steel Strainer Basket with Handle

Model #	Bowl Size	Overall Dimension	Price	Approx. Wt.	Approx. Cu.
<b>STANDARD MOP SINKS</b>					
9-OP-18	15" x 15" x 10"	18" x 18"	<b>\$1055</b>	30 lbs.	4
9-OP-20	16" x 20" x 6"	21" x 25"	<b>\$1365</b>	33 lbs.	4
9-OP-28	20" x 28" x 6"	25" x 33"	<b>2200</b>	47 lbs.	7
9-OP-40	16" x 20" x 12"	21" x 25"	<b>2073</b>	45 lbs.	6
9-OP-48	20" x 28" x 12"	25" x 33"	<b>2310</b>	62 lbs.	9
<b>LARGE MOP SINK BOWL</b>					
9-OP-44	24" x 24" x 12"	29" x 29"	<b>1949</b>	70 lbs.	9
9-OP-33	24" x 36" x 12"	29" x 41"	<b>5750</b>	80 lbs.	9
9-OP-34	24" x 48" x 12"	29" x 53"	<b>6895</b>	90 lbs.	9
<b>DROP-FRONT MOP SINKS</b>					
9-OP-40DF	16" x 20" x 12"	18 1/2" x 25"	<b>4023</b>	85 lbs.	9
9-OP-48DF	20" x 28" x 12"	22 1/2" x 33"	<b>4476</b>	110 lbs.	15

= Ships Via UPS

NSF

**CUSTOM SIZES AVAILABLE**

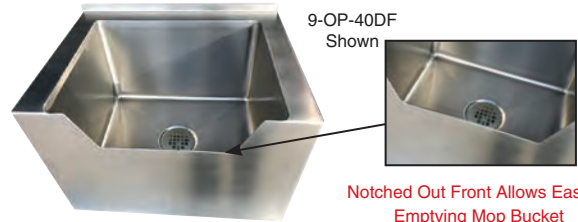

Convert Mop Sink In Cabinet To Drop Front. Add K-281 \$1239 (Not Offered On 9-Op-40 Or 9-Op-48 Or 6" Deep Mop Sinks)

## CORNER DROP-FRONT FLOOR MOP SINK

Mounting Hardware Included

- Floor mounted unit eliminates the need of lifting heavy containers.
- Tile edge furnished on the rear.
- Notched out front which allows for ease of emptying mop bucket.
- K-16 3-1/2" Free Flow Drain. Connects to a 2" drain pipe.
- Stainless Steel Strainer Basket with Handle

**SPACE SAVER!**

Model #	Bowl Size	Overall Dimension	Price	Approx. Wt.	Approx. Cu.
9-OP-44CDF	23 7/8" x 23 7/8" x 12"	26 1/2" x 26 1/2"	<b>\$2415</b>	110 lbs.	15



## FLUSH-MOUNT FLOOR MOP SINK

- Easy Mop Bucket Roll-In Design
- Standard Backsplash with Left & Right Splash, Left Splash or Right Splash Available
- 4" O.D. - 3" Long Plumbing Sleeve
- Front Anti-Splash Guard
- Removable Subway Grating
- Stainless Steel Strainer Basket with Handle



WITH STAINLESS STEEL GRATES			WITH FIBERGLASS GRATES			Bowl Size	Overall	Splashes	Cu.
Model #	Wt.	Price	Model #	Wt.	Price				
9-OP-24FM-SSRL	128 lbs.	<b>\$6469</b>	9-OP-24FM-FGRL	96 lbs.	<b>\$6469</b>	21 3/8" x 22 x 10"	21 3/8" x 24"	Back, Left & Right	14
9-OP-24FM-SSL	120 lbs.	<b>6249</b>	9-OP-24FM-FGL	88 lbs.	<b>6249</b>	21 3/8" x 22 x 10"	21 3/8" x 24"	Back & Left	14
9-OP-24FM-SSR	120 lbs.	<b>6249</b>	9-OP-24FM-FGR	88 lbs.	<b>6249</b>	21 3/8" x 22 x 10"	21 3/8" x 24"	Back & Right	14
9-OP-36FM-SSRL	158 lbs.	<b>\$7760</b>	9-OP-36FM-FGRL	126 lbs.	<b>\$7760</b>	34" x 22 x 10"	36" x 24"	Back, Left & Right	14
9-OP-36FM-SSL	150 lbs.	<b>7500</b>	9-OP-36FM-FGL	118 lbs.	<b>7500</b>	34" x 22 x 10"	36" x 24"	Back & Left	14
9-OP-36FM-SSR	150 lbs.	<b>7500</b>	9-OP-36FM-FGR	118 lbs.	<b>7500</b>	34" x 22 x 10"	36" x 24"	Back & Right	14

## HAND SINK WITH UTILITY SINK

### 7-PS-COMBO \$8138

- 16 gauge stainless steel.
- Removable right side access panel. Left side panel with faucets on left side also available (Specify when ordering).
- Bolt-on stainless steel legs adjustable & bullet feet & Wall Bracket.
- Hot/cold swing spout faucet with Laminar Flow Device.
- Pot filler faucet with single handle on/off handle & hook. Includes continuous water hold down ring & 68" stainless steel hose.
- Concealed 3-1/2" Drain

Hand Sink Bowl Size: 10" x 14" x 5"  
Utility Bowl: 6 1/8" x 16 1/8" x 6"

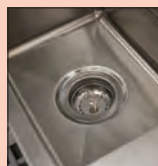
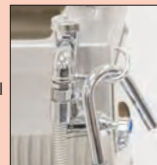

 = Ships Via UPS



Fabricated Sink Bowl



Deep Drawn Sink Bowl

## STANDING SERVICE SINKS





Heavy Gauge Stainless Steel • 8" Bowl Depth • 8" High Backsplash • Stainless Steel Legs with Adjustable Bullet Feet  
 • 8-OP-16 Includes Stainless Steel Cross-Bracing • 8" O.C. Faucet Holes • 3-1/2" Basket Drain

Model #	Bowl Size	Overall Dimension	Price	Approx. Wt.	Approx. Cu.
8-OP-16	16" x 20" x 8"	25" x 23"	<b>\$2347</b>	50 lbs.	13 
4-OP-18	24" x 21" x 8"	24" x 25"	<b>1602</b>	50 lbs.	10





## MOP SINK ACCESSORIES & MODIFICATIONS

### 16" HIGH SIDE & BACK SPLASHES FOR FLOOR MOP SINKS 16 Gauge, 300 Series Stainless Steel

#### Splashes on All 3 Sides

Model #	Fits Units:	Model #	Fits Units:	Price
K-298	9-OP-20 9-OP-40	K-298D	9-OP-40DF	<b>\$1002</b> 
K-299	9-OP-28 9-OP-48	K-299D	9-OP-48DF	<b>1077</b> 
K-300	9-OP-44	-	-	<b>1271</b> 
K-303	9-OP-33	-	-	<b>1348</b> 
K-304	9-OP-34	-	-	<b>1446</b> 

#### Splash on Left or Right & Back

Model #	Fits Units:	Model #	Fits Units:	Price
K-288LorR	9-OP-20 9-OP-40	K-288LorRD	9-OP-40DF	<b>\$770</b> 
K-290LorR	9-OP-28 9-OP-48	K-290LorRD	9-OP-48DF	<b>840</b> 
K-291LorR	9-OP44	-	-	<b>909</b> 
K-293LorR	9-OP33	-	-	<b>956</b> 
K-294LorR	9-OP-34	-	-	<b>1024</b> 



Left & Right Splashes Shown

Height Above Finished Floor (A.F.F.)

9-OP-20/9-OP-28 = 26" High 9-OP-40/9-OP-40DF/9-OP-44/9-OP-48/ 9-OP-48DF = 32" High

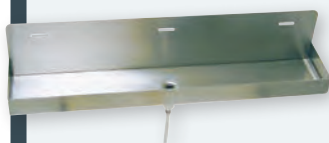

#### Wall Mounted Drainage Tray K-243 \$777

- Used with Floor Mounted Mop Sinks
- 16 Gauge, 300 Series Stainless Steel
- Includes 1/2" Drain & Plastic Hose
- 2" Tray Ht. with 6" Rear Splash (O.A.)
- 20" x 4" x 6". 13 lbs.



#### Hose & Hanger K-244 \$310



#### 23" Mop Hanger K-242 \$337



#### Service Faucet For Mop Sinks 8" O.C.

K-240\* **\$1014** 

\*K-240 Does Not Meet Federal Lead Free Standards As It Is Not Intended For Potable Water.



#### Service Faucet Vacuum Breaker Repair Kit K-03 \$187



#### Mop Sink Replacement Drain K-16 \$260

# MULTI-STATIONS

## NSF Multi-Stations



= Ships Via UPS

### 14 GAUGE, 304 STAINLESS STEEL SINKS WITH TUBULAR SUPPORTS OR LEGS

8" Bowl Depth • 8 1/2" High Backsplash • 8" O.C. Faucet Holes on Manual Operated, Single Holes on Knee or Electronic Operated • 3 1/2" Basket Drain(s).

"-F" Series Splash Mount Models Include K-159 3-1/2" Goosenecks. "-F" Series Deck Mount Models Include K-134 8-1/2" Goosenecks.



L	W	Bowl Size W x L x D	NO FAUCETS INCLUDED		MANUAL FAUCETS INCLUDED		ELECTRONIC OPERATED FAUCETS		KNEE OPERATED FAUCETS		# of Faucets
			Splash Mount	Price	Splash Mount	Price	Splash Mount	Price	Splash Mount	Price	
40"	19.5"	16" x 37" x 8"	FS-WM-40	\$5999	FS-WM-40-F	\$6725	FS-WM-40EF	\$9416	FS-WM-40KV	\$7856	2
48"	19.5"	16" x 45" x 8"	FS-WM-48	6336	FS-WM-48-F	7062	FS-WM-48EF	9553	FS-WM-48KV	8193	2
60"	19.5"	16" x 57" x 8"	FS-WM-60	6673	FS-WM-60-F	7762	FS-WM-60EF	11789	FS-WM-60KV	9449	3
72"	19.5"	16" x 69" x 8"	FS-WM-72	7038	FS-WM-72-F	8127	FS-WM-72EF	12154	FS-WM-72KV	9814	3
80"	19.5"	16" x 77" x 8"	FS-WM-80	7565	FS-WM-80-F	9016	FS-WM-80EF	14386	FS-WM-80KV	11266	4
96"	19.5"	16" x 93" x 8"	FS-WM-96	7902	FS-WM-96-F	9553	FS-WM-96EF	14723	FS-WM-96KV	11631	4
100"	19.5"	16" x 97" x 8"	FS-WM-100	8295	FS-WM-100-F	10112	FS-WM-100EF	16825	FS-WM-100KV	12925	5
120"	19.5"	16" x 117" x 8"	FS-WM-120	10460	FS-WM-120-F	12638	FS-WM-120EF	20694	FS-WM-120KV	16014	6



### 14 GAUGE, 304 STAINLESS STEEL A.D.A. SINKS WITH TUBULAR SUPPORTS

5" Bowl Depth • 8 1/2" High Backsplash • 8" O.C. Faucet Holes on Manual Operated or Single Holes on Electronic Faucet Operated • Rear 3 1/2" Basket Drain(s).

"-F" Series Splash Mount Models Include K-161-LU 6" Goosenecks. "-F" Series Deck Mount Models Include K-134 8-1/2" Goosenecks.

L	W	Bowl Size W x L x D	NO FAUCETS INCLUDED		MANUAL FAUCETS INCLUDED		ELECTRONIC OPERATED FAUCETS		# of Faucets
			Splash Mount	Price	Splash Mount	Price	Splash Mount	Price	
40"	19.5"	16" x 37" x 5"	FS-WM-40-ADA	\$5949	FS-WM-40-ADA-F	\$6675	FS-WM-40EFADA	\$9366	2
48"	19.5"	16" x 45" x 5"	FS-WM-48-ADA	6286	FS-WM-48-ADA-F	7012	FS-WM-48EFADA	9503	2
60"	19.5"	16" x 57" x 5"	FS-WM-60-ADA	6623	FS-WM-60-ADA-F	8127	FS-WM-60EFADA	11739	3
72"	19.5"	16" x 69" x 5"	FS-WM-72-ADA	6988	FS-WM-72-ADA-F	8966	FS-WM-72EFADA	12104	3
80"	19.5"	16" x 77" x 5"	FS-WM-80-ADA	7515	FS-WM-80-ADA-F	8966	FS-WM-80EFADA	14336	4
96"	19.5"	16" x 93" x 5"	FS-WM-96-ADA	7852	FS-WM-96-ADA-F	9503	FS-WM-96EFADA	14673	4
100"	19.5"	16" x 97" x 5"	FS-WM-100-ADA	8245	FS-WM-100-ADA-F	10062	FS-WM-100EFADA	16775	5
120"	19.5"	16" x 117" x 5"	FS-WM-120-ADA	10410	FS-WM-120-ADA-F	12588	FS-WM-120EFADA	20644	6



FS-WM-60EFADA Shown

†Add K-472 For  
Faucet Hole Revision **\$185**

### 16 GAUGE, 304 STAINLESS STEEL SINKS WITH TUBULAR SUPPORTS OR LEGS

8" Bowl Depth • 8 1/2" High Backsplash • 8" O.C. Faucet Holes on Manual Operated, Single Holes on Knee or Electronic Operated • 3 1/2" Basket Drain(s).

"-F" Series Splash Mount Models Include K-159 3-1/2" Goosenecks. "-F" Series Deck Mount Models Include K-134 8-1/2" Goosenecks.

L	W	Bowl Size W x L x D	NO FAUCETS INCLUDED		MANUAL FAUCETS INCLUDED		ELECTRONIC OPERATED FAUCETS		KNEE OPERATED FAUCETS		# of Faucets
			Splash Mount	Price	Splash Mount	Price	Splash Mount	Price	Splash Mount	Price	
40"	19.5"	16" x 37" x 8"	FC-WM-40	\$5188	FC-WM-40-F	\$5914	FC-WM-40EF	\$8597	FC-WM-40KV	\$7040	2
48"	19.5"	16" x 45" x 8"	FC-WM-48	5525	FC-WM-48-F	6251	FC-WM-48EF	8934	FC-WM-48KV	7377	2
60"	19.5"	16" x 57" x 8"	FC-WM-60	5855	FC-WM-60-F	6948	FC-WM-60EF	10973	FC-WM-60KV	8633	3
72"	19.5"	16" x 69" x 8"	FC-WM-72	6220	FC-WM-72-F	7313	FC-WM-72EF	10973	FC-WM-72KV	8998	3
80"	19.5"	16" x 77" x 8"	FC-WM-80	6860	FC-WM-80-F	9417	FC-WM-80EF	13683	FC-WM-80KV	10564	4
96"	19.5"	16" x 93" x 8"	FC-WM-96	7225	FC-WM-96-F	9782	FC-WM-96EF	14048	FC-WM96KV	10929	4
100"	19.5"	16" x 97" x 8"	FC-WM-100	7697	FC-WM-100-F	9514	FC-WM-100EF	16224	FC-WM-100KV	12324	5
120"	19.5"	16" x 117" x 8"	FC-WM-120	9205	FC-WM-120-F	11384	FC-WM-120EF	19437	FC-WM-120KV	14758	6



### 16 GAUGE, 304 STAINLESS STEEL A.D.A. SINKS WITH TUBULAR SUPPORTS

• 5" Bowl Depth • 8 1/2" High Backsplash • 8" O.C. Faucet Holes on Manual Operated or Single Holes on Electronic Faucet Operated • Rear 3 1/2" Basket Drain(s).

"-F" Series Splash Mount Models Include K-161-LU 6" Goosenecks. "-F" Series Deck Mount Models Include K-134 8-1/2" Goosenecks.

L	W	Bowl Size W x L x D	NO FAUCETS INCLUDED		MANUAL FAUCETS INCLUDED		ELECTRONIC OPERATED FAUCETS		# of Faucets
			Splash Mount	Price	Splash Mount	Price	Splash Mount	Price	
40"	19.5"	16" x 37" x 5"	FC-WM-40-ADA	\$5138	FC-WM-40-ADA-F	\$5864	FC-WM-40EFADA	\$8547	2
48"	19.5"	16" x 45" x 5"	FC-WM-48-ADA	5475	FC-WM-48-ADA-F	6201	FC-WM-48EFADA	8884	2
60"	19.5"	16" x 57" x 5"	FC-WM-60-ADA	5805	FC-WM-60-ADA-F	6898	FC-WM-60EFADA	10923	3
72"	19.5"	16" x 69" x 5"	FC-WM-72-ADA	6170	FC-WM-72-ADA-F	7263	FC-WM-72EFADA	11338	3
80"	19.5"	16" x 77" x 5"	FC-WM-80-ADA	6810	FC-WM-80-ADA-F	9367	FC-WM-80EFADA	13633	4
96"	19.5"	16" x 93" x 5"	FC-WM-96-ADA	7175	FC-WM-96-ADA-F	9732	FC-WM-96EFADA	13998	4
100"	19.5"	16" x 97" x 5"	FC-WM-100-ADA	7647	FC-WM-100-ADA-F	9464	FC-WM-100EFADA	16058	5
120"	19.5"	16" x 117" x 5"	FC-WM-120-ADA	9155	FC-WM-120-ADA-F	11334	FC-WM-120EFADA	19269	6



FC-WM-40EFADA Shown

†Add K-472 For  
Faucet Hole Revision **\$185**

**WARNING:** Equipment that include faucets on this page may contain a chemical known to the State of California to cause cancer, birth defects or other reproductive harm.

 = Ships Via UPS



# SERVICE SINKS

## NSF Service Sinks

### 14 GAUGE, 304 STAINLESS STEEL SERVICE SINKS WITH TUBULAR SUPPORTS OR LEGS

10" or 12" Bowl Depth • 8-1/2" High Backsplash • 8" O.C. Faucet Holes on Manual Operated, Single Holes on Knee or Electronic Operated • 3 1/2" Basket Drain(s).  
 "-F" Series Splash Mount Models Include K-159 3-1/2" Gooseneck. "-F" Series Deck Mount Models Include K-134 8-1/2" Gooseneck.



FS-WM-2219 Shown

FS-WM-2219-F Shown

FS-WM-2219EF Shown

FS-WM-2219KV Shown

L	W	Bowl Size W x L x D	NO FAUCET INCLUDED		MANUAL FAUCET INCLUDED		ELECTRONIC OPERATED FAUCET		KNEE OPERATED FAUCET	
			Splash Mount	Price	Splash Mount	Price	Splash Mount	Price	Splash Mount	Price
23"	23"	19 1/2" x 20" x 10"*	FS-WM-2219†	\$3238	FS-WM-2219-F	\$3488	FS-WM-2219EF	\$4946	FS-WM-2219KV*	\$4165
27"	21.5"	18" x 24" x 10"*	FS-WM-2721†	3447	FS-WM-2721-F	3685	FS-WM-2721EF	5151	FS-WM-2721KV*	4371
31"	23"	16" x 28 x 12"*	FS-WM-3119†	3791	FS-WM-3119-F	4055	FS-WM-3119EF	5665	FS-WM-3119KV*	4809

\*Knee Valve Unit Has 8" Bowl Depth



### 14 GAUGE, 304 STAINLESS STEEL A.D.A. SERVICE SINKS WITH TUBULAR SUPPORTS

5" Bowl Depth • 8-1/2" High Backsplash • Stainless Steel Tubular Supports • 8" O.C. Faucet Holes on Manual Operated, Single Hole on Electronic Operated • 3 1/2" Basket Drain.  
 "-F" Series Splash Mount Models Include K-161-LU 6" Gooseneck. "-F" Series Deck Mount Models Include K-134 8-1/2" Gooseneck.

L	W	Bowl Size W x L x D	NO FAUCET INCLUDED		MANUAL FAUCET INCLUDED		ELECTRONIC OPERATED FAUCET	
			Splash Mount	Price	Splash Mount	Price	Splash Mount	Price
40"	19.5"	19 1/2" x 37" x 5"	FS-WM-1-ADA†	\$5363	FS-WM-1-ADA-F	\$5602	FS-WM-1-EFADA	\$7068

†Add K-472 For Faucet Hole Revision \$185



FS-WM-1-EFADA Shown

### 16 GAUGE, 304 STAINLESS STEEL SERVICE SINKS WITH TUBULAR SUPPORTS OR LEGS

10" or 12" Bowl Depth • 8-1/2" High Backsplash • 8" O.C. Faucet Holes on Manual Operated, Single Holes on Knee or Electronic Operated • 3 1/2" Basket Drain(s).  
 "-F" Series Splash Mount Models Include K-159 3-1/2" Gooseneck. "-F" Series Deck Mount Models Include K-134 8-1/2" Gooseneck.



FC-WM-2219 Shown

FC-WM-2219-F Shown

FC-WM-2219EF Shown

FC-WM-2219KV Shown

L	W	Bowl Size W x L x D	NO FAUCET INCLUDED		MANUAL FAUCET INCLUDED		ELECTRONIC OPERATED FAUCET		KNEE OPERATED FAUCET	
			Splash Mount	Price	Splash Mount	Price	Splash Mount	Price	Splash Mount	Price
23"	23"	19 1/2" x 20" x 10"*	FC-WM-2219†	\$2875	FC-WM-2219-F	\$3297	FC-WM-2219EF	\$4582	FC-WM-2219KV*	\$3805
27"	21.5"	18" x 24" x 10"*	FC-WM-2721†	3028	FC-WM-2721-F	3451	FC-WM-2721EF	4733	FC-WM-2721KV*	3953
31"	23"	16" x 28 x 12"*	FC-WM-3119†	3337	FC-WM-3119-F	3799	FC-WM-3119EF	5206	FC-WM-3119KV*	4351

\*Knee Valve Unit Has 8" Bowl Depth



### 16 GAUGE, 304 STAINLESS STEEL A.D.A. SERVICE SINKS WITH TUBULAR SUPPORTS

5" Bowl Depth • 8-1/2" High Backsplash • Stainless Steel Tubular Supports • 8" O.C. Faucet Holes on Manual Operated, Single Hole on Electronic Operated • 3 1/2" Basket Drain.  
 "-F" Series Splash Mount Models Include K-161-LU 6" Gooseneck. "-F" Series Deck Mount Models Include K-134 8-1/2" Gooseneck.

L	W	Bowl Size W x L x D	NO FAUCET INCLUDED		MANUAL FAUCET INCLUDED		ELECTRONIC OPERATED FAUCET	
			Splash Mount	Price	Splash Mount	Price	Splash Mount	Price
40"	19.5"	19 1/2" x 37" x 5"	FC-WM-1-ADA†	\$5085	FC-WM-1-ADA-F	\$5484	FC-WM-1-EFADA	\$6794

†Add K-472 For Faucet Hole Revision \$185



FC-WM-1-ADA Shown

**WARNING:** Equipment that include faucets on this page may contain a chemical known to the State of California to cause cancer, birth defects or other reproductive harm.

# MULTI-STATIONS

## Square Corner Multi-Stations

 = Ships Via UPS

### 16 GAUGE, 304 STAINLESS STEEL MULTI-STATIONS WITH TUBULAR SUPPORTS OR LEGS

8" Bowl Depth • 8 1/2" High Backsplash • 8" O.C. Faucet Holes on Manual Operated, Single Holes on Knee or Electronic Operated • 3 1/2" Basket Drain(s).



19-18-40 Shown



19-18-40EF Shown



Hands-Free  
Electronic Faucet



19-18-40-F Shown



K-159 3-1/2" Gooseneck  
Faucets Included  
On "-F" Models



19-18-40KV Shown



Knee Valve

L	W	Bowl Size W x L x D	NO FAUCETS INCLUDED		MANUAL FAUCETS INCLUDED		ELECTRONIC OPERATED FAUCETS		KNEE OPERATED FAUCETS		# of Faucets	Wt.	Cu. Ft.
			Model #	Price	Model #	Price	Model #	Price	Model #	Price			
23"	19.5"	16" x 23" x 8"	19-18-23 <sup>†</sup>	\$2606	19-18-23-F	\$2967	19-18-23EF	\$4406	19-18-23KV	\$3628	1	50 lbs.	10
40"	19.5"	16" x 40" x 8"	19-18-40 <sup>†</sup>	4187	19-18-40-F	4914	19-18-40EF	7597	19-18-40KV	6037	2	60 lbs.	15
48"	19.5"	16" x 48" x 8"	19-18-48 <sup>†</sup>	4524	19-18-48-F	5251	19-18-48EF	7934	19-18-48KV	6374	2	60 lbs.	15
60"	19.5"	16" x 60" x 8"	19-18-60 <sup>†</sup>	4946	19-18-60-F	6035	19-18-60EF	10062	19-18-60KV	7722	3	70 lbs.	18
72"	19.5"	16" x 72" x 8"	19-18-72 <sup>†</sup>	5311	19-18-72-F	6400	19-18-72EF	10427	19-18-72KV	8086	3	70 lbs.	18
80"	19.5"	16" x 80" x 8"	19-18-80 <sup>†</sup>	5514	19-18-80-F	6969	19-18-80EF	12338	19-18-80KV	9217	4	90 lbs.	22
96"	19.5"	16" x 96" x 8"	19-18-96 <sup>†</sup>	5879	19-18-96-F	7334	19-18-96EF	14804	19-18-96KV	12703	4	90 lbs.	22
100"	19.5"	16" x 100" x 8"	19-18-100 <sup>†</sup>	6276	19-18-100-F	8092	19-18-100EF	14804	19-18-100KV	10904	5	120 lbs.	30
120"	19.5"	16" x 120" x 8"	19-18-120 <sup>†</sup>	7850	19-18-120-F	10029	19-18-120EF	18082	19-18-120KV	13402	6	155 lbs.	36

<sup>†</sup>Add K-472 For Faucet Hole Revision \$185



### 16 GAUGE, 304 STAINLESS STEEL A.D.A. MULTI-STATIONS WITH TUBULAR SUPPORTS

5" Bowl Depth • 8 1/2" High Backsplash • 8" O.C. Faucet Holes on Manual Operated or Single Holes on Electronic Faucet Operated • Rear 3 1/2" Basket Drain(s)



19-18-40-ADA Shown



19-18-40-ADA-F Shown

K-161-LU 6" Gooseneck  
Faucets Included  
On "-F" Models



19-18-40-EFADA Shown

Hands-Free  
Electronic Faucet

L	W	Bowl Size W x L x D	NO FAUCETS INCLUDED		MANUAL FAUCETS INCLUDED		ELECTRONIC OPERATED FAUCETS		# of Faucets	Wt.	Cu. Ft.
			Model #	Price	Model #	Price	Model #	Price			
40"	19.5"	16" x 40" x 5"	19-18-40-ADA <sup>†</sup>	\$4137	19-18-40-ADA-F	\$4864	19-18-40EFADA	\$7547	2	60 lbs.	15
48"	19.5"	16" x 48" x 5"	19-18-48-ADA <sup>†</sup>	4474	19-18-48-ADA-F	5200	19-18-48EFADA	7884	2	66 lbs.	15
60"	19.5"	16" x 60" x 5"	19-18-60-ADA <sup>†</sup>	4896	19-18-60-ADA-F	5985	19-18-60EFADA	10012	3	70 lbs.	18
72"	19.5"	16" x 72" x 5"	19-18-72-ADA <sup>†</sup>	5261	19-18-72-ADA-F	6350	19-18-72EFADA	10377	3	76 lbs.	18
80"	19.5"	16" x 80" x 5"	19-18-80-ADA <sup>†</sup>	5464	19-18-80-ADA-F	6919	19-18-80EFADA	12288	4	100 lbs.	22
96"	19.5"	16" x 96" x 5"	19-18-96-ADA <sup>†</sup>	5829	19-18-96-ADA-F	7284	19-18-96EFADA	12653	4	120 lbs.	22
100"	19.5"	16" x 100" x 5"	19-18-100-ADA <sup>†</sup>	6226	19-18-100-ADA-F	8042	19-18-100EFADA	14754	5	130 lbs.	30
120"	19.5"	16" x 120" x 5"	19-18-120-ADA <sup>†</sup>	7800	19-18-120-ADA-F	9979	19-18-120EFADA	18032	6	165 lbs.	36

<sup>†</sup>Add K-472 For Faucet Hole Revision \$185

# SERVICE SINKS

## Square Corner Service Sinks

### 16 GAUGE, 304 STAINLESS STEEL SERVICE SINKS WITH TUBULAR SUPPORTS OR LEGS

12" Bowl Depth (Excludes Knee Valve Units\*) • 8 1/2" High Backsplash • 8" O.C. Faucet Holes on Manual Operated, Single Holes on Knee or Electronic Operated • 3 1/2" Basket Drain(s)



WSS-14-21 Shown

WSS-14-21-F Shown

WSS-14-21EF Shown

WSS-14-21KV Shown

L	W	Bowl Size W x L x D	NO FAUCET INCLUDED		MANUAL FAUCET INCLUDED		ELECTRONIC OPERATED FAUCETS		KNEE OPERATED FAUCETS		Cu. Ft.	
			Model #	Price	Model #	Price	Model #	Price	Model #	Price		Wt.
18"	17.5"	14" x 18" x 12"*	WSS-14-21†	\$2739	WSS-14-21-F	\$3103	WSS-14-21EF	\$4444	WSS-14-21KV*	\$3665	45 lbs.	8
22"	19.5"	16 x 22" x 12"*	WSS-16-25†	3025	WSS-16-25-F	3388	WSS-16-25EF	4730	WSS-16-25KV*	3951	52 lbs.	10
31"	19.5"	16" x 31" x 12"*	WSS-16-31†	3326	WSS-16-31-F	3727	WSS-16-31EF	5206	WSS-16-31KV*	4347	75 lbs.	14

\*Add K-472 For Faucet Hole Revision \$185

\*Knee Valve Unit Has 8" Bowl Depth



### 16 GAUGE, 304 STAINLESS STEEL A.D.A. SERVICE SINKS WITH TUBULAR SUPPORTS

5" Bowl Depth • 8 1/2" High Backsplash • 8" O.C. Faucet Holes on Manual Operated, Single Holes on Electronic Operated • Rear 3 1/2" Basket Drain



19-18-1-ADA Shown

19-18-1-ADA-F Shown

19-18-1-EFADA Shown

L	W	Bowl Size W x L x D	NO FAUCET INCLUDED		MANUAL FAUCET INCLUDED		ELECTRONIC OPERATED FAUCETS		Cu. Ft.	
			Model #	Price	Model #	Price	Model #	Price		Wt.
40"	19.5"	16" x 37" x 5"	19-18-1-ADA†	\$4182	19-18-1-ADA-F	\$4703	19-18-1-EFADA	\$5807	60 lbs.	15

\*Add K-472 For Faucet Hole Revision \$185

### MULTI-STATION HAND SINK ACCESSORIES & MODIFICATIONS



Model	Description	Price	Model	Description	Price
K-6	3 1/2" Drain (1 1/2" I.P.S.)	\$67 ea.	K-1118	H.D. 8" Splash Mounted Faucet	563 ea.
K-13	Stainless Steel Soap Dispenser	604 ea.	K-316-LU	Wrist Handles	175 pair
K-101	8" Swing Spout Splash Mt. Faucet	332 ea.	K-472	Faucet Hole Revision (Manual Faucet Operated Sinks Only)	185
K-121	Single Hole, Splash Mounted 3-1/2" Gooseneck Spout	207 ea.	K-449	Reduce rear splash on ADA multi-station hand sink or service sink to 5" tall (top of splash 39" AFF if installed at ADA working height, allows ADA compliant mirror (by others) to be mounted over sink)	N/C
K-134	H.D. Deck Mounted 8-1/2" Gooseneck Faucet (8" O.C.)	904 ea.	K-508	Special Sizing Charge (Larger Size Cut Down To Smaller Size)	N/C
K-159	H.D. Splash Mounted 3-1/2" Gooseneck Faucet (8" O.C.)	659 ea.	TA-19	Adjustable Stainless Steel Flanged Bullet Foot	85 ea.
K-161-LU	H.D. Splash Mounted 6" Gooseneck Faucet (8" O.C.) With Wrist Handles	735 ea.			
K-411	Strainer Plate for 3-1/2" Drain	35 ea.			

**WARNING:** Equipment that includes a faucet may expose you to chemicals, including lead, that are known to the State of California to cause cancer or birth defects or other reproductive harm. For more info., visit [www.p65warnings.ca.gov](http://www.p65warnings.ca.gov).

# MULTI-STATIONS

## NSF Multi-Stations



= Ships Via UPS

### 14 GA., 304 STAINLESS STEEL SINKS w/STAINLESS STEEL LEGS & FLANGED FEET

8" Bowl Depth • 8 1/2" High Backsplash • 8" O.C. Faucet Holes on Manual Operated, Single Holes on Knee/Toe-Push or Electronic Operated  
 • Stainless Steel Flanged Feet • Wall Support Bracket • Side & Rear Cross-Bracing • 3 1/2" Basket Drain(s).

"-F" Series Splash Mount Models Include K-159 3-1/2" Goosenecks. "-F" Series Deck Mount Models Include K-134 8-1/2" Goosenecks.



FS-FM-40 Shown

FS-FM-40-F Shown

FS-FM-40EF Shown

FS-FM-40KV Shown

FS-FM-40FV Shown

L	W	Bowl Size W x L x D	NO FAUCETS INCLUDED		MANUAL FAUCETS INCLUDED		ELECTRONIC OPERATED FAUCETS		KNEE OPERATED FAUCETS		TOE-PUSH OPERATED FAUCETS		# of Faucets
			Splash Mount	Price	Splash Mount	Price	Splash Mount	Price	Splash Mount	Price	Splash Mount	Price	
			40"	19.5"	16" x 37" x 8"	FS-FM-40 <sup>†</sup>	\$6609	FS-FM-40-F	\$7335	FS-FM-40EF	\$10027	FS-FM-40KV	
48"	19.5"	16" x 45" x 8"	FS-FM-48 <sup>†</sup>	6946	FS-FM-48-F	7672	FS-FM-48EF	10364	FS-FM-48KV	8803	FS-FM-48FV	9265	2
60"	19.5"	16" x 57" x 8"	FS-FM-60 <sup>†</sup>	7432	FS-FM-60-F	8523	FS-FM-60EF	12549	FS-FM-60KV	9921	FS-FM-60FV	10209	3
72"	19.5"	16" x 69" x 8"	FS-FM-72 <sup>†</sup>	7796	FS-FM-72-F	8888	FS-FM-72EF	12914	FS-FM-72KV	10286	FS-FM-72FV	10574	3
80"	19.5"	16" x 77" x 8"	FS-FM-80 <sup>†</sup>	8477	FS-FM-80-F	9929	FS-FM-80EF	15299	FS-FM-80KV	11814	FS-FM-80FV	12179	4
96"	19.5"	16" x 93" x 8"	FS-FM-96 <sup>†</sup>	8842	FS-FM-96-F	10294	FS-FM-96EF	15664	FS-FM-96KV	12179	FS-FM-96FV	12544	4
100"	19.5"	16" x 97" x 8"	FS-FM-100 <sup>†</sup>	9511	FS-FM-100-F	11328	FS-FM-100EF	18041	FS-FM-100KV	13776	FS-FM-100FV	14142	5
120"	19.5"	16" x 117" x 8"	FS-FM-120 <sup>†</sup>	11982	FS-FM-120-F	14164	FS-FM-120EF	22217	FS-FM-120KV	16952	FS-FM-120FV	17537	6

### 14 GA., 304 STAINLESS STEEL A.D.A. SINKS w/STAINLESS STEEL LEGS & FLANGED FEET



5" Bowl Depth • 8 1/2" High Backsplash • 8" O.C. Faucet Holes on Manual Operated or Single Holes on Electronic Faucet Operated  
 • Stainless Steel Flanged Feet • Wall Support Bracket • Rear Cross-Bracing • 3 1/2" Basket Drain(s).

"-F" Series Splash Mount Models Include K-161-LU 6" Goosenecks. "-F" Series Deck Mount Models Include K-134 8-1/2" Goosenecks.

L	W	Bowl Size W x L x D	NO FAUCETS INCLUDED		MANUAL FAUCETS INCLUDED		ELECTRONIC OPERATED FAUCETS		# of Faucets
			Splash Mount	Price	Splash Mount	Price	Splash Mount	Price	
			40"	19.5"	16" x 37" x 5"	FS-FM-40-ADA <sup>†</sup>	\$6559	FS-FM-40-ADA-F	
48"	19.5"	16" x 45" x 5"	FS-FM-48-ADA <sup>†</sup>	6896	FS-FM-48-ADA-F	7622	FS-FM-48EFADA	10314	2
60"	19.5"	16" x 57" x 5"	FS-FM-60-ADA <sup>†</sup>	7382	FS-FM-60-ADA-F	8473	FS-FM-60EFADA	12499	3
72"	19.5"	16" x 69" x 5"	FS-FM-72-ADA <sup>†</sup>	7746	FS-FM-72-ADA-F	8838	FS-FM-72EFADA	12864	3
80"	19.5"	16" x 77" x 5"	FS-FM-80-ADA <sup>†</sup>	8427	FS-FM-80-ADA-F	9879	FS-FM-80EFADA	15249	4
96"	19.5"	16" x 93" x 5"	FS-FM-96-ADA <sup>†</sup>	8792	FS-FM-96-ADA-F	10244	FS-FM-96EFADA	15614	4
100"	19.5"	16" x 97" x 5"	FS-FM-100-ADA <sup>†</sup>	9461	FS-FM-100-ADA-F	11278	FS-FM-100EFADA	17991	5
120"	19.5"	16" x 117" x 5"	FS-FM-120-ADA <sup>†</sup>	11932	FS-FM-120-ADA-F	14114	FS-FM-120EFADA	21786	6

<sup>†</sup>Add K-472 For Faucet Hole Revision \$185



FS-FM-40EFADA Shown

### 16 GA., 304 STAINLESS STEEL SINKS WITH STAINLESS STEEL LEGS & FLANGED FEET

8" Bowl Depth • 8 1/2" High Backsplash • 8" O.C. Faucet Holes on Manual Operated, Single Holes on Knee/Toe-Push or Electronic Operated  
 • Stainless Steel Flanged Feet • Wall Support Bracket • Side & Rear Cross-Bracing • 3 1/2" Basket Drain(s).

"-F" Series Splash Mount Models Include K-159 3-1/2" Goosenecks. "-F" Series Deck Mount Models Include K-134 8-1/2" Goosenecks.

L	W	Bowl Size W x L x D	NO FAUCETS INCLUDED		MANUAL FAUCETS INCLUDED		ELECTRONIC OPERATED FAUCETS		KNEE OPERATED FAUCETS		TOE-PUSH OPERATED FAUCETS		# of Faucets
			Splash Mount	Price	Splash Mount	Price	Splash Mount	Price	Splash Mount	Price	Splash Mount	Price	
			40"	19.5"	16" x 37" x 8"	FC-FM-40 <sup>†</sup>	\$5798	FC-FM-40-F	\$6523	FC-FM-40EF	\$9208	FC-FM-40KV	
48"	19.5"	16" x 45" x 8"	FC-FM-48 <sup>†</sup>	6135	FC-FM-48-F	6860	FC-FM-48EF	9545	FC-FM-48KV	7750	FC-FM-48FV	7985	2
60"	19.5"	16" x 57" x 8"	FC-FM-60 <sup>†</sup>	6619	FC-FM-60-F	7708	FC-FM-60EF	11734	FC-FM-60KV	8910	FC-FM-60FV	9394	3
72"	19.5"	16" x 69" x 8"	FC-FM-72 <sup>†</sup>	6619	FC-FM-72-F	7708	FC-FM-72EF	11734	FC-FM-72KV	8910	FC-FM-72FV	9394	3
80"	19.5"	16" x 77" x 8"	FC-FM-80 <sup>†</sup>	7773	FC-FM-80-F	92527	FC-FM-80EF	14596	FC-FM-80KV	10822	FC-FM-80FV	11477	4
96"	19.5"	16" x 93" x 8"	FC-FM-96 <sup>†</sup>	8138	FC-FM-96-F	9592	FC-FM-96EF	14961	FC-FM-96KV	11187	FC-FM-96FV	11842	4
100"	19.5"	16" x 97" x 8"	FC-FM-100 <sup>†</sup>	8916	FC-FM-100-F	10732	FC-FM-100EF	17443	FC-FM-100KV	12570	FC-FM-100FV	13544	5
120"	19.5"	16" x 117" x 8"	FC-FM-120 <sup>†</sup>	10727	FC-FM-120-F	12907	FC-FM-120EF	20962	FC-FM-120KV	14969	FC-FM-120FV	16282	6

### 16 GA., 304 STAINLESS STEEL A.D.A. SINKS w/STAINLESS STEEL LEGS & FLANGED FEET



5" Bowl Depth • 8 1/2" High Backsplash • 8" O.C. Faucet Holes on Manual Operated or Single Holes on Electronic Faucet Operated  
 • Stainless Steel Flanged Feet • Wall Support Bracket • Rear Cross-Bracing • 3 1/2" Basket Drain(s).

"-F" Series Splash Mount Models Include K-161-LU 6" Goosenecks. "-F" Series Deck Mount Models Include K-134 8-1/2" Goosenecks.

L	W	Bowl Size W x L x D	NO FAUCETS INCLUDED		MANUAL FAUCETS INCLUDED		ELECTRONIC OPERATED FAUCETS		# of Faucets
			Splash Mount	Price	Splash Mount	Price	Splash Mount	Price	
			40"	19.5"	16" x 37" x 5"	FC-FM-40-ADA <sup>†</sup>	\$5748	FC-FM-40-ADA-F	
48"	19.5"	16" x 45" x 5"	FC-FM-48-ADA <sup>†</sup>	6085	FC-FM-48-ADA-F	6810	FC-FM-48EFADA	9495	2
60"	19.5"	16" x 57" x 5"	FC-FM-60-ADA <sup>†</sup>	6569	FC-FM-60-ADA-F	7658	FC-FM-60EFADA	11684	3
72"	19.5"	16" x 69" x 5"	FC-FM-72-ADA <sup>†</sup>	6934	FC-FM-72-ADA-F	8023	FC-FM-72EFADA	12049	3
80"	19.5"	16" x 77" x 5"	FC-FM-80-ADA <sup>†</sup>	7723	FC-FM-80-ADA-F	9177	FC-FM-80EFADA	14546	4
96"	19.5"	16" x 93" x 5"	FC-FM-96-ADA <sup>†</sup>	8088	FC-FM96-ADA-F	9542	FC-FM-96EFADA	14911	4
100"	19.5"	16" x 97" x 5"	FC-FM-100-ADA <sup>†</sup>	8866	FC-FM-100-ADA-F	10682	FC-FM-100EFADA	17393	5
120"	19.5"	16" x 117" x 5"	FC-FM-120-ADA <sup>†</sup>	10677	FC-FM-120-ADA-F	12857	FC-FM-120EFADA	20912	6



FC-FM-40-EFADA Shown

<sup>†</sup>Add K-472 For Faucet Hole Revision \$185

 = Ships Via UPS



# SERVICE SINKS

## NSF Service Sinks

### 14 GA., 304 STAINLESS STEEL SERVICE SINKS w/STAINLESS STEEL LEGS & FLANGED FEET

10" or 12" Bowl Depth • 8-1/2" High Backsplash • 8" O.C. Faucet Holes on Manual Operated, Single Holes on Knee/Toe-Push or Electronic Operated  
 • Stainless Steel Flanged Feet • Wall Support Bracket • Side & Rear Cross-Bracing 3 1/2" Basket Drain(s)  
 "F" Series Splash Mount Models Include K-159 3-1/2" Gooseneck. "F" Series Deck Mount Models Include K-134 8-1/2" Gooseneck.



FS-FM-2219 Shown



FS-FM-2219-F Shown



FS-FM-2219EF Shown



FS-FM-2219KV Shown



FS-FM-2219FV Shown

L	W	Bowl Size W x L x D	NO FAUCET INCLUDED		MANUAL FAUCETS INCLUDED		ELECTRONIC OPERATED FAUCETS		KNEE OPERATED FAUCETS		TOE-PUSH OPERATED FAUCETS	
			Splash Mount	Price	Splash Mount	Price	Splash Mount	Price	Splash Mount	Price	Splash Mount	Price
23"	23"	19 1/2" x 20" x 10"*	FS-FM-2219†	\$3840	FS-FM-2219-F	\$4261	FS-FM-2219EF	\$5545	FS-FM-2219KV*	\$4767	FS-FM-2219FV	\$5237
27"	21.5"	18" x 24" x 10"*	FS-FM-2721†	4046	FS-FM-2721-F	4467	FS-FM-2721EF	5751	FS-FM-2721KV*	4971	FS-FM-2721FV	5444
31"	23"	16" x 28" x 12"*	FS-FM-3119†	4450	FS-FM-3119-F	4916	FS-FM-3119EF	6327	FS-FM-3119KV*	5471	FS-FM-3119FV	5986

\*Knee Valve Unit Has 8" Bowl Depth

### 14 GA., 304 STAINLESS STEEL A.D.A. SERVICE SINKS w/STAINLESS STEEL LEGS & FLANGED FEET



5" Bowl Depth • 8-1/2" High Backsplash • 8" O.C. Faucet Holes on Manual Operated, Single Hole on Electronic Operated  
 • Stainless Steel Flanged Feet • Wall Support Bracket • Rear Cross-Bracing • 3 1/2" Basket Drain(s).

"F" Series Splash Mount Models Include K-161-LU 6" Gooseneck. "F" Series Deck Mount Models Include K-134 8-1/2" Gooseneck.

L	W	Bowl Size W x L x D	NO FAUCET INCLUDED		MANUAL FAUCET INCLUDED		ELECTRONIC OPERATED FAUCET	
			Splash Mount	Price	Deck Mount	Price	Splash Mount	Price
40"	19.5"	19 1/2" x 37" x 5"	FS-FM-1-ADA†	\$5840	FS-FM-1-ADA-F	\$6361	FS-FM-1-EFADA	\$7545

†Add K-472 For Faucet Hole Revision \$185



FS-FM-1-ADA Shown

### 16 GA., 304 STAINLESS STEEL SERVICE SINKS w/STAINLESS STEEL LEGS & FLANGED FEET

10" or 12" Bowl Depth • 8-1/2" High Backsplash • 8" O.C. Faucet Holes on Manual Operated, Single Holes on Knee/Toe-Push or Electronic Operated  
 • Stainless Steel Flanged Feet • Wall Support Bracket • Side & Rear Cross-Bracing • 3 1/2" Basket Drain(s).

Gooseneck Faucet Included On "F" Series Sinks. Splash Mt. Models Include 3-1/2" Gooseneck, Deck Mt. Models Include 6" Gooseneck.



FC-FM-2219 Shown



FC-FM-2219-F Shown



FC-FM-2219EF Shown



FC-FM-2219KV Shown



FC-FM-2219FV Shown



Toe-Push Valve

L	W	Bowl Size W x L x D	NO FAUCET INCLUDED		MANUAL FAUCET INCLUDED		ELECTRONIC OPERATED FAUCET		KNEE OPERATED FAUCET		TOE-PUSH OPERATED FAUCETS	
			Splash Mount	Price	Splash Mount	Price	Splash Mount	Price	Splash Mount	Price	Splash Mount	Price
23"	23"	19 1/2" x 20" x 10"*	FC-FM-2219†	\$3478	FC-FM-2219-F	\$3900	FC-FM-2219EF	\$5182	FC-FM-2219KV*	\$4274	FC-FM-2219FV	\$4844
27"	21.5"	18" x 24" x 10"*	FC-FM-2721†	3630	FC-FM-2721-F	4052	FC-FM-2721EF	5333	FC-FM-2721KV*	4554	FC-FM-2721FV	5001
31"	23"	16" x 28" x 12"*	FC-FM-3119†	4450	FC-FM-3119-F	4458	FC-FM-3119EF	5009	FC-FM-3119KV*	5009	FC-FM-3119FV	5501

\*Knee Valve Unit Has 8" Bowl Depth

### 16 GA., 304 STAINLESS STEEL A.D.A. SERVICE SINKS w/STAINLESS STEEL LEGS & FLANGED FEET



5" Bowl Depth • 8-1/2" High Backsplash • 8" O.C. Faucet Holes on Manual Operated, Single Hole on Electronic Operated  
 • Stainless Steel Flanged Feet • Wall Support Bracket • Rear Cross-Bracing • 3 1/2" Basket Drain(s).

"F" Series Splash Mount Models Include K-161-LU 6" Gooseneck. "F" Series Deck Mount Models Include K-134 8-1/2" Gooseneck.

L	W	Bowl Size W x L x D	NO FAUCET INCLUDED		MANUAL FAUCET INCLUDED		ELECTRONIC OPERATED FAUCET	
			Splash Mount	Price	Splash Mount	Price	Model #	Price
40"	19.5"	19 1/2" x 37" x 5"	FC-FM-1-ADA†	\$5564	FC-FM-1-ADA-F	\$6084	FC-FM-1-EFADA	\$7269

†Add K-472 For Faucet Hole Revision \$185



FC-FM-1-EFADA Shown

**WARNING:** Equipment that include faucets on this page may contain a chemical known to the State of California to cause cancer, birth defects or other reproductive harm.

# MULTI-STATIONS

## Square Corner Multi-Stations

 = Ships Via UPS

### 16 GA., 304 STAINLESS STEEL MULTI-STATIONS W/STAINLESS STEEL LEGS & FLANGED FEET

8" Bowl Depth • 8 1/2" High Backsplash • 8" O.C. Faucet Holes on Manual Operated, Single Holes on Knee/Toe-Push or Electronic Operated  
 • Stainless Steel Flanged Feet • Wall Support Bracket • Side & Rear Cross-Bracing • 3 1/2" Basket Drain(s)



L	W	Bowl Size W x L x D	NO FAUCETS INCLUDED		MANUAL FAUCETS INCLUDED		ELECTRONIC OPERATED FAUCETS		KNEE OPERATED FAUCETS		TOE-PUSH OPERATED FAUCETS		# of Faucets
			Model #	Price	Model #	Price	Model #	Price	Model #	Price	Model #	Price	
23"	19.5"	16" x 23" x 8"	19-FM-23 <sup>†</sup>	\$3204	19-FM-23-F	\$3568	19-FM-23EF	\$5008	19-FM-23KV	\$4099	19-FM-23FV	\$4227	1
40"	19.5"	16" x 40" x 8"	19-FM-40 <sup>†</sup>	4795	19-FM-40-F	5521	19-FM-40EF	8205	19-FM-40KV	6411	19-FM-40FV	6645	2
48"	19.5"	16" x 48" x 8"	19-FM-48 <sup>†</sup>	5132	19-FM-48-F	5858	19-FM-48EF	8542	19-FM-48KV	6748	19-FM-48FV	6892	2
60"	19.5"	16" x 60" x 8"	19-FM-60 <sup>†</sup>	5705	19-FM-60-F	6796	19-FM-60EF	10822	19-FM-60KV	7999	19-FM-60FV	8481	3
72"	19.5"	16" x 72" x 8"	19-FM-72 <sup>†</sup>	6070	19-FM-72-F	7161	19-FM-72EF	11247	19-FM-72KV	8364	19-FM-72FV	8846	3
80"	19.5"	16" x 80" x 8"	19-FM-80 <sup>†</sup>	6273	19-FM-80-F	7726	19-FM-80EF	13248	19-FM-80-KV	9477	19-FM-80FV	10130	4
96"	19.5"	16" x 96" x 8"	19-FM-96 <sup>†</sup>	6637	19-FM-96-F	8091	19-FM-96EF	13613	19-FM-96KV	9842	19-FM-96FV	10130	4
100"	19.5"	16" x 100" x 8"	19-FM-100 <sup>†</sup>	7492	19-FM-100-F	9309	19-FM-100EF	16020	19-FM-100KV	11147	19-FM-100FV	12122	5
120"	19.5"	16" x 120" x 8"	19-FM-120 <sup>†</sup>	9372	19-FM-120-F	11552	19-FM-120EF	19608	19-FM-120KV	13614	19-FM-120FV	14929	6

<sup>†</sup>Add **K-472** For Faucet Hole Revision **\$185**

### 16 GAUGE, 304 STAINLESS STEEL A.D.A. MULTI-STATIONS WITH TUBULAR SUPPORTS



5" Bowl Depth • 8 1/2" High Backsplash • 8" O.C. Faucet Holes on Manual Operated or Single Holes on Electronic Faucet Operated  
 • Stainless Steel Flanged Feet • Wall Support Bracket • Rear Cross-Bracing • 3 1/2" Basket Drain(s)



L	W	Bowl Size W x L x D	NO FAUCETS INCLUDED		MANUAL FAUCETS INCLUDED		ELECTRONIC OPERATED FAUCETS		# of Faucets
			Model #	Price	Model #	Price	Model #	Price	
40"	19.5"	16" x 40" x 5"	19-FM-40-ADA <sup>†</sup>	\$4745	19-FM-40-ADA-F	\$5471	19-FM-40EFADA	\$8155	2
48"	19.5"	16" x 48" x 5"	19-FM-48-ADA <sup>†</sup>	5082	19-FM-40-ADA-F	5808	19-FM-48EFADA	8492	2
60"	19.5"	16" x 60" x 5"	19-FM-60-ADA <sup>†</sup>	5655	19-FM-60-ADA-F	6746	19-FM-60EFADA	10772	3
72"	19.5"	16" x 72" x 5"	19-FM-72-ADA <sup>†</sup>	6020	19-FM-72-ADA-F	7111	19-FM-72EFADA	11197	3
80"	19.5"	16" x 80" x 5"	19-FM-80-ADA <sup>†</sup>	6223	19-FM-80-ADA-F	7676	19-FM-80EFADA	13198	4
96"	19.5"	16" x 96" x 5"	19-FM-96-ADA <sup>†</sup>	6587	19-FM-96-ADA-F	8041	19-FM-96EFADA	13563	4
100"	19.5"	16" x 100" x 5"	19-FM-100-ADA <sup>†</sup>	7442	19-FM-100-ADA-F	9259	19-FM-100EFADA	15865	5
120"	19.5"	16" x 120" x 5"	19-FM-120-ADA <sup>†</sup>	9322	19-FM-120-ADA-F	11502	19-FM-120EFADA	19344	6

<sup>†</sup>Add **K-472** For Faucet Hole Revision **\$185**

# SERVICE SINKS

## Square Corner Service Sinks

### 16 GAUGE, 304 STAINLESS STEEL SERVICE SINKS W/STAINLESS STEEL LEGS & FLANGED FEET

12" Bowl Depth (Excludes Knee Valve Units)\* • 8 1/2" High Backsplash • 8" O.C. Faucet Holes on Manual Operated, Single Holes on Knee/Toe-Push or Electronic Operated  
 • Stainless Steel Flanged Feet • Wall Support Bracket • Side & Rear Cross-Bracing • 3 1/2" Basket Drain(s)



WSS-14-21-FM Shown



WSS-14-21-FM-F Shown



WSS-14-21EF-FM Shown



WSS-14-21KV-FM Shown



WSS-14-21FV-FM Shown



Toe-Push Valve

L	W	Bowl Size W x L x D	NO FAUCET INCLUDED		MANUAL FAUCET INCLUDED		ELECTRONIC OPERATED FAUCETS		KNEE OPERATED FAUCETS		TOE-PUSH OPERATED FAUCETS		Wt.
			Model #	Price	Model #	Price	Model #	Price	Model #	Price	Model #	Price	
18"	17.5"	14" x 18" x 12"*	WSS-14-21-FM†	\$3340	WSS-14-21-FM-F	\$3703	WSS-14-21EF-FM	\$5044	WSS-14-21KV-FM*	\$4135	WSS-14-21FV-FM	\$4265	45 lbs.
22"	22"	16 x 22" x 12"*	WSS-16-25-FM†	3626	WSS-16-25-FM-F	3988	WSS-16-25EF-FM	5331	WSS-16-25KV-FM*	4551	WSS-16-25FV-FM	5039	52 lbs.
31"	31"	16" x 31" x 12"*	WSS-16-31-FM†	3988	WSS-16-31-FM-F	4388	WSS-16-31EF-FM	5864	WSS-16-31KV-FM*	5008	WSS-16-31FV-FM	5544	58 lbs.

†Add **K-472** For Faucet Hole Revision **\$185**

\*Knee Valve Unit Has 8" Bowl Depth

### 16 GAUGE, 304 STAINLESS STEEL A.D.A. SERVICE SINKS WITH TUBULAR SUPPORTS



5" Bowl Depth • 8 1/2" High Backsplash • 8" O.C. Faucet Holes on Manual Operated, Single Holes on Electronic Operated  
 • Stainless Steel Flanged Feet • Wall Support Bracket • Rear Cross-Bracing • 3 1/2" Basket Drain(s)



19-FM-1-ADA Shown



19-FM-1-ADA-F Shown



19-FM-1-EFADA Shown

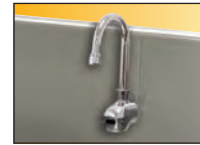

Hands-Free Electronic Faucet

L	W	Bowl Size W x L x D	NO FAUCET INCLUDED		MANUAL FAUCET INCLUDED		ELECTRONIC OPERATED FAUCET		Wt.
			Model #	Price	Model #	Price	Model #	Price	
40"	19.5"	16" x 40" x 12"	19-FM-1-ADA†	\$4659	19-FM-1-ADA-F†	\$5082	19-FM-1-EFADA	\$6283	60 lbs.

†Add **K-472** For Faucet Hole Revision **\$185**

### MULTI-STATION HAND SINK ACCESSORIES & MODIFICATIONS



K-6



K-161-LU



K-134



K-159



K-316



K-101



TA-19

Model	Description	Price	Model	Description	Price
K-6	3 1/2" Drain (1 1/2" I.P.S.)	\$67 ea.	K-1118	Extra H.D. 8" Splash Mounted Faucet	538 ea.
K-13	Stainless Steel Soap Dispenser	604 ea.	K-316-LU	Wrist Handles	175 pair
K-101	8" Swing Spout Splash Mt. Faucet	332 ea.	K-472	Faucet Hole Revision (Manual Faucet Operated Sinks Only)	185
K-121	Single Hole, Splash Mounted 3-1/2" Gooseneck Spout	207 ea.	K-449	Reduce rear splash on ADA multi-station hand sink or service sink to 5" tall (top of splash 39" AFF if installed at ADA working height, allows ADA compliant mirror (by others) to be mounted over sink)	N/C
K-134	Deck Mounted 8-1/2" Gooseneck Faucet (8" O.C.)	904 ea.	K-508	Special Sizing Charge (Larger Size Cut Down To Smaller Size)	N/C
K-159	Splash Mounted 3-1/2" Gooseneck Faucet (8" O.C.)	658 ea.	TA-19	Adjustable Stainless Steel Flanged Bullet Foot	82 ea.
K-161-LU	Splash Mounted 6" Gooseneck Faucet (8" O.C.) With Wrist Handles	734 ea.			
K-411	Strainer Plate for 3-1/2" Drain	34 ea.			

**WARNING:** Equipment that includes a faucet may expose you to chemicals, including lead, that are known to the State of California to cause cancer or birth defects or other reproductive harm. For more info., visit [www.p65warnings.ca.gov](http://www.p65warnings.ca.gov).

# REGALINE

## Deep Drawn Sinks



Deep Drawn Bowls Are Seamless And Drawn Out of a Single Sheet of Steel

ALL MODELS INCLUDE  
STAINLESS STEEL LEGS  
& BULLET FEET

Now All Adjustable Cross Bracing!



94 Series



93 & 9 Series

### Features and Benefits

- 3" Large Radius Corners
- Easy to Clean
- Satin Finish
- No Welded Seams



<h3>SPEC-LINE "94" Series</h3> <ul style="list-style-type: none"> <li>• 14 ga. 304 Stainless Steel</li> <li>• Stainless Steel Adjustable Cross Bracing On Front and Sides</li> <li>• 16 ga. 304 Stainless Steel Legs &amp; Bullet Feet</li> <li>• 11" Backsplash</li> <li>• 14" Deep Sink Bowls</li> </ul>	<p><b>THE ONLY 14 GAUGE Deep Drawn SINK!</b></p>	<h3>STANDARD "93" Series</h3> <ul style="list-style-type: none"> <li>• 16 ga. 304 Stainless Steel</li> <li>• Stainless Steel Adjustable Side Cross Bracing</li> <li>• Stainless Steel Legs and Bullet Feet</li> <li>• 8" Backsplash</li> <li>• 12" Deep Sink Bowls</li> </ul>	<h3>SUPERSAVER "9" Series</h3> <ul style="list-style-type: none"> <li>• 18 ga. 304 Stainless Steel</li> <li>• Stainless Steel Adjustable Side Cross Bracing</li> <li>• Stainless Steel Legs and Bullet Feet</li> <li>• 8" Backsplash</li> <li>• 12" Deep Sink Bowls</li> </ul>
--	--	---	--

## ONE, TWO, THREE AND FOUR COMPARTMENTS with No Drainboards



94 Series Shown



Spec-Line 94 Series

Standard 93 Series

Super Saver 9 Series

14 Ga. 304 S/S 14" Water Level	16 Ga. 304 S/S 12" Water Level	18 Ga. 304 S/S 12" Water Level
-----------------------------------	-----------------------------------	-----------------------------------

Bowl Size	O.A. Length	# of Comp.	Model #	Price	Approx. Wt. (lbs.)	Model #	Price	Approx. Wt. (lbs.)	Model #	Price	Approx. Wt. (lbs.)	Cu. Ft.
<b>16" x 20"</b>	27"	One	94-1-24	\$5674	77	93-1-24	\$3688	62	9-1-24	\$3383	54	20
	46"	Two	94-2-36	7364	109	93-2-36	5056	76	9-2-36	4633	66	20
	64"	Three	94-3-54	9098	142	93-3-54	6401	107	9-3-54	5866	95	28
	*83"	Four	94-4-72	11633	225	93-4-72	8276	176	9-4-72	7596	155	44
<b>20" x 20"</b>	31"	One	94-21-20	6199	92	93-21-20	4020	80	9-21-20	3960	61	20
	54"	Two	94-22-40	8085	116	93-22-40	5563	92	9-22-40	5101	79	23
	76"	Three	94-23-60	10407	232	93-23-60	7373	188	9-23-60	6757	169	44
	*99"	Four	94-24-80	13081	285	93-24-80	9420	210	9-24-80	8663	192	56
<b>24" x 24"</b>	35"	One	94-41-24	6641	97	93-41-24	4657	85	9-41-24	4274	80	23
	62"	Two	94-42-48	9609	174	93-42-48	7018	145	9-42-48	6437	133	31
	*88"	Three	94-43-72	12105	252	93-43-72	9190	213	9-43-72	8429	200	56
	*115"	Four	94-44-96	15047	347	93-44-96	11794	302	9-44-96	10807	281	74
<b>20" x 28"</b>	31"	One	94-81-20	7321	134	93-81-20	4847	94	9-81-20	4431	82	27
	54"	Two	94-82-40	9634	176	93-82-40	7118	150	9-82-40	6524	138	45
	76"	Three	94-83-60	12471	255	93-83-60	9505	225	9-83-60	8711	216	65
	*99"	Four	94-84-80	15914	345	93-84-80	12288	310	9-84-80	11251	287	78

\* Requires Two Faucets

Weights and Cubes are approximate

See pages 37 and 38 for faucets, accessories, and modifications.



# REGALINE

## Deep Drawn Sinks



94 Series Shown

### ONE COMPARTMENT WITH TWO DRAINBOARDS

#### Spec-Line 94 Series

#### Standard 93 Series

#### Super Saver 9 Series

Bowl Size	O.A. Length	DRBD. Size	14 Ga. 304 S/S 14" Water Level			16 Ga. 304 S/S 12" Water Level			18 Ga. 304 S/S 12" Water Level			Cu. Ft.
			Model #	Price	Approx. Wt. (lbs.)	Model #	Price	Approx. Wt. (lbs.)	Model #	Price	Approx. Wt. (lbs.)	
16" x 20"	54"	18"	94-1-24-18RL	\$6088	97	93-1-24-18RL	\$5294	82	9-1-24-18RL	\$5021	71	29
	66"	24"	94-1-24-24RL	6329	118	93-1-24-24RL	5464	95	9-1-24-24RL	5052	95	33
	90"	36"	94-1-24-36RL	6957	164	93-1-24-36RL	5862	134	9-1-24-36RL	5363	134	48
20" x 20"	58"	18"	94-21-20-18RL	6685	95	93-21-20-18RL	5799	78	9-21-20-18RL	5274	78	26
	70"	24"	94-21-20-24RL	6897	117	93-21-20-24RL	5853	92	9-21-20-24RL	5390	92	34
	94"	36"	94-21-20-36RL	7824	168	93-21-20-36RL	6213	147	9-21-20-36RL	5990	147	50
24" x 24"	74"	24"	94-41-24-24RL	7996	213	93-41-24-24RL	7106	185	9-41-24-24RL	6597	185	48
	98"	36"	94-41-24-36RL	9364	252	93-41-24-36RL	7385	210	9-41-24-36RL	6900	210	64
20" x 28"	58"	18"	94-81-20-18RL	7916	173	93-81-20-18RL	7172	150	9-81-20-18RL	6675	150	46
	70"	24"	94-81-20-24RL	8132	186	93-81-20-24RL	7385	165	9-81-20-24RL	6893	165	55
	94"	36"	94-81-20-36RL	10233	225	93-81-20-36RL	7611	195	9-81-20-36RL	7070	195	73

Weights and Cubes are approximate



94 Series Shown

### ONE COMPARTMENT WITH ONE DRAINBOARD

#### Spec-Line 94 Series

#### Standard 93 Series

#### Super Saver 9 Series

Bowl Size	O.A. Length	DRBD. Size	14 Ga. 304 S/S 14" Water Level			16 Ga. 304 S/S 12" Water Level			18 Ga. 304 S/S 12" Water Level			Cu. Ft.
			Model #	Price	Approx. Wt. (lbs.)	Model #	Price	Approx. Wt. (lbs.)	Model #	Price	Approx. Wt. (lbs.)	
16" x 20"	40"	18"	94-1-24-18RorL	\$5858	93	93-1-24-18RorL	\$5057	84	9-1-24-18RorL	\$4744	65	20
	46"	24"	94-1-24-24RorL	5960	98	93-1-24-24RorL	5119	90	9-1-24-24RorL	4791	73	24
	58"	36"	94-1-24-36RorL	6495	114	93-1-24-36RorL	5657	101	9-1-24-36RorL	5217	78	26
20" x 20"	44"	18"	94-21-20-18RorL	6433	98	93-21-20-18RorL	5604	90	9-21-20-18RorL	5088	71	20
	50"	24"	94-21-20-24RorL	6533	104	93-21-20-24RorL	5647	96	9-21-20-24RorL	5141	77	23
	62"	36"	94-21-20-36RorL	7320	127	93-21-20-36RorL	5810	120	9-21-20-36RorL	5263	91	31
24" x 24"	54"	24"	94-41-24-24RorL	7634	126	93-41-24-24RorL	6792	118	9-41-24-24RorL	6199	92	28
	66"	36"	94-41-24-36RorL	8815	149	93-41-24-36RorL	6944	141	9-41-24-36RorL	6362	110	42
20" x 28"	44"	18"	94-81-20-18RorL	7472	139	93-81-20-18RorL	6846	130	9-81-20-18RorL	6281	107	36
	50"	24"	94-81-20-24RorL	7599	146	93-81-20-24RorL	6977	137	9-81-20-24RorL	6402	113	46
	62"	36"	94-81-20-36RorL	9594	170	93-81-20-36RorL	7111	159	9-81-20-36RorL	6558	133	54

Weights and Cubes are approximate

See pages 37 and 38 for faucets, accessories, and modifications.

# REGALINE

## Deep Drawn Sinks



### TWO COMPARTMENTS WITH TWO DRAINBOARDS

#### Spec-Line 94 Series

#### Standard 93 Series

#### Super Saver 9 Series

14 Ga. 304 S/S 14" Water Level	16 Ga. 304 S/S 12" Water Level	18 Ga. 304 S/S 12" Water Level
-----------------------------------	-----------------------------------	-----------------------------------

Bowl Size	O.A. Length	DRBD. Size	Model #	Price	Approx. Wt. (lbs.)	Model #	Price	Approx. Wt. (lbs.)	Model #	Price	Approx. Wt. (lbs.)	Cu. Ft.
16" x 20"	72"	18"	94-2-36-18RL	\$8191	141	93-2-36-18RL	\$6952	118	9-2-36-18RL	\$6340	100	40
	85"	24"	94-2-36-24RL	8384	156	93-2-36-24RL	7079	130	9-2-36-24RL	6443	110	46
	109"	36"	94-2-36-36RL	9272	212	93-2-36-36RL	8000	169	9-2-36-36RL	7202	144	58
20" x 20"	81"	18"	94-22-40-18RL	9238	176	93-22-40-18RL	7858	147	9-22-40-18RL	7022	125	44
	93"	24"	94-22-40-24RL	9390	220	93-22-40-24RL	7947	184	9-22-40-24RL	7081	162	50
	117"	36"	94-22-40-36RL	10271	273	93-22-40-36RL	8433	237	9-22-40-36RL	7474	215	72
24" x 24"	101"	24"	94-42-48-24RL	11369	339	93-42-48-24RL	10060	295	9-42-48-24RL	9116	259	65
	125"	36"	94-42-48-36RL	12207	391	93-42-48-36RL	10417	339	9-42-48-36RL	10218	314	96
20" x 28"	81"	18"	94-82-40-18RL	10807	251	93-82-40-18RL	10499	219	9-82-40-18RL	9965	194	64
	93"	24"	94-82-40-24RL	11291	294	93-82-40-24RL	10727	253	9-82-40-24RL	10186	228	73
	117"	36"	94-82-40-36RL	12053	333	93-82-40-36RL	10940	287	9-82-40-36RL	10372	261	96

Weights and Cubes are approximate



### TWO COMPARTMENTS WITH ONE DRAINBOARD

#### Spec-Line 94 Series

#### Standard 93 Series

#### Super Saver 9 Series

14 Ga. 304 S/S 14" Water Level	16 Ga. 304 S/S 12" Water Level	18 Ga. 304 S/S 12" Water Level
-----------------------------------	-----------------------------------	-----------------------------------

Bowl Size	O.A. Length	DRBD. Size	Model #	Price	Approx. Wt. (lbs.)	Model #	Price	Approx. Wt. (lbs.)	Model #	Price	Approx. Wt. (lbs.)	Cu. Ft.
16" x 20"	59"	18"	94-2-36-18RorL	\$7916	108	93-2-36-18RorL	\$6694	88	9-2-36-18RorL	\$6137	72	26
	65"	24"	94-2-36-24RorL	8055	115	93-2-36-24RorL	6795	96	9-2-36-24RorL	6206	80	34
	77"	36"	94-2-36-36RorL	8469	158	93-2-36-36RorL	6918	132	9-2-36-36RorL	6298	115	42
20" x 20"	67"	18"	94-22-40-18RorL	8954	118	93-22-40-18RorL	7623	96	9-22-40-18RorL	6833	83	30
	73"	24"	94-22-40-24RorL	9058	136	93-22-40-24RorL	7661	114	9-22-40-24RorL	6863	95	39
	85"	36"	94-22-40-36RorL	9552	163	93-22-40-36RorL	7786	140	9-22-40-36RorL	6956	123	46
24" x 24"	81"	24"	94-42-48-24RorL	10901	229	93-42-48-24RorL	9647	194	9-42-48-24RorL	8805	172	53
	93"	36"	94-42-48-36RorL	11564	261	93-42-48-36RorL	10383	235	9-42-48-36RorL	9898	194	60
20" x 28"	67"	18"	94-82-40-18RorL	10729	213	93-82-40-18RorL	10275	183	9-82-40-18RorL	9652	167	60
	73"	24"	94-82-40-24RorL	10856	227	93-82-40-24RorL	10402	195	9-82-40-24RorL	9776	176	64
	85"	36"	94-82-40-36RorL	11452	266	93-82-40-36RorL	10740	227	9-82-40-36RorL	9856	207	76

Weights and Cubes are approximate

See pages 37 and 38 for faucets, accessories, and modifications.



# REGALINE

## Deep Drawn Sinks

### THREE COMPARTMENTS WITH TWO DRAINBOARDS

Spec-Line 94 Series

Standard 93 Series

Super Saver 9 Series

14 Ga. 304 S/S 14" Water Level	16 Ga. 304 S/S 12" Water Level	18 Ga. 304 S/S 12" Water Level
-----------------------------------	-----------------------------------	-----------------------------------

Bowl Size	O.A. Length	DRBD. Size	Model #	Price	Approx. Wt. (lbs.)	Model #	Price	Approx. Wt. (lbs.)	Model #	Price	Approx. Wt. (lbs.)	Cu. Ft.
<b>16" x 20"</b>	91"	18"	94-3-54-18RL	<b>\$9711</b>	230	93-3-54-18RL	<b>\$8319</b>	189	9-3-54-18RL	<b>\$6425</b>	182	49
	102"	24"	94-3-54-24RL	<b>9916</b>	248	93-3-54-24RL	<b>8444</b>	197	9-3-54-24RL	<b>6533</b>	190	55
	127"	36"	94-3-54-36RL	<b>10873</b>	275	93-3-54-36RL	<b>8962</b>	239	9-3-54-36RL	<b>8444</b>	208	96
<b>20" x 20"</b>	103"	18"	94-23-60-18RL	<b>11441</b>	248	93-23-60-18RL	<b>9865</b>	203	9-23-60-18RL	<b>8848</b>	198	59
	115"	24"	94-23-60-24RL	<b>11776</b>	276	93-23-60-24RL	<b>10121</b>	220	9-23-60-24RL	<b>9065</b>	195	65
	139"	36"	94-23-60-36RL	<b>12701</b>	408	93-23-60-36RL	<b>10487</b>	387	9-23-60-36RL	<b>9356</b>	364	89
<b>24" x 24"</b>	*127"	24"	94-43-72-24RL	<b>14051</b>	390	93-43-72-24RL	<b>12662</b>	331	9-43-72-24RL	<b>11483</b>	318	98
	*151"	36"	94-43-72-36RL	<b>15074</b>	448	93-43-72-36RL	<b>12940</b>	393	9-43-72-36RL	<b>12239</b>	345	110
<b>20" x 28"</b>	103"	18"	94-83-60-18RL	<b>14219</b>	358	93-83-60-18RL	<b>12719</b>	315	9-83-60-18RL	<b>12115</b>	277	83
	115"	24"	94-83-60-24RL	<b>14424</b>	394	93-83-60-24RL	<b>12936</b>	346	9-83-60-24RL	<b>12323</b>	305	95
	139"	36"	94-83-60-36RL	<b>15506</b>	451	93-83-60-36RL	<b>13245</b>	398	9-83-60-36RL	<b>12535</b>	350	109

\* Requires Two Faucets

Weights and Cubes are approximate



### THREE COMPARTMENTS WITH ONE DRAINBOARD

Spec-Line 94 Series

Standard 93 Series

Super Saver 9 Series

14 Ga. 304 S/S 14" Water Level	16 Ga. 304 S/S 12" Water Level	18 Ga. 304 S/S 12" Water Level
-----------------------------------	-----------------------------------	-----------------------------------

Bowl Size	O.A. Length	DRBD. Size	Model #	Price	Approx. Wt. (lbs.)	Model #	Price	Approx. Wt. (lbs.)	Model #	Price	Approx. Wt. (lbs.)	Cu. Ft.
<b>16" x 20"</b>	78"	18"	94-3-54-18RorL	<b>\$9480</b>	214	93-3-54-18RorL	<b>\$8097</b>	173	9-3-54-18RorL	<b>\$6210</b>	167	42
	83"	24"	94-3-54-24RorL	<b>9579</b>	222	93-3-54-24RorL	<b>8159</b>	188	9-3-54-24RorL	<b>6270</b>	177	45
	95"	36"	94-3-54-36RorL	<b>10124</b>	243	93-3-54-36RorL	<b>8701</b>	220	9-3-54-36RorL	<b>7850</b>	190	51
<b>20" x 20"</b>	89"	18"	94-23-60-18RorL	<b>11183</b>	234	93-23-60-18RorL	<b>9602</b>	207	9-23-60-18RorL	<b>8635</b>	184	52
	95"	24"	94-23-60-24RorL	<b>11258</b>	245	93-23-60-24RorL	<b>9644</b>	205	9-23-60-24RorL	<b>8663</b>	193	55
	107"	36"	94-23-60-36RorL	<b>11893</b>	252	93-23-60-36RorL	<b>9959</b>	216	9-23-60-36RorL	<b>8764</b>	208	60
<b>24" x 24"</b>	*107"	24"	94-43-72-24RorL	<b>13695</b>	342	93-43-72-24RorL	<b>12292</b>	312	9-43-72-24RorL	<b>11233</b>	298	68
	*119"	36"	94-43-72-36RorL	<b>14802</b>	365	93-43-72-36RorL	<b>12396</b>	339	9-43-72-36RorL	<b>11921</b>	320	96
<b>20" x 28"</b>	89"	18"	94-83-60-18RorL	<b>13817</b>	281	93-83-60-18RorL	<b>12404</b>	232	9-83-60-18RorL	<b>11857</b>	225	79
	95"	24"	94-83-60-24RorL	<b>13939</b>	296	93-83-60-24RorL	<b>12528</b>	273	9-83-60-24RorL	<b>11974</b>	268	86
	107"	36"	94-83-60-36RorL	<b>14423</b>	308	93-83-60-36RorL	<b>12644</b>	287	9-83-60-36RorL	<b>12048</b>	277	89

\* Requires Two Faucets

Weights and Cubes are approximate

See pages 37 and 38 for faucets, accessories, and modifications.

# REGALINE

## Deep Drawn Sinks



### FOUR COMPARTMENTS WITH TWO DRAINBOARDS

Spec-Line 94 Series

Standard 93 Series

Super Saver 9 Series

14 Ga. 304 S/S 14" Water Level	16 Ga. 304 S/S 12" Water Level	18 Ga. 304 S/S 12" Water Level
-----------------------------------	-----------------------------------	-----------------------------------

Bowl Size	O.A. Length	DRBD. Size	Model #	Price	Approx. Wt. (lbs.)	Model #	Price	Approx. Wt. (lbs.)	Model #	Price	Approx. Wt. (lbs.)	Cu. Ft.
16" x 20"	110"	18"	94-4-72-18RL	\$12160	210	93-4-72-18RL	\$10479	183	9-4-72-18RL	\$9721	175	58
	122"	24"	94-4-72-24RL	12386	275	93-4-72-24RL	10638	252	9-4-72-24RL	9852	241	64
	146"	36"	94-4-72-36RL	13292	313	93-4-72-36RL	10962	287	9-4-72-36RL	10433	274	86
20" x 20"	126"	18"	94-24-80-18RL	14186	293	93-24-80-18RL	12207	268	9-24-80-18RL	10962	259	87
	138"	24"	94-24-80-24RL	14329	312	93-24-80-24RL	12365	286	9-24-80-24RL	11060	275	95
	162"	36"	94-24-80-36RL	15358	351	93-24-80-36RL	12706	322	9-24-80-36RL	11633	308	111
24" x 24"	154"	24"	94-44-96-24RL	16931	395	93-44-96-24RL	15946	361	9-44-96-24RL	14121	348	106
	178"	36"	94-44-96-36RL	18147	431	93-44-96-36RL	16311	398	9-44-96-36RL	15353	382	122
20" x 28"	126"	18"	94-84-80-18RL	17208	382	93-84-80-18RL	16290	361	9-84-80-18RL	15379	350	97
	138"	24"	94-84-80-24RL	17428	402	93-84-80-24RL	16508	374	9-84-80-24RL	15595	361	106
	162"	36"	94-84-80-36RL	18724	442	93-84-80-36RL	16830	411	9-84-80-36RL	15778	395	124

ALL UNITS REQUIRE TWO FAUCETS

Weights and Cubes are approximate



### FOUR COMPARTMENTS WITH ONE DRAINBOARD

Spec-Line 94 Series

Standard 93 Series

Super Saver 9 Series

14 Ga. 304 S/S 14" Water Level	16 Ga. 304 S/S 12" Water Level	18 Ga. 304 S/S 12" Water Level
-----------------------------------	-----------------------------------	-----------------------------------

Bowl Size	O.A. Length	DRBD. Size	Model #	Price	Approx. Wt. (lbs.)	Model #	Price	Approx. Wt. (lbs.)	Model #	Price	Approx. Wt. (lbs.)	Cu. Ft.
16" x 20"	96"	18"	94-4-72-18RorL	\$11724	202	93-4-72-18RorL	\$10064	165	9-4-72-18RorL	\$9357	158	52
	102"	24"	94-4-72-24RorL	11829	216	93-4-72-24RorL	10131	186	9-4-72-24RorL	9400	175	54
	114"	36"	94-4-72-36RorL	12668	260	93-4-72-36RorL	10449	238	9-4-72-36RorL	9995	227	60
20" x 20"	112"	18"	94-24-80-18RorL	13845	299	93-24-80-18RorL	11965	241	9-24-80-18RorL	9951	229	61
	118"	24"	94-24-80-24RorL	13921	320	93-24-80-24RorL	12005	250	9-24-80-24RorL	10807	239	82
	130"	36"	94-24-80-36RorL	14745	341	93-24-80-36RorL	12168	267	9-24-80-36RorL	10939	250	90
24" x 24"	134"	24"	94-44-96-24RorL	16466	354	93-44-96-24RorL	15601	336	9-44-96-24RorL	13818	327	92
	146"	36"	94-44-96-36RorL	17026	376	93-44-96-36RorL	15793	355	9-44-96-36RorL	14887	344	100
20" x 28"	112"	18"	94-84-80-18RorL	16809	348	93-84-80-18RorL	15972	329	9-84-80-18RorL	15074	317	87
	118"	24"	94-84-80-24RorL	16933	364	93-84-80-24RorL	16092	337	9-84-80-24RorL	15202	329	91
	130"	36"	94-84-80-36RorL	18014	382	93-84-80-36RorL	16219	355	9-84-80-36RorL	15266	347	100

ALL UNITS REQUIRE TWO FAUCETS

Weights and Cubes are approximate

See pages 37 and 38 for faucets, accessories, and modifications.



# SPECIALTY SINKS

## Specialty Sinks

### Corner Sinks

16 Gauge, 304 Stainless Steel

- Adjustable Cross-Bracing
- Stainless Steel Legs
- Stainless Steel Adjustable Bullet Feet



94-K3-11D Shown

MINI CORNER

OPTIONAL:

5/8" Thick Poly-Vance Cutting Boards Available  
(See Grid For Proper Model)

### Six Deep Drawn Combinations To Choose From!

Model #	Bowl Sizes	Wall Dim.	Drbd. Dim.	Price	Approx. Wt.	Approx. Cubes	Optional Poly-Vance Cutting Boards
94-K6-18D	1) 20" x 20" x 12" 2) 16" x 20" x 12"	61" x 61"	18"	<b>\$11156</b>	231 lbs.	71	K-2E <b>\$434</b>
94-K2-24D	3) 20" x 20" x 12"	71" x 71"	24"	<b>11450</b>	265 lbs.	99	K-2E <b>434</b>
94-K4-24D	3) 24" x 24" x 12"	79" x 79"	24"	<b>12212</b>	338 lbs.	114	K-2F <b>434</b>
94-K8-30D	1) 20" x 20" x 12" 2) 20" x 28" x 12"	86" x 86"	30"	<b>13001</b>	350 lbs.	131	K-2E <b>434</b>
94-K3-11D	1) 14" x 14" x 12" 2) 14" x 16" x 12"	54" x 54"	17"	<b>7645</b>	215 lbs.	60	K-2H <b>434</b>
94-K5-11D	1) 14" x 14" x 10" 2) 10" x 14" x 10"	42" x 42"	11"	<b>8282</b>	180 lbs.	37	K-2H <b>434</b>

## FABRICATED SPECIALTY SINKS

### Convenience Store Sinks

Our Solution....to Your Limited Space Problem  
In Six Feet or less... you can WASH, RINSE & SANITIZE

- 18 Gauge Stainless Steel
- Stainless Steel Legs
- Welded Cross Bracing
- Stainless Steel Adjustable Bullet Feet

All Sinks Feature  
TWO Drainboards



Model #	Bowl Size	# of Comp.	Drbd. Size	O.A. Length	Price	Approx. Wt.	Approx. Cu.
K7-CS-21	10" x 14" x 10"	3	12"	58"	<b>\$4086</b>	85 lbs.	27
K7-CS-22	10" x 14" x 10"	3	18"	70"	<b>4200</b>	120 lbs.	39
K7-CS-29	14" x 16" x 12"	3	12"	70"	<b>4474</b>	138 lbs.	39
K7-CS-32	12" x 20" x 12"	3	12"	64"	<b>5193</b>	130 lbs.	35

### Super Size Sinks 16 Gauge, 304 Stainless Steel

Model #	Bowl Size	# of Comp.	Drbd. Size	Overall Size L x W	Price	Approx. Wt.	Approx. Cu.
K7-3-1432-18RL*	14" x 32" x 12"	3	18"	78" x 36"	<b>\$10877</b>	290 lbs.	50
K7-3-2030-24RL	20" x 30" x 14"	3	24"	108" x 36"	<b>15574</b>	345 lbs.	78
K7-3-2430-24RL	24" x 30" x 14"	3	24"	120" x 36"	<b>16191</b>	380 lbs.	86
K7-3-3024-24RL	30" x 24" x 14"	3	24"	138" x 30"	<b>16759</b>	395 lbs.	84
K7-3-3030-24RL	30" x 30" x 14"	3	24"	138" x 36"	<b>17553</b>	420 lbs.	98

\*12" Deep Bowls For 14 Gauge Units Add -14 At End Of Model Number & Add \$778 List.



- Fabricated Design
- 16 ga. 304 Series
- 14" Deep Bowls
- Tile Edge Splash
- Full Skirt Design
- Stainless Steel Legs
- Stainless Steel Adjustable Bullet Feet
- Space Saving - Reduced Overall Lengths

### Meat & Platter Sink

16 Gauge, 304 Stainless Steel

- Two 18" Drainboards
- 91" x 35 1/2"

Bowl Sizes:

- 1 - 24" x 30" Bowl
- 2 - 15" x 32" Bowls

• 351 lbs. 59 Cu. Ft.



18-K5-56 \$16444

### Heavy Duty Extra Long Faucet

Required Faucet For Meat & Platter Sink



- Splash Mount
- 18" Swing Spout
- 8" O.C.
- T&S Equivalent: 5f-8WLX18

K-211 \$823

Units Can Be Customized With Modifications & Accessories!  
See Pages 37 & 38. Other Sizes Available. Call For Pricing.

# FABRICATED

## FC Series Fabricated Sinks



**SUPER STURDY**  
CROSS BRACING

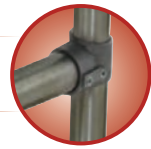

### 16 GAUGE FABRICATED SINKS

- 16 Ga. 304 Stainless Steel
- 14" Deep Bowls
- All Welded Super-Sturdy Cross-Bracing
- 8-1/2" Backsplash with Tile Edge
- Stainless Steel Legs
- Adjustable Stainless Steel Bullet Feet

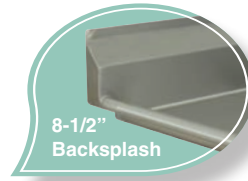

#### ONE COMPARTMENT SINKS

Bowl Size	Model #	O.A. Length	O.A. Width	Price	Wt.	Cu.
16" x 20"	FC-1-1620	21"	26"	\$1681	49	12
	FC-1-1620-18RorL	36.5"	26"	2057	65	18
	FC-1-1620-18RL	52"	26"	2268	80	25
18" x 18"	FC-1-1818	23"	24"	1710	50	13
	FC-1-1818-18RorL	38.5"	24"	2097	60	22
	FC-1-1818-18RL	54"	24"	2294	72	24
	FC-1-1818-24RorL	45"	24"	2124	66	17
18" x 24"	FC-1-1818-24RL	66"	24"	2295	85	26
	FC-1-1824	23"	30"	1830	63	16
	FC-1-1824-18RorL	38.5"	30"	2294	130	25
	FC-1-1824-24RorL	45"	30"	2465	139	28
24" x 24"	FC-1-1824-18RL	54"	30"	2605	170	34
	FC-1-1824-24RL	66"	30"	2709	175	40
	FC-1-2424	29"	30"	2200	68	16
	FC-1-2424-18RorL	44.5"	30"	3338	95	28
30" x 24"	FC-1-2424-24RorL	50.5"	30"	3524	146	34
	FC-1-2424-18RL	60"	30"	3543	175	37
	FC-1-2424-24RL	72"	30"	3679	196	44
	FC-1-3024	35"	30"	4838	80	20
36" x 24"	FC-1-3024-24RorL	56.5"	30"	5241	180	41
	FC-1-3024-24RL	78"	30"	5735	225	50
	FC-1-3624	41"	30"	5735	200	26
48" x 24"	FC-1-3624-24RorL	62.5"	30"	5980	225	46
	FC-1-3624-24RL	84"	30"	8182	250	59
	FC-1-4824-24RL	96"	30"	8616	290	56

#### TWO COMPARTMENT SINKS

Bowl Size	Model #	O.A. Length	O.A. Width	Price	Wt.	Cu.
15" x 15"	FC-2-1515	35"	21"	\$2916	57	19
	FC-2-1620	37"	26"	2916	60	18
16" x 20"	FC-2-1620-18RorL	52.5"	26"	3104	62	25
	FC-2-1620-18RL	68"	26"	3506	101	32
18" x 18"	FC-2-1818	41"	24"	2647	66	23
	FC-2-1818-18RorL	56.5"	24"	3074	89	26
	FC-2-1818-18RL	72"	24"	3506	183	41
	FC-2-1818-24RL	84"	24"	3542	200	30
18" x 24"	FC-2-1824	41"	30"	3227	181	26
	FC-2-1824-18RorL	56.5"	30"	3671	185	37
	FC-2-1824-24RorL	62.5"	30"	3671	200	39
	FC-2-1824-18RL	72"	30"	3716	210	44
20" x 30"	FC-2-1824-24RL	84"	30"	4160	230	51
	FC-2-2030-18RorL	60.5"	36"	7452	195	42
	FC-2-2030-18RL	76"	36"	7607	250	47
	FC-2-2030-24RorL	66.5"	36"	7806	250	45
24" x 24"	FC-2-2030-24RL	88"	36"	7984	285	56
	FC-2-2424	53"	30"	4037	181	33
	FC-2-2424-18RorL	68.5"	30"	4671	233	42
	FC-2-2424-24RorL	74.5"	30"	4785	240	46
	FC-2-2424-18RL	84"	30"	4931	245	53
	FC-2-2424-24RL	96"	30"	4931	255	60

Additional Sizes Available.

See Modifications & Accessories on Pages 37 & 38

#### Fabricated Corner Sink

16 Gauge, 304 Stainless Steel

FC-K6-18D \$4876



- Welded Cross-Bracing
- S/S Legs & Bullet Feet
- Requires 2 Faucets (Not Included)
- 3 - 18" x 18" x 14" Bowls
- 2 - 18" x 18" Drainboards
- Wall Dimension: 57" x 57"
- 248 Lbs. 66 Cu. Ft.



**SUPER STURDY**  
CROSS BRACING



# FABRICATED

## FC Series Fabricated Sinks

### 16 GAUGE FABRICATED SINKS

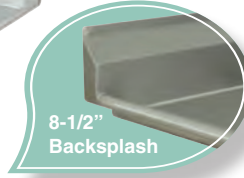

- 16 Ga. 304 Stainless Steel
- 14" Deep Bowls
- All Welded Super-Sturdy Cross-Bracing
- 8-1/2" Backsplash with Tile Edge Splash
- Stainless Steel Legs
- Adjustable Stainless Steel Bullet Feet

### THREE COMPARTMENT SINKS

Bowl Size	Model #	O.A. Length	O.A. Width	Price	Wt.	Cu.
15" x 15"	FC-3-1515	50"	21"	\$3554	85	25
	FC-3-1515-15RorL	62.5"	21"	2850	98	31
	FC-3-1515-15RL	75"	21"	4659	120	42
15" x 24"	FC-3-1524	50"	30"	5045	180	34
	FC-3-1524-24RorL	71.5"	30"	5174	210	58
	FC-3-1524-24RL	93"	30"	5433	255	52
16" x 20"	FC-3-1620	53"	26"	3554	120	25
	FC-3-1620-18RorL	68.5"	26"	3750	225	32
	FC-3-1620-18RL	84"	26"	3870	235	38
	FC-3-1620-24RL	96"	26"	4080	263	49
18" x 18"	FC-3-1818	59"	24"	3668	135	25
	FC-3-1818-18RorL	74.5"	24"	3750	235	31
	FC-3-1818-24RorL	80.5"	24"	3785	250	34
	FC-3-1818-18RL	90"	24"	3870	245	47
18" x 24"	FC-3-1818-24RL	102"	24"	4080	265	53
	FC-3-1824	59"	30"	4244	182	36
	FC-3-1824-18RorL	74.5"	30"	4646	220	61
	FC-3-1824-24RorL	80.5"	30"	5193	230	49
18" x 24"	FC-3-1824-18RL	90"	30"	4811	265	56
	FC-3-1824-24RL	102"	30"	5317	270	63
	†FC-3-2424	79"	30"	4640	243	47
	†FC-3-2424-18RorL	92.5"	30"	5460	260	56
24" x 24"	†FC-3-2424-24RorL	98.5"	30"	5628	281	67
	†FC-3-2424-18RL	108"	30"	5826	295	64
	†FC-3-2424-24RL	120"	30"	5945	315	68
20" x 28"	FC-3-2028-24RL	108"	34"	5416	310	62
20" x 30"	FC-3-2030-20RL	100"	36"	5865	318	58
	FC-3-2030-24RL	108"	36"	7609	330	64
	FC-3-2030-30RL	120"	36"	8087	345	70
24" x 30"	†FC-3-2430	77"	36"	5562	225	38
	†FC-3-2430-24RL	120"	36"	9595	345	81
	†FC-3-2430-30RorL	105"	36"	8492	335	62
	†FC-3-2430-36RL	144"	36"	10016	410	93

† Requires Two Sets of Faucets

Bowl Size	Model #	O.A. Length	O.A. Width	Price	Wt.	Cu.
30" x 24"	†FC-3-3024-24RL	138"	30"	9706	360	81
	†FC-3-3024-30RL	150"	30"	10044	395	86
	†FC-3-3024-36RL	162"	30"	10399	425	93
30" x 30"	†FC-3-3030	95"	36"	8869	250	43
	†FC-3-3030-24RL	138"	36"	12831	390	96
	†FC-3-3030-36RL	162"	36"	15866	460	112

† Requires Two Sets of Faucets



### FOUR COMPARTMENT SINKS

Bowl Size	Model #	O.A. Length	O.A. Width	Price	Wt.	Cu.
18" x 18"	FC-4-1818-18RL†	108"	24"	\$6804	280	51
18" x 24"	FC-4-1824-18RL†	108"	30"	7455	340	62
24" x 24"	FC-4-2424-24RL†	144"	30"	9660	355	80

† Requires Two Sets of Faucets

### Tubular KD Wall Mounted Drainage Shelves

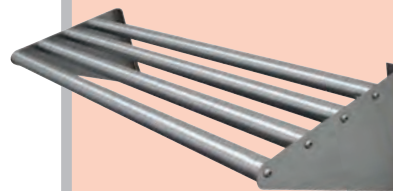

- Stainless Steel
- 15" Deep
- 1-5/8" Diameter Stainless Steel Tubing

Model #	Size	Price
DT-6R-36	3"	\$1519
DT-6R-48	4"	1758
DT-6R-60	5"	1974
DT-6R-72	6"	2163

# FABRICATED

## Fabricated Sinks

# SPEC-LINE

## 14 GAUGE FABRICATED SINKS

- 14 Ga. 304 Stainless Steel
- 14" Deep Bowls
- 8-1/2" Backsplash with Tile Edge Splash
- Continuous Apron Design
- All Welded Super-Sturdy Cross-Bracing
- Stainless Steel Legs & Adjustable Stainless Steel Bullet Feet

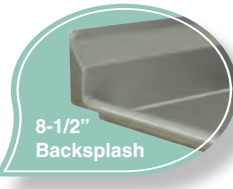

**SUPER STURDY**  
CROSS BRACING



### Features and Benefits

- 3/4" Radius Corners
- Economical Savings
- Satin Finish



### ONE COMPARTMENT SINKS

Bowl Size	Model #	O.A. Length	O.A. Width	Price	Wt.	Cu.
16" x 20"	FS-1-1620	21"	26"	\$3488	60	12
	FS-1-1620-18RorL	36.5"	26"	3749	80	20
	FS-1-1620-18RL	52"	26"	4073	100	27
18" x 18"	FS-1-1818	23"	24"	3557	60	11
	FS-1-1818-18RorL	38.5"	24"	3999	72	17
	FS-1-1818-18RL	54"	24"	4423	75	24
	FS-1-1818-24RorL	45"	24"	4058	66	17
18" x 24"	FS-1-1818-24RL	66"	24"	4531	85	26
	FS-1-1824	23"	30"	3867	78	16
	FS-1-1824-18RorL	38.5"	30"	4427	92	25
	FS-1-1824-24RorL	44.5"	30"	4644	105	28
24" x 24"	FS-1-1824-18RL	54"	30"	4753	175	34
	FS-1-1824-24RL	66"	30"	4961	198	40
	FS-1-2424	29"	30"	4446	90	19
	FS-1-2424-18RorL	44.5"	30"	4999	110	28
	FS-1-2424-24RorL	50.5"	30"	5057	119	34
30" x 24"	FS-1-2424-18RL	60"	30"	5161	185	37
	FS-1-2424-24RL	72"	30"	6224	209	44
	FS-1-3024	35"	30"	5111	115	23
	FS-1-3024-24RorL	56.5"	30"	5997	190	35
	FS-1-3024-24RL	78"	30"	6445	240	47
36" x 24"	FS-1-3624	41"	30"	5779	140	26
	FS-1-3624-24RorL	62.5"	30"	6669	210	39
	FS-1-3624-24RL	84"	30"	8669	260	51
48" x 24"	FS-1-4824-24RL	96"	30"	9091	315	59

### TWO COMPARTMENT SINKS

Bowl Size	Model #	O.A. Length	O.A. Width	Price	Wt.	Cu.
15" x 15"	FS-2-1515	35"	21"	\$4967	57	19
	FS-2-1620	37"	26"	5014	100	20
16" x 20"	FS-2-1620-18RorL	52.5"	26"	5446	120	27
	FS-2-1620-18RL	68"	26"	5581	143	34
18" x 18"	FS-2-1818	41"	24"	5111	98	18
	FS-2-1818-18RorL	56.5"	24"	5500	110	26
	FS-2-1818-18RL	72"	24"	5779	125	30
	FS-2-1818-24RL	84"	24"	5801	200	30
18" x 24"	FS-2-1824	41"	30"	5379	149	26
	FS-2-1824-18RorL	56.5"	30"	5931	169	35
	FS-2-1824-24RorL	62.5"	30"	6597	190	39
	FS-2-1824-18RL	72"	30"	6780	220	44
24" x 24"	FS-2-1824-24RL	84"	30"	7849	240	51
	FS-2-2424	53"	30"	5923	179	33
	FS-2-2424-18RorL	68.5"	30"	7254	200	42
	FS-2-2424-24RorL	74.5"	30"	7431	220	48
	FS-2-2424-18RL	84"	30"	7821	245	53
30" x 24"	FS-2-2424-24RL	96"	30"	8381	270	60
	FS-2-3024	65"	30"	7334	265	40
	FS-2-3024-24RorL	86.5"	30"	8669	300	52
FS-2-3024-24RL	108"	30"	9113	320	64	

### Popular 8" O.C. Sink Faucets



8" Swing Spout  
K-1118 \$662



12" Swing Spout  
K-112 \$708



14" Swing Spout  
K-105 \$613

Additional Sizes Available.

See Modifications & Accessories on Pages 37 & 38

**SUPER STURDY**  
CROSS BRACING

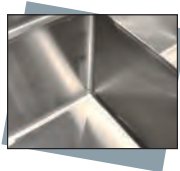

Fabricated Bowls are Welded Together at the Seams & Polished

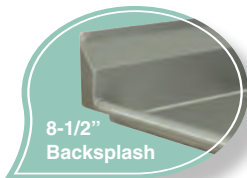

8-1/2" Backsplash



# FABRICATED

## Fabricated Sinks

# SPEC-LINE

## 14 GAUGE FABRICATED SINKS

- 14 Ga. 304 Stainless Steel
- 14" Deep Bowls
- 8-1/2" Backsplash with Tile Edge Splash
- Continuous Apron Design
- All Welded Super-Sturdy
- Cross-Bracing
- Stainless Steel Legs & Adjustable
- Stainless Steel Bullet Feet

### THREE COMPARTMENT SINKS

Bowl Size	Model #	O.A. Length	O.A. Width	Price	Wt.	Cu.
15" x 15"	FS-3-1515	50"	21"	<b>\$7014</b>	85	25
	FS-3-1515-15RorL	62.5"	21"	<b>7261</b>	98	31
	FS-3-1515-15RL	75"	21"	<b>7613</b>	120	42
15" x 24"	FS-3-1524	50"	30"	<b>7854</b>	180	34
	FS-3-1524-24RorL	71.5"	30"	<b>8190</b>	210	58
	FS-3-1524-24RL	93"	30"	<b>8610</b>	255	52
16" x 20"	FS-3-1620	53"	26"	<b>7041</b>	140	27
	FS-3-1620-18RorL	68.5"	26"	<b>7835</b>	160	35
	FS-3-1620-18RL	84"	26"	<b>8601</b>	155	36
	FS-3-1620-24RL	96"	26"	<b>9249</b>	235	47
18" x 18"	FS-3-1818	59"	24"	<b>7334</b>	130	25
	FS-3-1818-18RorL	75"	24"	<b>8003</b>	150	31
	FS-3-1818-18RL	90"	24"	<b>8892</b>	170	52
	FS-3-1824	59"	30"	<b>7601</b>	158	36
18" x 24"	FS-3-1824-18RorL	74.5"	30"	<b>8538</b>	174	46
	FS-3-1824-24RorL	80.5"	30"	<b>8801</b>	187	49
	FS-3-1824-18RL	90"	30"	<b>9760</b>	310	54
20" x 28"	FS-3-1824-24RL	102"	30"	<b>10444</b>	375	61
	FS-3-2028-24RL	108"	34"	<b>10857</b>	310	62
20" x 30"	FS-3-2030-20RL	100"	36"	<b>10763</b>	318	58
	FS-3-2030-24RL	108"	36"	<b>11760</b>	330	64
24" x 24"	FS-3-2030-30RL	120"	36"	<b>12023</b>	345	70
	FS-3-2424†	77"	30"	<b>8556</b>	329	47
	FS-3-2424-18RorL†	92.5"	30"	<b>9543</b>	353	56
	FS-3-2424-24RorL†	98.5"	30"	<b>9779</b>	369	59
24" x 30"	FS-3-2424-18RL†	108"	30"	<b>10779</b>	382	64
	FS-3-2424-24RL†	120"	30"	<b>10968</b>	405	71
	FS-3-2430-24RL†	120"	36"	<b>11547</b>	345	81
30" x 24"	FS-3-2430-30RL†	132"	36"	<b>11676</b>	370	86
	FS-3-2430-36RL†	144"	36"	<b>11886</b>	410	93
	FS-3-3024-24RL†	138"	30"	<b>12023</b>	360	81
30" X 30"	FS-3-3024-30RL†	150"	30"	<b>12259</b>	395	86
	FS-3-3024-36RL†	162"	30"	<b>12315</b>	425	93
	FS-3-3030-24RL†	138"	36"	<b>15008</b>	390	96
	FS-3-3030-36RL†	162"	36"	<b>17039</b>	460	112

† Requires Two Sets of Faucets

### FOUR COMPARTMENT SINKS

Bowl Size	Model #	O.A. Length	O.A. Width	Price	Wt.	Cu.
24" x 24"	FS-4-2424-24RL†	144"	30"	<b>\$12449</b>	355	80
20" x 28"	FS-4-2028-24RL†	128"	34"	<b>13633</b>	280	51

### FC & FS Series Accessories

Optional Front Cross Bracing For FS Sinks  
FC-CB-1 \$60 per foot



Stainless Steel Leg With Bullet Foot  
K-475 \$105 per leg

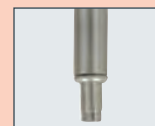

Stainless Steel Sink Covers



See Page 37

Removable 12" Side Splashes For FC & FS Series Sinks  
Accommodates Left & right Sides



Model #	Price	Description
K-700	<b>\$670</b>	For FC & FS Series Sink Bowls: 10"x14", 14"x16", 15"x15", 16"x20"
K-700F-18	<b>704</b>	FC & FS Sink Bowls: 18"x18" Sink Bowls
K-700F-24	<b>739</b>	For FC & FS Series Sink Bowls: 15"x24", 18"x24", 24"x24" & 30"x24"
K-700F-30	<b>817</b>	For FC & FS Series Sink Bowls: 20"x30", 24"x30", 30"x30"

See Page 38 for Additional Faucets

# BUDGET SINKS

## Budget Line Scullery Sinks

 = Ship Via UPS

For Residential Finish & Packaging, Add K-350 \$480



4-1-24 Shown

- 18" & 21" Wide Sink Bowls Are 14" Deep
- 24" Wide Sink Bowls Are 13" Deep
- 3-1/2" Basket Drain
- 8" O.C. Faucet Holes On Splash

	Bowl Size	L	Wt.	Cu. Ft.	"400" Series (430 S/S)		"600" Series (300 S/S)	
					Model #	Price	Model #	Price
1 COMP.	18" x 18"	18"	44 lbs.	8	4-81-18	\$1586	6-81-18	\$1821
	21" x 18"	18"	47 lbs.	9	4-1-18	1614	N/A	-
	21" x 24"	24"	53 lbs.	12	4-1-24	1642	6-1-24	2057
	21" x 36"	36"	66 lbs.	16	4-1-36	1878	6-1-36	2115
	24" x 24"	24"	54 lbs.	12	4-41-24	1994	6-41-24	2204
2 COMP.	24" x 36"	36"	69 lbs.	17	4-41-36	2134	6-41-36	2352
	21" x 36"	36"	73 lbs.	16	4-2-36	2321	6-2-36	2615
	21" x 48"	48"	86 lbs.	21	4-2-48	2527	6-2-48	2876
	21" x 60"	60"	98 lbs.	26	4-2-60	3203	N/A	-
	24" x 48"	48"	88 lbs.	22	4-42-48	2792	6-42-48	3084
3 COMP.	24" x 60"	60"	108 lbs.	27	4-42-60	3382	N/A	-
	21" x 36"	36"	78 lbs.	16	4-3-36	2497	6-3-36	2792
	21" x 48"	48"	91 lbs.	21	4-3-48	2707	6-3-48	3203
	21" x 54"	54"	98 lbs.	24	4-3-54	2818	6-3-54	3290

## 3-1/2" Rear Deck Budget Sinks



4-1-24D Shown

- 14" Deep Bowls
- 4" Back Splash
- 3-1/2" Basket Drain
- 8" O.C. Faucet Holes On Deck



4-41-48D Shown

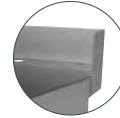

4" Back Splash

Bowl Size	L	Wt.	Cu. Ft.	"400" Series (430 S/S)		"600" Series (300 S/S)	
				Model #	Price	Model #	Price
21" x 18"	18"	47 lbs.	9	4-1-18D	\$1767	N/A	-
21" x 24"	24"	53 lbs.	12	4-1-24D	1815	6-1-24D	2179
24" x 24"	24"	54 lbs.	12	4-41-24D	2124	6-41-24D	2550
24" x 36"	36"	66 lbs.	17	4-41-36D	2221	6-41-36D	2665
24" x 48"	48"	79 lbs.	17	4-41-48D	3072	6-41-48D	3688

## Heavy Duty Deck Mounted Service Faucets

Model #	Spout	Price
K-127	8"	\$662
K-128	12"	708
K-129	14"	739



## Drainboards

Model #	Size	Approx. Wt.	Approx. Cu. Ft.	Price
N-5-818	18" x 18"	13 lbs.	1	\$601
N-5-18	21" x 18"	15 lbs.	1	646
N-5-24	21" x 24"	18 lbs.	1	748
N-5-30	21" x 30"	22 lbs.	2	843
N-5-36	21" x 36"	25 lbs.	2	1350
N-5-48	21" x 48"	28 lbs.	3	1615
N-54-24	24" x 24"	20 lbs.	1	804
N-54-36	24" x 36"	25 lbs.	2	1421
N-54-48	24" x 48"	30 lbs.	3	1682

- Drainboards 36" & Larger Supplied With Legs
- Sides & End Of Drainboard Turned Up with 2" Hemmed Edges Along Top

## Stainless Steel Sink Covers For One Compartment Budget Sinks

Model #	Size	Price
LSC-81	18" x 18"	\$672
LSC-24	21" x 24"	672
LSC-242	24" x 24"	672
LSC-36	24" x 36"	672



Stores Conveniently On Side Of Sink

## MOBILE & SILVER SOAK SINKS



### Mobile Sinks

34" Working Height

A Multi-Purpose Unit.

Move it where the ACTION is! A must for the large food preparation type installation.

Model #	Bowl Size	Price	Approx. Wt.
9-FMS-20	22" x 22" x 8"	\$6175	50 lbs.
9-FMS-12	22" x 22" x 12"	6766	50 lbs.

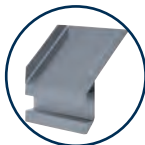

Optional Chute  
9-SS-1 \$712



Optional Bumpers  
9-SS-2 \$335

### Silver Soak Sinks

20" Working Height

UNIVERSAL BOWL SIZE.

Accommodates 19 3/4" x 19 3/4" Dishwasher Baskets

Model #	Bowl Size	Price	Approx. Wt.
9-FSS-20	22" x 22" x 8"	\$5900	42 lbs.



### Silver Soak Sinks with Detachable Chute

20" Working Height

Required for the Scullery operation that promotes clean sanitary flatware.

Model #	Bowl Size	Price	Approx. Wt.
9-FSC-20	22" x 22" x 8"	\$6469	50 lbs.

Shown with  
Optional Bumpers



# SINK MODS

## Sink Modifications & Accessories

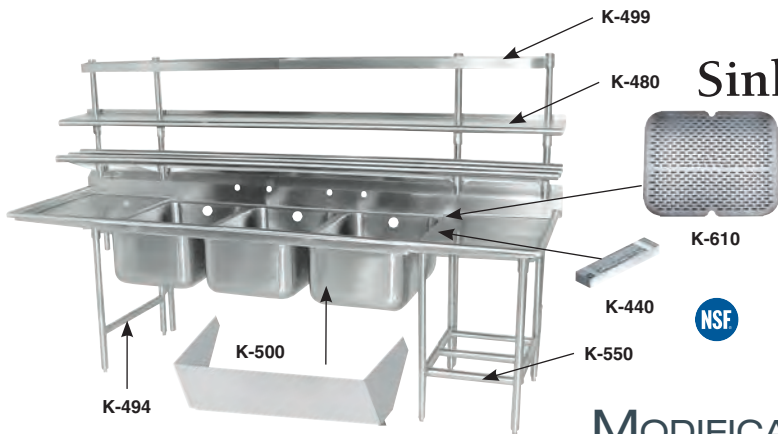

**K-37**  
Anti-Siphon Vacuum Breaker Holes



**K-72**  
Leg-To-Wall Brace



**K-460A**  
Disposal Cone w/ Control Bracket & Faucet Holes



**K-461A**  
Install Collar w/ Control Bracket

### MODIFICATIONS

K-4	Support Bracket for Lever Waste Drain Handle	\$105 ea.
K-23	Sink Legs Welded To Undershelf Or Left-To-Right Cross Rails, Shipped Set Up & Crated. (Top Is Not Welded To Legs)	589 per sink
K-23A	Sink Legs Welded To Leg Gussets Under Sink Top & To Undershelf Or Left-To-Right Cross Rails, Shipped Set Up & Crated	778 per sink
K-24	Shell Crating	455
K-37	Anti-Siphon Vacuum Breaker Holes	176
K-57	Welded field Joint (Welded in field by others)	411 per sink
K-76	Paint on Sound Deadening	783
K-77	Splash Cutout (Pipe Chase)	278
K-106	Mirror Highlite Edge for Sink	638
K-440	Waste Trough with 2" deep removable basket	1341
K-447	High Backsplash up to 18"	278 lin. ft.
K-448	High Backsplash up to 13"	223 lin. ft.
K-450	Extend Drainboard Length (Drainboards over 36" Are Not Creased or Pitched.)	564 lin. ft.
K-451	Drainboard Corner Turn	1970 ea.
K-452	Control Bracket 8" x 12"	392 ea.
K-452S	Splash Mounted Control Bracket 8" x 12"	443 ea.
K-453	Control Bracket 14" x 16"	420 ea.
K-453S	Splash Mounted Control Bracket 14" x 16"	489 ea.
K-454	Sidesplash	610 ea.
K-456	Scrap Block Installed	573
K-460	Installation of Disposal Cone with 8" x 12" Control Bracket, Faucet Holes (Cone supplied by others)	1171 ea.

K-460A	Installation of Disposal Cone with 14" x 16" Control Bracket, Faucet Holes (Cone supplied by others)	\$1243 ea.
K-461	Install Collar with 8" x 12" control bracket (Collar by others)	1171
K-461A	Install Collar with 14" x 16" control bracket (Collar by others)	1243
K-470	Modify Bowl Depth	254 ea.
K-472	Faucet Hole Revision	185 ea.
K-473	Working Height Revision	148 ea.
K-476	Punch for Over Flow Holes (Holes Only. N/C when ordering K-15)	83 ea.
K-479	Undershelf Under Drainboard	354 lin. ft.
K-480	Stainless Steel 12" Wide Shelf (min. of 3 ft.)	368 lin. ft.
K-480A	Stainless Steel 15" Wide Shelf (min. of 3 ft.)	528 lin. ft.
K-490	Provision for Pot Washer (For "Wells-PW-106" only)	1476 ea.
K-491	Provision for Hatco Heater	279 ea.
K-495	Turn Down Backsplash (Includes 2 Brackets. See K-397 Add'l Sets)	245
K-498	Tubular Overshelf 12" wide (Min. 3 Ft.)	554 lin. ft.
K-499	Stainless Steel Pot Rack	440 lin. ft.
K-500	Stainless Steel Apron to Cover Sink Bowls	1382 ea.
K-500A	17" Stainless Steel Apron to Cover Sink Bowls and Support Lever Drain Handles	1607 ea.
K-508	Special Sizing Charge (Larger size cut down to smaller size)	N/C ea.
K-508A	Special Modification Charge	373 ea.
K-510	Prepare Sink for Undercounter Dishwasher (24" drainboard or larger)	208 per sink
K-520	Poly Board/Stainless Steel Cover Holder	988 ea.
K-550	Stainless Steel Tubular Rack Storage	303 lin. ft.
K-ROD	Weld Support Rods For Poly Sink Cover In Corners Of Sink Bowl	708 ea.

### ACCESSORIES

K-30	Faucet Wall Mounting Bracket	\$521 ea.
K-72	Leg To Wall Brace	436
K-350	Residential Finish & Packaging	528 ea.
K-397	Wall Bracket for Sink (Includes 2 Brackets with K-495 Mod.)	125 ea.
K-457	Replacement Rubber Scrap Block (See K-456 for install cost)	174 ea.
K-474	16 ga., '304' Series S/S Leg with S/S Foot	169 ea.
K-475	S/S Leg with S/S Foot	105 ea.
K-477	Replacement Leg Clamp for Adjustable Cross-Bracing	29 ea.
K-477C	Replacement Corner Leg Clamp for Adjustable Cross-Bracing	41 ea.
K-478	Stainless Steel Bullet Foot	42 ea.
K-488	Flanged S/S Bullet Foot	89 ea.
K-493	16 ga., '304' Series S/S Welded Leg Assembly with S/S Feet	559 ea.
K-494	S/S Welded Leg Assembly with S/S Feet	497 ea.
K-497	Galv. Welded Leg Assembly with Plastic Feet	333 ea.
K-497A	Galv. Individual Legs with Plastic Feet	120 set/4
K-496	Leg Assembly For Grease Interceptor w/ Adj. Cross-Bracing & S/S Feet (For Grease Interceptors with 15" Ht. or less. Consult factory for larger Grease Interceptors)	612 ea.
K-610	Perforated Stainless Steel Sink Grid (Specify Bowl Size)	1119 ea.

### SINK COVERS

Choose Model # & Add The Proper Letter In Place Of The Underscore (\_).  
Example: K-2A or FC-455H

Bowl Size	FOR DEEP DRAWN BOWLS		FOR FABRICATED BOWLS	
	Poly Covers Model K-2_ \$434	S/S Covers Model K-455_ \$726	Poly Covers Model K-2_ \$434	S/S Covers Model FC-455_ \$726
10" x 14"	A	A	AF	A
12" x 20"	I	I	IF	I
14" x 14"	H	H	HF	H
14" x 16"	B	B	BF	B
15" x 15"	Not Available	Not Available	MF	M
15" x 24"	Not Available	Not Available	VF	V
16" x 20"	C	C	CF	C
18" x 18"	Not Available	Not Available	JF	J
18" x 24"	D	D	DF	D
20" x 20"	E	E	EF	E
20" x 24"	Not Available	Not Available	PF	P
20" x 28"	G	G	GF	G
20" x 30"	Not Available	Not Available	SF	S
24" x 30"	Not Available	Not Available	TF	T
24" x 24"	F	F	FF	F
24" x 36"	Not Available	Not Available	RF	R
30" x 30"	Not Available	Not Available	UF	U

Custom Covers Available. Consult Factory.

**K-ROD** Welded Support Rods for Poly Sink Covers in Corners of Sink Bowl (Replaces Standard Support Clips) **\$708 per bowl**

### Tubular KD Wall Mounted Drainage Shelves

Model #	Size	Price
DT-6R-36	3"	\$1519
DT-6R-48	4"	1758
DT-6R-60	5"	1974
DT-6R-72	6"	2163

- Stainless Steel
  - 15" Deep
  - 1-5/8" Diameter Stainless Steel Tubing
-

# FAUCETS & DRAINS

All Items On This Page  
Ship Via UPS

## For Sinks & Dishtables

### PRERINSE FAUCETS Wall Bracket Included

**SPEC-LINE  
HEAVY DUTY  
Splash Mounted  
Prerinse Faucet**  
DTA-53 **\$1103**



**Deck Mounted  
Prerinse Faucet**  
K-115 **\$1758**



**Splash Mounted  
Prerinse Faucet**  
K-116 **\$1758**



12" Add-A-Faucet for  
DTA-53 Prerinse  
Faucets  
K-117 **\$272**



12" Add-A-Faucet for  
K-115 & K-116  
Prerinse  
Faucets  
K-117-TS **\$810**



Replacement Hose  
Handle Not Included

K-113 **\$240**



Replacement  
Spray  
Head &  
Handle  
K-114 **\$287**



### HEAVY DUTY FAUCETS

**8" Swing Spout Faucet**  
8" O.C.  
K-1118 **\$662**



**16" Swing Spout Faucet**  
8" O.C.  
K-119 **\$770**



**12" Swing Spout Faucet**  
8" O.C.  
K-112 **\$708**



**18" Swing Spout Faucet**  
8" O.C.  
K-211 **\$823**



**14" Swing Spout Faucet**  
8" O.C.  
K-105 **\$613**



**Faucet Mounting Kit for**  
K-1, K-11, K-101, K-1105, K-119,  
K-119, K-127, K-128, K-129, K-159,  
K-161, K-1118, K-211 & DTA-53  
K-06 **\$105 Set of 2**



**Extra Heavy Duty  
T&S 14" Swing  
Spout Faucet**  
8" O.C.  
K-111 **\$890**



**Wall Mounted  
Service Faucet**  
8" O.C.  
K-240 **\$1046**



*\*K-240 Does Not Meet Federal Lead Free Standards As It Is Not Intended For Potable Water.*

### STANDARD DUTY FAUCETS

Model	Spout Length	Price
K-101	8"	<b>\$332</b>
K-1	12"	<b>371</b>
K-11	14"	<b>423</b>



### WRIST HANDLES

For Standard Duty 8" O.C. Faucets  
Fits K-1, K-11 & K-101  
K-316-LU **\$175 set**



For Heavy Duty 8" O.C. Faucets  
Fits K-105, K-112, K-119, K-127, K-128, K-129, K-134,  
K-159, K-161, K-1118 & K-211  
K-416-LU **\$289 set**



For Extra Heavy Duty 8" O.C. Faucets  
Fits K-69, K-111, K-115, K-116 & K-117-TS  
K-416-TS-LU **\$517 set**



### Replacement Cartridges

Set of 2. Includes Handles.

For Faucets:

K-1, K-11,  
K-101 &  
K-160

K-00B

**\$159 (Set of 2)**



### Replacement Cartridges

Fits K-105, K-112, K-119, K-127,  
K-128, K-129, K-159, K-161,  
K-1118 & K-211

K-07 **\$240 (2 Cartridges, 2 Handles)**



### Vacuum Breaker Repair Kit For K-240

K-03 **\$168**



### Faucet Wall Mounting Bracket

K-30  
**\$465**

For use when no backsplash is  
available to mount faucet



### Heavy Duty Replacement Spouts

Model	Spout Size/Style	Price
K-1118SP	8" Swing Spout	<b>\$216</b>
K-1125SP	12" Swing Spout	<b>231</b>
K-105SP	14" Swing Spout	<b>257</b>
K-119SP	16" Swing Spout	<b>269</b>
K-211SP	18" Swing Spout	<b>284</b>
Standard Duty Replacement Spouts		
K-101SP	8" Swing Spout	<b>101</b>
K-1SP	12" Swing Spout	<b>122</b>
K-11SP	14" Swing Spout	<b>131</b>

### Continuous Waste For 3 Compartment Sink



K-351  
**\$520**

1-1/2" Dia.  
For Use with 2 & 3  
Compartment Sinks

### Chrome Plated P-Trap

**Heavy Gauge  
(17 Gauge)  
7-PS-10 \$196**

**Standard Gauge  
(22 Gauge)  
7-PS-14 \$174**



### Twist Handle Operated Drain



K-5 **\$231**

Twist Drain  
Support Bracket  
K-4 **\$105**

### Twist Handle Operated Drain with Overflow

K-15 **\$336**



### Replacement Drains



Assembly  
K-6 **\$67**



Basket  
K-310 **\$42**

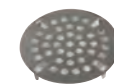

Strainer Plate for 3-1/2" Drain  
K-410 **\$36**

### SPEC-LINE Twist Handle Operated Drain

K-40 **\$1337**

All  
Stainless Steel



### Replacement "O" Rings for Twist Handle Operated Drains

For K-5 & K-15 Drains

K-05  
**\$29**

Washer for  
Twist Handle

Stopper  
Washer

**WARNING:** Equipment that includes a faucet may expose you to chemicals, including lead, that are known to the State of California to cause cancer or birth defects or other reproductive harm. For more info., visit [www.p65warnings.ca.gov](http://www.p65warnings.ca.gov).

\*K-240 Service Faucet Does Not Meet Federal Lead Free Standards As It Is Not Intended For Potable Water.



# FLOOR TROUGHS

## Floor Troughs & Floor Drains

**Consult Factory For Additional Sizes**  
**Custom Sizes Available - Call For Pricing.**

**Ship Via UPS**

- 14 Gauge 304 Stainless Steel
- Stainless Steel Or Fiberglass Grating
- Pitched Towards Waste
- Subway Grating Constructed From 3/16" X 1" Bars

- Grating Is Spaced 9/16" (Inside Clearance) Between Bars To Prevent Casters From Getting Trapped
- Includes 4" Od. - 3" Long Plumbing Sleeve
- Includes Stainless Steel Strainer Basket With Handle

Size W x L x D	With S/S Grate	Price	Approx. Weight	With Fiberglass Grate	Price	Approx. Weight
12" x 24" x 4"	FTG-1224	\$3445	46 lbs.	FFTG-1224	\$3545	34 lbs.
12" x 30" x 4"	FTG-1230	3546	56 lbs.	FFTG-1230	3646	37 lbs.
12" x 36" x 4"	FTG-1236	3752	66 lbs.	FFTG-1236	3852	40 lbs.
12" x 42" x 4"	FTG-1242	3900	76 lbs.	FFTG-1242	4000	43 lbs.
12" x 48" x 4"	FTG-1248	4200	86 lbs.	FFTG-1248	4300	46 lbs.
12" x 54" x 4"	FTG-1254	4600	96 lbs.	FFTG-1254	4700	49 lbs.
12" x 60" x 4"	FTG-1260	5200	106 lbs.	FFTG-1260	5300	52 lbs.
12" x 72" x 4"	FTG-1272	6239	116 lbs.	FFTG-1272	6339	55 lbs.
12" x 84" x 4"	FTG-1284	7326	126 lbs.	FFTG-1284	7426	81 lbs.
12" x 96" x 4"	FTG-1296*	7542	146 lbs.	FFTG-1296*	7642	90 lbs.
12" x 108" x 4"	FTG-12108*	8189	166 lbs.	FFTG-12108*	8289	99 lbs.
12" x 120" x 4"	FTG-12120*	9917	180 lbs.	FFTG-12120*	10017	108 lbs.
18" x 24" x 4"	FTG-1824	3895	62 lbs.	FFTG-1824	3995	43 lbs.
18" x 30" x 4"	FTG-1830	4091	74 lbs.	FFTG-1830	4191	47 lbs.
18" x 36" x 4"	FTG-1836	4100	86 lbs.	FFTG-1836	4200	54 lbs.
18" x 42" x 4"	FTG-1842	4300	98 lbs.	FFTG-1842	4400	61 lbs.
18" x 48" x 4"	FTG-1848	4400	110 lbs.	FFTG-1848	4500	69 lbs.
18" x 54" x 4"	FTG-1854	5100	122 lbs.	FFTG-1854	5200	76 lbs.
18" x 60" x 4"	FTG-1860	5500	134 lbs.	FFTG-1860	5600	83 lbs.
18" x 72" x 4"	FTG-1872	6925	146 lbs.	FFTG-1872	7025	90 lbs.
18" x 84" x 4"	FTG-1884	8406	165 lbs.	FFTG-1884	8506	111 lbs.
18" x 96" x 4"	FTG-1896*	8621	187 lbs.	FFTG-1896*	8721	125 lbs.
18" x 108" x 4"	FTG-18108*	9917	208 lbs.	FFTG-18108*	10017	138 lbs.
18" x 120" x 4"	FTG-18120*	11425	229 lbs.	FFTG-18120*	11525	150 lbs.
24" x 24" x 4"	FTG-2424	4536	69 lbs.	FFTG-2424	4636	52 lbs.
24" x 30" x 4"	FTG-2430	4889	81 lbs.	FFTG-2430	4989	59 lbs.
24" x 36" x 4"	FTG-2436	5244	104 lbs.	FFTG-2436	5344	68 lbs.
24" x 42" x 4"	FTG-2442	5868	118 lbs.	FFTG-2442	5968	75 lbs.
24" x 48" x 4"	FTG-2448	6797	131 lbs.	FFTG-2448	6897	83 lbs.
24" x 54" x 4"	FTG-2454	7042	145 lbs.	FFTG-2454	7142	95 lbs.
24" x 60" x 4"	FTG-2460	7990	162 lbs.	FFTG-2460	8090	102 lbs.
24" x 72" x 4"	FTG-2472	8414	195 lbs.	FFTG-2472	8514	119 lbs.
24" x 84" x 4"	FTG-2484	9192	218 lbs.	FFTG-2484	9292	137 lbs.
24" x 96" x 4"	FTG-2496*	10170	243 lbs.	FFTG-2496*	10270	153 lbs.
24" x 108" x 4"	FTG-24108*	11543	274 lbs.	FFTG-24108*	11643	168 lbs.
24" x 120" x 4"	FTG-24120*	12322	310 lbs.	FFTG-24120*	12422	188 lbs.

\*Includes Two Drains

**16 GAUGE ALSO AVAILABLE. PLEASE CALL**



**ANY SIZE AVAILABLE!** Call Factory For Pricing



**12" Wide Custom Length**  
Model # FTG-12CUSTOM

**18" Wide Custom Length**  
Model # FTG-18CUSTOM

**24" Wide Custom Length**  
Model # FTG-24CUSTOM

### 7.5" Wide Floor Troughs (4" Depth)



- 14 Gauge 304 Stainless Steel
- Includes Stainless Steel Subway Grating constructed from 3/16" x 1" bars

With Stainless Steel Grating	Size W x L x D	Price	Approx. Weight
FTG-724	7.5" x 24" x 4"	\$3079	44 lbs.
FTG-730	7.5" x 30" x 4"	3285	44 lbs.
FTG-736	7.5" x 36" x 4"	3482	63 lbs.
FTG-748	7.5" x 48" x 4"	4131	82 lbs.
FTG-760	7.5" x 60" x 2"	4462	101 lbs.
FTG-772	7.5" x 72" x 4"	4784	110 lbs.
FTG-784	7.5" x 84" x 4"	5110	119 lbs.
FTG-796	7.5" x 96" x 4"	5437	138 lbs.
FTG-7108	7.5" x 108" x 4"	5777	157 lbs.
FTG-7120	7.5" x 120" x 4"	6120	170 lbs.

### 12" Wide Floor Water Receptacles (2" Depth)



- 14 Gauge 304 Stainless Steel
- Includes Stainless Steel Subway Grating constructed from 3/16" x 1" bars

With Stainless Steel Grating	Size W x L x D	Price	Approx. Weight
FRG-24	12" x 24" x 2"	\$2980	44 lbs.
FRG-36	12" x 36" x 2"	3215	63 lbs.
FRG-48	12" x 48" x 2"	3350	82 lbs.

### 12" Wide Floor Drain (4" Depth)

- 14 Gauge 304 Stainless Steel
- Includes Strainer Basket

**FD-1 \$753**

Optional Stainless  
Steel Grate



With Stainless Steel Grating	Size W x L x D	Price	Approx. Weight
FDR-1212	12" x 12" x 4"	\$2157	26 lbs.

## FLOOR TROUGH ACCESSORIES & MODIFICATIONS

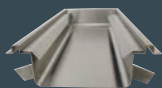

Cut-Out View  
of Anti-Splash

**FT-1 \$158 lin. ft.**  
Optional Anti-Splash Guard  
(Factory Installed)



**FT-2 \$85 ea.**  
Replacement Stainless Steel  
Strainer Basket with Handle

**FT-3 \$173 lin. ft.**  
Modify Trough Depth  
(2" to 6" Deep)

**FT-4 \$360 per hole**  
Modify Drain Outlet Size  
(Allow 2" to 8" Dia)

**FT-5 \$183 lin. ft.**  
Grate Upgrade to A.D.A.

**FT-6 No Charge**  
Modify Length of Trough  
(Select Next Larger Size)



**FT-7 \$80 per lin. ft.**  
No Ledge Floor Trough  
Modification

# TABLES

## Flat Top W/ Undershef

Ship Via UPS

Stainless Steel TOP  
Stainless Steel UNDERSHELF  
Stainless Steel LEGS



VSS Series  
Countertop Edge



SS, MS, SAG Series  
Bull Nose Edge

### Spec-Line

### Premium

### Standard

### Super Saver

14 Ga. 304 S/S

14 Ga. 304 S/S

16 Ga. 304 S/S

16 Ga. 430 S/S

Approx.  
Shipping  
Weight

Approx.  
Cubic  
Feet

	Length	Spec-Line		Premium		Standard		Super Saver		Approx. Shipping Weight	Approx. Cubic Feet
		Model #	Price	Model #	Price	Model #	Price	Model #	Price		
<b>24" WIDE</b>	2'	VSS-242	\$2631	SS-242	\$1758	MS-242	\$1629	SAG-242	\$1581	31 lbs.	3
	30"	VSS-240	2831	SS-240	1950	MS-240	1800	SAG-240	1724	49 lbs.	4
	3'	VSS-243	2928	SS-243	2056	MS-243	1902	SAG-243	1822	64 lbs.	5
	4'	VSS-244	3012	SS-244	2146	MS-244	1974	SAG-244	1871	79 lbs.	6
	5'	VSS-245	3212	SS-245	2336	MS-245	2137	SAG-245	2025	92 lbs.	8
	6'	VSS-246	3406	SS-246	2532	MS-246	2313	SAG-246	2174	109 lbs.	9
	7'	VSS-247	4213	SS-247	3472	MS-247	3183	SAG-247	2680	130 lbs.	11
	8'	VSS-248	4455	SS-248	3719	MS-248	3405	SAG-248	2882	145 lbs.	12
	9'	VSS-249	4607	SS-249	4206	MS-249	4015	SAG-249	4104	161 lbs.	14
	10'	VSS-2410	4906	SS-2410	4503	MS-2410	4115	SAG-2410	4437	261 lbs.	26
	11'	VSS-2411	5326	SS-2411	4827	MS-2411	4392	SAG-2411	4704	293 lbs.	29
	12'	VSS-2412	5434	SS-2412	4932	MS-2412	4499	SAG-2412	4828	308 lbs.	32
<b>30" WIDE</b>	2'	VSS-302	2831	SS-302	1950	MS-302	1800	SAG-302	1724	55 lbs.	4
	30"	VSS-300	2945	SS-300	2070	MS-300	1912	SAG-300	1797	65 lbs.	5
	3'	VSS-303	3047	SS-303	2176	MS-303	2007	SAG-303	1917	72 lbs.	6
	4'	VSS-304	3173	SS-304	2307	MS-304	2113	SAG-304	1994	89 lbs.	8
	5'	VSS-305	3409	SS-305	2536	MS-305	2330	SAG-305	2186	107 lbs.	9
	6'	VSS-306	3779	SS-306	2653	MS-306	2394	SAG-306	2369	126 lbs.	11
	7'	VSS-307	4354	SS-307	3457	MS-307	3165	SAG-307	2784	148 lbs.	13
	8'	VSS-308	4532	SS-308	3825	MS-308	3592	SAG-308	3120	166 lbs.	15
	9'	VSS-309	5051	SS-309	4553	MS-309	4146	SAG-309	4407	176 lbs.	17
	10'	VSS-3010	5347	SS-3010	4848	MS-3010	4439	SAG-3010	4746	287 lbs.	32
	11'	VSS-3011	5735	SS-3011	5247	MS-3011	4785	SAG-3011	5085	324 lbs.	35
	12'	VSS-3012	5842	SS-3012	5355	MS-3012	4896	SAG-3012	5202	339 lbs.	37
<b>36" WIDE</b>	2'	VSS-362	3576	SS-362	2507	MS-362	2352	SAG-362	2164	81 lbs.	7
	3'	VSS-363	3631	SS-363	2560	MS-363	2411	SAG-363	2222	88 lbs.	7
	4'	VSS-364	3704	SS-364	2631	MS-364	2487	SAG-364	2300	98 lbs.	9
	5'	VSS-365	3981	SS-365	2906	MS-365	2735	SAG-365	2552	118 lbs.	11
	6'	VSS-366	4270	SS-366	3169	MS-366	2982	SAG-366	2792	138 lbs.	13
	7'	VSS-367	5213	SS-367	4298	MS-367	4060	SAG-367	3857	164 lbs.	16
	8'	VSS-368	5540	SS-368	4613	MS-368	4346	SAG-368	4164	184 lbs.	18
	9'	VSS-369	5935	SS-369	5418	MS-369	5068	SAG-369	4937	190 lbs.	20
	10'	VSS-3610	6227	SS-3610	5711	MS-3610	5363	SAG-3610	5232	308 lbs.	38
	11'	VSS-3611	6687	SS-3611	6187	MS-3611	5793	SAG-3611	5662	358 lbs.	41
	12'	VSS-3612	6798	SS-3612	6285	MS-3612	5895	SAG-3612	5763	373 lbs.	45
	<b>48" WIDE</b>	4'	VSS-484	6780	SS-484	5264	<b>NOT AVAILABLE</b>				158 lbs.
5'		VSS-485	7336	SS-485	5814	184 lbs.					15
6'		VSS-486	7880	SS-486	6350	218 lbs.					17
7'		VSS-487	10110	SS-487	8592	260 lbs.					20
8'		VSS-488	10800	SS-488	9273	290 lbs.					23
9'		VSS-489	11016	SS-489	9473	322 lbs.					44
10'		VSS-4810	11204	SS-4810	9780	522 lbs.					49
11'		VSS-4811	11391	SS-4811	9968	601 lbs.					54
12'	VSS-4812	11580	SS-4812	10157	616 lbs.	58					

Featuring as Standard: "THE PROVEN"  
Original ADVANCE TABCO Adjustable  
Undershef with Die Cast Leg Clamp

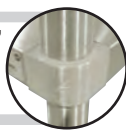

# TABLES

## Flat Top W/ Undershef



VLG Series  
Countertop Edge



GLG, MG, AG Series  
Bull Nose Edge



Stainless Steel TOP  
Galvanized UNDERSHELF  
Galvanized LEGS

### Spec-Line

### Premium

### Standard

### Super Saver

14 Ga. 304 S/S

14 Ga. 304 S/S

16 Ga. 304 S/S

16 Ga. 430 S/S

Approx.  
Shipping  
Weight

Approx.  
Cubic  
Feet

Length	Model #	Price	Model #	Price	Model #	Price	Model #	Price	Approx. Shipping Weight	Approx. Cubic Feet
<b>24" WIDE</b>	2' VLG-242	\$2113	GLG-242	\$1260	MG-242	\$1203	AG-242	\$1122	31 lbs.	3
	30" VLG-240	2260	GLG-240	1392	MG-240	1306	AG-240	1221	49 lbs.	4
	3' VLG-243	2359	GLG-243	1499	MG-243	1409	AG-243	1323	64 lbs.	5
	4' VLG-244	2402	GLG-244	1519	MG-244	1436	AG-244	1350	79 lbs.	6
	5' VLG-245	2536	GLG-245	1664	MG-245	1555	AG-245	1424	92 lbs.	8
	6' VLG-246	2697	GLG-246	1809	MG-246	1683	AG-246	1519	109 lbs.	9
	7' VLG-247	3291	GLG-247	2462	MG-247	2414	AG-247	1941	130 lbs.	11
	8' VLG-248	3479	GLG-248	2647	MG-248	2586	AG-248	2210	145 lbs.	12
	9' VLG-249	3980	GLG-249	3295	MG-249	3091	AG-249	2961	161 lbs.	14
	10' VLG-2410	4321	GLG-2410	3625	MG-2410	3430	AG-2410	3295	261 lbs.	26
	11' VLG-2411	4669	GLG-2411	3867	MG-2411	3625	AG-2411	3306	293 lbs.	29
	12' VLG-2412	4796	GLG-2412	3991	MG-2412	3746	AG-2412	3431	308 lbs.	32
<b>30" WIDE</b>	2' VLG-302	2260	GLG-302	1392	MG-302	1306	AG-302	1221	55 lbs.	4
	30" VLG-300	2317	GLG-300	1442	MG-300	1355	AG-300	1251	65 lbs.	5
	3' VLG-303	2417	GLG-303	1540	MG-303	1455	AG-303	1353	72 lbs.	6
	4' VLG-304	2481	GLG-304	1602	MG-304	1502	AG-304	1379	89 lbs.	8
	5' VLG-305	2661	GLG-305	1766	MG-305	1652	AG-305	1508	107 lbs.	9
	6' VLG-306	2838	GLG-306	1933	MG-306	1809	AG-306	1629	125 lbs.	11
	7' VLG-307	3437	GLG-307	2605	MG-307	2453	AG-307	2041	148 lbs.	13
	8' VLG-308	3676	GLG-308	2842	MG-308	2666	AG-308	2366	166 lbs.	15
	9' VLG-309	4354	GLG-309	3562	MG-309	3338	AG-309	3005	176 lbs.	17
	10' VLG-3010	4687	GLG-3010	3889	MG-3010	3677	AG-3010	3342	287 lbs.	32
	11' VLG-3011	4996	GLG-3011	4268	MG-3011	3924	AG-3011	3549	324 lbs.	35
	12' VLG-3012	5121	GLG-3012	4303	MG-3012	4046	AG-3012	3676	339 lbs.	37
<b>36" WIDE</b>	2' VLG-362	2854	GLG-362	1760	MG-362	1694	AG-362	1509	81 lbs.	7
	3' VLG-363	2911	GLG-363	1811	MG-363	1750	AG-363	1596	88 lbs.	7
	4' VLG-364	2986	GLG-364	1877	MG-364	1824	AG-364	1712	98 lbs.	9
	5' VLG-365	3213	GLG-365	2113	MG-365	2046	AG-365	1932	118 lbs.	11
	6' VLG-366	3430	GLG-366	2298	MG-366	2222	AG-366	2113	138 lbs.	13
	7' VLG-367	4136	GLG-367	3105	MG-367	3027	AG-367	2909	164 lbs.	16
	8' VLG-368	4334	GLG-368	3296	MG-368	3203	AG-368	3091	184 lbs.	18
	9' VLG-369	5170	GLG-369	4299	MG-369	4181	AG-369	3807	190 lbs.	20
	10' VLG-3610	5508	GLG-3610	4642	MG-3610	4515	AG-3610	4127	308 lbs.	38
	11' VLG-3611	5864	GLG-3611	5032	MG-3611	4844	AG-3611	4391	358 lbs.	41
	12' VLG-3612	5991	GLG-3612	5150	MG-3612	4959	AG-3612	4508	373 lbs.	45
	<b>48" WIDE</b>	4' VLG-484	6049	GLG-484	4537	<b>NOT AVAILABLE</b>				158 lbs.
5' VLG-485		6584	GLG-485	5074	184 lbs.					15
6' VLG-486		7017	GLG-486	5080	218 lbs.					17
7' VLG-487		8983	GLG-487	7471	260 lbs.					20
8' VLG-488		9431	GLG-488	7910	290 lbs.					23
9' VLG-489		11063	GLG-489	9452	322 lbs.					44
10' VLG-4810		11283	GLG-4810	9667	522 lbs.					49
11' VLG-4811		11495	GLG-4811	9884	601 lbs.					54
12' VLG-4812	11708	GLG-4812	10092	616 lbs.	58					

# TABLES

## Flat Top W/ Open Base

Stainless Steel TOP  
Stainless Steel LEGS



TVSS Series  
Countertop Edge



TSS, TMS, TSAG Series  
Bullnose Edge

### Spec-Line

### Premium

### Standard

### Super Saver

14 Ga. 304 S/S

14 Ga. 304 S/S

16 Ga. 304 S/S

16 Ga. 430 S/S

Approx.  
Shipping  
Weight

Approx.  
Cubic  
Feet

	Length	Spec-Line		Premium		Standard		Super Saver		Approx. Shipping Weight	Approx. Cubic Feet
		Model #	Price	Model #	Price	Model #	Price	Model #	Price		
<b>24" WIDE</b>	2'	TVSS-242	\$2825	TSS-242	\$1945	TMS-242	\$1821	TSAG-242	\$1766	25 lbs.	3
	30"	TVSS-240	3012	TSS-240	2146	TMS-240	1987	TSAG-240	1913	42 lbs.	4
	3'	TVSS-243	3120	TSS-243	2247	TMS-243	2087	TSAG-243	2012	53 lbs.	5
	4'	TVSS-244	3207	TSS-244	2335	TMS-244	2162	TSAG-244	2062	64 lbs.	6
	5'	TVSS-245	3404	TSS-245	2527	TMS-245	2330	TSAG-245	2204	74 lbs.	8
	6'	TVSS-246	3603	TSS-246	2724	TMS-246	2505	TSAG-246	2360	85 lbs.	9
	7'	TVSS-247	4398	TSS-247	3654	TMS-247	3377	TSAG-247	2871	103 lbs.	11
	8'	TVSS-248	4649	TSS-248	3908	TMS-248	3602	TSAG-248	3070	114 lbs.	12
	9'	TVSS-249	4786	TSS-249	4387	TMS-249	4001	TSAG-249	4299	130 lbs.	14
	10'	TVSS-2410	5084	TSS-2410	4684	TMS-2410	4291	TSAG-2410	4642	227 lbs.	26
	11'	TVSS-2411	5502	TSS-2411	5004	TMS-2411	4575	TSAG-2411	4907	251 lbs.	29
	12'	TVSS-2412	5612	TSS-2412	5110	TMS-2412	4678	TSAG-2412	5025	266 lbs.	32
<b>30" WIDE</b>	2'	TVSS-302	2909	TSS-302	2036	TMS-302	1893	TSAG-302	1831	47 lbs.	4
	30"	TVSS-300	3137	TSS-300	2266	TMS-300	2102	TSAG-300	2002	52 lbs.	5
	3'	TVSS-303	3236	TSS-303	2366	TMS-303	2197	TSAG-303	2112	59 lbs.	6
	4'	TVSS-304	3373	TSS-304	2501	TMS-304	2300	TSAG-304	2189	72 lbs.	8
	5'	TVSS-305	3605	TSS-305	2735	TMS-305	2519	TSAG-305	2375	85 lbs.	9
	6'	TVSS-306	3968	TSS-306	2973	TMS-306	2724	TSAG-306	2560	93 lbs.	11
	7'	TVSS-307	4552	TSS-307	3812	TMS-307	3514	TSAG-307	2975	113 lbs.	13
	8'	TVSS-308	4721	TSS-308	4213	TMS-308	3869	TSAG-308	3306	126 lbs.	15
	9'	TVSS-309	5230	TSS-309	5378	TMS-309	4320	TSAG-309	4612	150 lbs.	17
	10'	TVSS-3010	5520	TSS-3010	5707	TMS-3010	5022	TSAG-3010	4951	261 lbs.	32
	11'	TVSS-3011	5916	TSS-3011	6159	TMS-3011	5420	TSAG-3011	5283	268 lbs.	35
	12'	TVSS-3012	6021	TSS-3012	6281	TMS-3012	5527	TSAG-3012	5400	283 lbs.	37
<b>36" WIDE</b>	2'	TVSS-362	3766	TSS-362	2699	TMS-362	2542	TSAG-362	2352	70 lbs.	7
	3'	TVSS-363	3823	TSS-363	2751	TMS-363	2599	TSAG-363	2414	75 lbs.	7
	4'	TVSS-364	3900	TSS-364	2825	TMS-364	2676	TSAG-364	2497	82 lbs.	9
	5'	TVSS-365	4174	TSS-365	3092	TMS-365	2921	TSAG-365	2739	96 lbs.	11
	6'	TVSS-366	4466	TSS-366	3371	TMS-366	3169	TSAG-366	2982	108 lbs.	13
	7'	TVSS-367	5405	TSS-367	4474	TMS-367	4236	TSAG-367	4054	127 lbs.	16
	8'	TVSS-368	5729	TSS-368	4808	TMS-368	4547	TSAG-368	4345	140 lbs.	18
	9'	TVSS-369	6116	TSS-369	5594	TMS-369	5248	TSAG-369	5613	165 lbs.	20
	10'	TVSS-3610	6403	TSS-3610	5888	TMS-3610	5542	TSAG-3610	5950	261 lbs.	38
	11'	TVSS-3611	6865	TSS-3611	6348	TMS-3611	5966	TSAG-3611	6372	290 lbs.	41
	12'	TVSS-3612	6971	TSS-3612	6466	TMS-3612	6080	TSAG-3612	6490	305 lbs.	45
	<b>48" WIDE</b>	4'	TVSS-484	6971	TSS-484	5447	<b>NOT AVAILABLE</b>				128 lbs.
5'		TVSS-485	7533	TSS-485	6013	148 lbs.					15
6'		TVSS-486	8063	TSS-486	6539	170 lbs.					17
7'		TVSS-487	10306	TSS-487	8782	206 lbs.					20
8'		TVSS-488	10984	TSS-488	9466	228 lbs.					23
9'		TVSS-489	11186	TSS-489	9776	260 lbs.					44
10'		TVSS-4810	11376	TSS-4810	9962	454 lbs.					49
11'		TVSS-4811	11562	TSS-4811	10151	517 lbs.					54
12'	TVSS-4812	11752	TSS-4812	10338	532 lbs.	58					

# TABLES

## Flat Top W/ Open Base



TVLG Series  
Countertop Edge



Stainless Steel TOP  
Galvanized LEGS

### Spec-Line

### Premium

### Standard

### Super Saver

14 Ga. 304 S/S

14 Ga. 304 S/S

16 Ga. 304 S/S

16 Ga. 430 S/S

Approx.  
Shipping  
Weight

Approx.  
Cubic  
Feet

Length	Model #	Price	Model #	Price	Model #	Price	Model #	Price	Approx. Shipping Weight	Approx. Cubic Feet
<b>24" WIDE</b>	2' TVLG-242	\$2300	TGLG-242	\$1445	TMG-242	\$1390	TAG-242	\$1314	25 lbs.	3
	30" TVLG-240	2450	TGLG-240	1583	TMG-240	1502	TAG-240	1409	42 lbs.	4
	3' TVLG-243	2544	TGLG-243	1683	TMG-243	1596	TAG-243	1511	53 lbs.	5
	4' TVLG-244	2590	TGLG-244	1714	TMG-244	1617	TAG-244	1537	64 lbs.	6
	5' TVLG-245	2735	TGLG-245	1855	TMG-245	1743	TAG-245	1614	74 lbs.	8
	6' TVLG-246	2886	TGLG-246	1991	TMG-246	1871	TAG-246	1714	85 lbs.	9
	7' TVLG-247	3483	TGLG-247	2660	TMG-247	2605	TAG-247	2133	103 lbs.	11
	8' TVLG-248	3666	TGLG-248	2833	TMG-248	2778	TAG-248	2407	114 lbs.	12
	9' TVLG-249	4181	TGLG-249	3699	TMG-249	3291	TAG-249	3154	130 lbs.	14
	10' TVLG-2410	4515	TGLG-2410	4039	TMG-2410	3621	TAG-2410	3490	227 lbs.	26
	11' TVLG-2411	4872	TGLG-2411	4073	TMG-2411	3837	TAG-2411	3507	251 lbs.	29
	12' TVLG-2412	4992	TGLG-2412	4190	TMG-2412	3959	TAG-2412	3625	266 lbs.	32
<b>30" WIDE</b>	2' TVLG-302	\$2332	TGLG-302	1467	TMG-302	1394	TAG-302	1325	47 lbs.	4
	30" TVLG-300	2507	TGLG-300	1629	TMG-300	1548	TAG-300	1444	52 lbs.	5
	3' TVLG-303	2606	TGLG-303	1734	TMG-303	1652	TAG-303	1545	59 lbs.	6
	4' TVLG-304	2670	TGLG-304	1799	TMG-304	1688	TAG-304	1571	72 lbs.	8
	5' TVLG-305	2853	TGLG-305	1964	TMG-305	1836	TAG-305	1697	85 lbs.	9
	6' TVLG-306	3037	TGLG-306	2126	TMG-306	1991	TAG-306	1821	93 lbs.	11
	7' TVLG-307	3630	TGLG-307	2792	TMG-307	2633	TAG-307	2227	113 lbs.	13
	8' TVLG-308	3870	TGLG-308	3039	TMG-308	2856	TAG-308	2556	126 lbs.	15
	9' TVLG-309	4557	TGLG-309	3752	TMG-309	3534	TAG-309	3213	150 lbs.	17
	10' TVLG-3010	4888	TGLG-3010	4098	TMG-3010	3869	TAG-3010	3549	261 lbs.	32
	11' TVLG-3011	5202	TGLG-3011	4375	TMG-3011	4125	TAG-3011	3744	268 lbs.	35
	12' TVLG-3012	5327	TGLG-3012	4500	TMG-3012	4245	TAG-3012	3867	283 lbs.	37
<b>36" WIDE</b>	2' TVLG-362	3042	TGLG-362	1939	TMG-362	1877	TAG-362	1760	70 lbs.	7
	3' TVLG-363	3100	TGLG-363	1994	TMG-363	1937	TAG-363	1824	75 lbs.	7
	4' TVLG-364	3173	TGLG-364	2069	TMG-364	2014	TAG-364	1909	82 lbs.	9
	5' TVLG-365	3405	TGLG-365	2300	TMG-365	2235	TAG-365	2124	96 lbs.	11
	6' TVLG-366	3625	TGLG-366	2487	TMG-366	2414	TAG-366	2300	108 lbs.	13
	7' TVLG-367	4330	TGLG-367	3299	TMG-367	3212	TAG-367	3096	127 lbs.	16
	8' TVLG-368	4529	TGLG-368	3485	TMG-368	3387	TAG-368	3242	140 lbs.	18
	9' TVLG-369	5369	TGLG-369	4506	TMG-369	4384	TAG-369	3999	165 lbs.	20
	10' TVLG-3610	5705	TGLG-3610	4842	TMG-3610	4719	TAG-3610	4331	261 lbs.	38
	11' TVLG-3611	6075	TGLG-3611	5236	TMG-3611	5045	TAG-3611	4589	290 lbs.	41
	12' TVLG-3612	6195	TGLG-3612	5357	TMG-3612	5167	TAG-3612	4717	305 lbs.	45
	<b>48" WIDE</b>	4' TVLG-484	6207	TGLG-484	4722	<b>NOT AVAILABLE</b>				128 lbs.
5' TVLG-485		6780	TGLG-485	5264	148 lbs.					15
6' TVLG-486		7348	TGLG-486	5696	170 lbs.					17
7' TVLG-487		9180	TGLG-487	7662	206 lbs.					20
8' TVLG-488		9613	TGLG-488	8094	228 lbs.					23
9' TVLG-489		11261	TGLG-489	9647	260 lbs.					44
10' TVLG-4810		11478	TGLG-4810	9864	454 lbs.					49
11' TVLG-4811		11693	TGLG-4811	10076	517 lbs.					54
12' TVLG-4812	11906	TGLG-4812	10292	532 lbs.	58					

# TABLES

## 1-1/2" Rear Splash W/ Undershef

Stainless Steel TOP  
Stainless Steel UNDERSHELF  
Stainless Steel LEGS

FSS, FMS, SFG Series  
Bullnose Edge



### Premium

### Standard

### Super Saver

14 Ga. 304 S/S

16 Ga. 304 S/S

16 Ga. 430 S/S

Approx. Shipping Weight  
Approx. Cubic Feet

	Length	Model #	Price	Model #	Price	Model #	Price		
<b>24" WIDE</b>	2'	FSS-242	\$1913	FMS-242	\$1781	SFG-242	\$1735	31 lbs.	3
	30"	FSS-240	2112	FMS-240	1943	SFG-240	1873	49 lbs.	4
	3'	FSS-243	2204	FMS-243	2046	SFG-243	1981	64 lbs.	5
	4'	FSS-244	2298	FMS-244	2121	SFG-244	2030	79 lbs.	6
	5'	FSS-245	2497	FMS-245	2287	SFG-245	2174	92 lbs.	8
	6'	FSS-246	2688	FMS-246	2458	SFG-246	2321	109 lbs.	9
	7'	FSS-247	3623	FMS-247	3331	SFG-247	2832	130 lbs.	11
	8'	FSS-248	3869	FMS-248	3549	SFG-248	3039	145 lbs.	12
	9'	FSS-249	4939	FMS-249	4506	SFG-249	4270	161 lbs.	14
	10'	FSS-2410	5282	FMS-2410	4842	SFG-2410	4593	261 lbs.	26
	11'	FSS-2411	5645	FMS-2411	5149	SFG-2411	4863	293 lbs.	29
	12'	FSS-2412	5761	FMS-2412	5270	SFG-2412	4989	308 lbs.	32
<b>30" WIDE</b>	2'	FSS-302	1991	FMS-302	1857	SFG-302	1800	55 lbs.	4
	30"	FSS-300	2222	FMS-300	2062	SFG-300	1976	65 lbs.	5
	3'	FSS-303	2321	FMS-303	2166	SFG-303	2069	72 lbs.	6
	4'	FSS-304	2457	FMS-304	2266	SFG-304	2147	89 lbs.	8
	5'	FSS-305	2697	FMS-305	2476	SFG-305	2335	107 lbs.	9
	6'	FSS-306	2935	FMS-306	2688	SFG-306	2521	125 lbs.	11
	7'	FSS-307	3779	FMS-307	3474	SFG-307	2942	148 lbs.	13
	8'	FSS-308	4167	FMS-308	3837	SFG-308	3268	166 lbs.	15
	9'	FSS-309	5346	FMS-309	4873	SFG-309	4578	176 lbs.	17
	10'	FSS-3010	5671	FMS-3010	5204	SFG-3010	4907	287 lbs.	32
	11'	FSS-3011	6114	FMS-3011	5594	SFG-3011	5244	324 lbs.	35
	12'	FSS-3012	6245	FMS-3012	5716	SFG-3012	5360	339 lbs.	37
<b>36" WIDE</b>	2'	FSS-362	2657	FMS-362	2516	SFG-362	2319	75 lbs.	7
	3'	FSS-363	2712	FMS-363	2565	SFG-363	2378	88 lbs.	7
	4'	FSS-364	2784	FMS-364	2633	SFG-364	2455	98 lbs.	9
	5'	FSS-365	3058	FMS-365	2886	SFG-365	2705	118 lbs.	11
	6'	FSS-366	3322	FMS-366	3137	SFG-366	2945	138 lbs.	13
	7'	FSS-367	4448	FMS-367	4213	SFG-367	4007	164 lbs.	16
	8'	FSS-368	4776	FMS-368	4502	SFG-368	4310	184 lbs.	18
	9'	FSS-369	6317	FMS-369	5916	SFG-369	4704	190 lbs.	20
	10'	FSS-3610	6649	FMS-3610	6252	SFG-3610	4961	223 lbs.	38
	11'	FSS-3611	7181	FMS-3611	6738	SFG-3611	5355	350 lbs.	41
	12'	FSS-3612	7307	FMS-3612	6863	SFG-3612	5660	365 lbs.	45

Units 8 ft. and larger furnished with 6 legs. SPECIAL LENGTHS: Select next largest size. Add **Model # TA-61 No Charge** (ex. SS-306 with TA-61 size to 66" long).



Adjustable Single and Double  
Table Mounted Overshelves  
**See Pages 77.**



For Adjustable Components  
Featuring Potracks & Overshelves  
10", 12" 15" & 18"  
**See Page 84 & 85.**



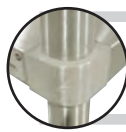

Featuring as Standard: "THE PROVEN"  
Original ADVANCE TABCO Adjustable Undershelf  
with Die Cast Leg Clamp

# TABLES

## 1-1/2" Rear Splash W/ Undershelf



FLG, FMG, FAG Series  
Bullnose Edge

Stainless Steel TOP  
Galvanized UNDERSHELF  
Galvanized LEGS



**Premium**

**Standard**

**Super Saver**

14 Ga. 304 S/S

16 Ga. 304 S/S

16 Ga. 430 S/S

Approx.  
Shipping  
Weight

Approx.  
Cubic  
Feet

	Length	Model #	Price	Model #	Price	Model #	Price		
<b>24" WIDE</b>	2'	FLG-242	\$1409	FMG-242	\$1353	FAG-242	\$1271	31 lbs.	3
	30"	FLG-240	1548	FMG-240	1455	FAG-240	1377	49 lbs.	4
	3'	FLG-243	1652	FMG-243	1560	FAG-243	1469	64 lbs.	5
	4'	FLG-244	1679	FMG-244	1583	FAG-244	1490	79 lbs.	6
	5'	FLG-245	1820	FMG-245	1702	FAG-245	1580	92 lbs.	8
	6'	FLG-246	1950	FMG-246	1831	FAG-246	1679	109 lbs.	9
	7'	FLG-247	2619	FMG-247	2574	FAG-247	2099	130 lbs.	11
	8'	FLG-248	2793	FMG-248	2739	FAG-248	2369	145 lbs.	12
	9'	FLG-249	3462	FMG-249	3255	FAG-249	3115	161 lbs.	14
	10'	FLG-2410	3791	FMG-2410	3589	FAG-2410	3450	261 lbs.	26
	11'	FLG-2411	4035	FMG-2411	3791	FAG-2411	3535	293 lbs.	29
	12'	FLG-2412	4158	FMG-2412	3915	FAG-2412	3591	308 lbs.	32
<b>30" WIDE</b>	2'	FLG-302	1436	FMG-302	1359	FAG-302	1289	55 lbs.	4
	30"	FLG-300	1587	FMG-300	1510	FAG-300	1404	65 lbs.	5
	3'	FLG-303	1693	FMG-303	1608	FAG-303	1508	72 lbs.	6
	4'	FLG-304	1751	FMG-304	1650	FAG-304	1519	89 lbs.	8
	5'	FLG-305	1927	FMG-305	1809	FAG-305	1654	107 lbs.	9
	6'	FLG-306	2087	FMG-306	1950	FAG-306	1781	125 lbs.	11
	7'	FLG-307	2758	FMG-307	2599	FAG-307	2191	148 lbs.	13
	8'	FLG-308	2999	FMG-308	2820	FAG-308	2519	166 lbs.	15
	9'	FLG-309	3719	FMG-309	3491	FAG-309	3165	176 lbs.	17
	10'	FLG-3010	4053	FMG-3010	3837	FAG-3010	3504	287 lbs.	32
	11'	FLG-3011	4335	FMG-3011	4095	FAG-3011	3702	324 lbs.	35
	12'	FLG-3012	4460	FMG-3012	4213	FAG-3012	3836	339 lbs.	37
<b>36" WIDE</b>	2'	FLG-362	1908	FMG-362	1854	FAG-362	1745	75 lbs.	7
	3'	FLG-363	1964	FMG-363	1909	FAG-363	1797	88 lbs.	7
	4'	FLG-364	2037	FMG-364	1983	FAG-364	1866	98 lbs.	9
	5'	FLG-365	2266	FMG-365	2197	FAG-365	2078	118 lbs.	11
	6'	FLG-366	2453	FMG-366	2378	FAG-366	2266	138 lbs.	13
	7'	FLG-367	3263	FMG-367	3169	FAG-367	3059	164 lbs.	16
	8'	FLG-368	3446	FMG-368	3357	FAG-368	3237	184 lbs.	18
	9'	FLG-369	4463	FMG-369	4345	FAG-369	3966	190 lbs.	20
	10'	FLG-3610	4797	FMG-3610	4539	FAG-3610	4299	223 lbs.	38
	11'	FLG-3611	5200	FMG-3611	4999	FAG-3611	4550	350 lbs.	41
	12'	FLG-3612	5322	FMG-3612	5128	FAG-3612	4673	365 lbs.	45

### SIDE SPLASH



TA-30 1 1/2" Side Splash **\$137 ea.**  
TA-31 5" Side Splash **254 ea.**  
TA-32 10 1/2" Side Splash **498 ea.**

### K.D. ALUMINUM PAN RACK SLIDES

6 Slides - 2" Spacing  
Mounted on Tables (min. length 3")

TA-44  
**\$991**



Glass Rack Slides  
3 Slides - 7 1/2" Spacing  
TA-45 **\$905**

### WORKTABLE CASTERS

When Used with Galvanized Legs

TA-25G-4 **\$608/set of 4**  
TA-25G-6 **909/set of 6**

5" Swivels with rubber wheels  
Each set with 2 brakes. Legs  
maintain 35-1/2" working height

TA-25B **\$298** For Brakes on all wheels for  
TA-25SG-4 or TA-25G-6

TA-25C X.H.D. Urethane wheels  
**\$53** each caster

See Page 71 For More Casters

### 3 TIER DRAWERS



Stainless  
Steel

TA-38  
**\$5705**

20" x 20" x 5"  
Drawer Inserts with  
Ball Bearing Slides

### URN TROUGH



TA-64  
**\$240/lin.ft.**

# TABLES

## 1-1/2" Rear Splash W/ Open Base

Stainless Steel TOP  
Stainless Steel LEGS



TFSS, TFMS, TSFG Series  
Bullnose Edge



### Premium

### Standard

### Super Saver

14 Ga. 304 S/S

16 Ga. 304 S/S

16 Ga. 430 S/S

Approx.  
Shipping  
Weight

Approx.  
Cubic  
Feet

Length	Model #	Price	Model #	Price	Model #	Price	Approx. Shipping Weight	Approx. Cubic Feet	
<b>24" WIDE</b>	2'	TFSS-242	\$2102	TFMS-242	\$1976	TSFG-242	\$1950	25 lbs.	3
	30"	TFSS-240	2298	TFMS-240	2137	TSFG-240	2066	42 lbs.	4
	3'	TFSS-243	2402	TFMS-243	2241	TSFG-243	2168	53 lbs.	5
	4'	TFSS-244	2487	TFMS-244	2313	TSFG-244	2208	64 lbs.	6
	5'	TFSS-245	2680	TFMS-245	2476	TSFG-245	2360	74 lbs.	8
	6'	TFSS-246	2880	TFMS-246	2649	TSFG-246	2516	85 lbs.	9
	7'	TFSS-247	3807	TFMS-247	3522	TSFG-247	3027	103 lbs.	11
	8'	TFSS-248	4062	TFMS-248	3749	TSFG-248	3222	114 lbs.	12
	9'	TFSS-249	1374	TFMS-249	4145	TSFG-249	4463	130 lbs.	14
	10'	TFSS-2410	4826	TFMS-2410	4431	TSFG-2410	4797	227 lbs.	26
	11'	TFSS-2411	5142	TFMS-2411	4712	TSFG-2411	5067	251 lbs.	29
	12'	TFSS-2412	5252	TFMS-2412	4820	TSFG-2412	5164	266 lbs.	32
<b>30" WIDE</b>	2'	TFSS-302	2186	TFMS-302	2046	TSFG-302	1987	47 lbs.	4
	30"	TFSS-300	2346	TFMS-300	2251	TSFG-300	2163	52 lbs.	5
	3'	TFSS-303	2516	TFMS-303	2356	TSFG-303	2261	59 lbs.	6
	4'	TFSS-304	2647	TFMS-304	2455	TSFG-304	2336	72 lbs.	8
	5'	TFSS-305	2886	TFMS-305	2666	TSFG-305	2522	85 lbs.	9
	6'	TFSS-306	3123	TFMS-306	2780	TSFG-306	2712	93 lbs.	11
	7'	TFSS-307	3968	TFMS-307	3665	TSFG-307	3128	113 lbs.	13
	8'	TFSS-308	4346	TFMS-308	4017	TSFG-308	3457	126 lbs.	15
	9'	TFSS-309	4876	TFMS-309	4466	TSFG-309	4778	150 lbs.	17
	10'	TFSS-3010	5161	TFMS-3010	4755	TSFG-3010	5109	242 lbs.	32
	11'	TFSS-3011	5562	TFMS-3011	5095	TSFG-3011	5446	268 lbs.	35
	12'	TFSS-3012	5674	TFMS-3012	5207	TSFG-3012	5567	283 lbs.	37
<b>36" WIDE</b>	2'	TFSS-362	2851	TFMS-362	2700	TSFG-362	2526	65 lbs.	7
	3'	TFSS-363	2901	TFMS-363	2753	TSFG-363	2574	70 lbs.	7
	4'	TFSS-364	2975	TFMS-364	2831	TSFG-364	2637	77 lbs.	9
	5'	TFSS-365	3243	TFMS-365	3071	TSFG-365	2889	91 lbs.	11
	6'	TFSS-366	3515	TFMS-366	3322	TSFG-366	3137	103 lbs.	13
	7'	TFSS-367	4642	TFMS-367	4398	TSFG-367	4207	122 lbs.	16
	8'	TFSS-368	4961	TFMS-368	4688	TSFG-368	4500	135 lbs.	18
	9'	TFSS-369	5738	TFMS-369	6113	TSFG-369	5778	160 lbs.	20
	10'	TFSS-3610	6030	TFMS-3610	5681	TSFG-3610	6110	253 lbs.	38
	11'	TFSS-3611	6495	TFMS-3611	6109	TSFG-3611	6532	282 lbs.	41
	12'	TFSS-3612	6606	TFMS-3612	6220	TSFG-3612	6649	297 lbs.	45

Units 8 ft. and larger furnished with 6 legs. SPECIAL LENGTHS: Select next largest size. Add **Model # TA-61 No Charge** (ex. SS-306 with TA-61 size to 66" long).

### SELECTED SPEC-LINE UPGRADES

TA-3	Stainless Steel Hat Channel & Gusset	\$83 /lin. ft.
TA-94	16 ga. S/S 304 Undershelf. (any size)	79 /lin. ft.
TA-95	16 ga. S/S 304 Legs	194 /table
TA-23	Legs Welded to Undershelf or Cross-Rails, Shipped Set Up & Crated.	589 /table
TA-23A	Table Legs Welded To Leg Gussets & Undershelf or Cross-Bracing, Shipped Set Up & Crated.	778 /table

### WORKTABLE CASTERS

Maintains the 35-1/2" Working Height

TA-25S-4	4 Casters for Work Tables (2 w/ Brakes)	\$624 /set of 4
TA-25S-6	6 Casters for Work Tables (2 w/ Brakes)	942 /set of 6
TA-25	4 Casters for Open Base Tables (2 w/ Brakes)	624 /set of 4
TA-25A	6 Casters for Open Base Tables (2 w/ Brakes)	942 /set of 6

See Page 71 for More Caster Options

## 1-1/2" Rear Splash W/ Open Base



TFLG, TFMG, TFAG Series  
Bullnose Edge



Stainless Steel TOP  
Galvanized LEGS

### Premium

### Standard

### Super Saver

14 Ga. 304 S/S

16 Ga. 304 S/S

16 Ga. 430 S/S

Approx.  
Shipping  
Weight

Approx.  
Cubic  
Feet

	Length	Premium		Standard		Super Saver		Approx. Shipping Weight	Approx. Cubic Feet
		Model #	Price	Model #	Price	Model #	Price		
<b>24" WIDE</b>	2'	TFLG-242	\$1933	TFMG-242	\$1545	TFAG-242	\$1457	25 lbs.	3
	30"	TFLG-240	1736	TFMG-240	1650	TFAG-240	1561	42 lbs.	4
	3'	TFLG-243	1836	TFMG-243	1745	TFAG-243	1662	53 lbs.	5
	4'	TFLG-244	1868	TFMG-244	1770	TFAG-244	1688	64 lbs.	6
	5'	TFLG-245	2000	TFMG-245	1893	TFAG-245	1765	74 lbs.	8
	6'	TFLG-246	2146	TFMG-246	2030	TFAG-246	1868	85 lbs.	9
	7'	TFLG-247	2814	TFMG-247	2758	TFAG-247	2286	103 lbs.	11
	8'	TFLG-248	2986	TFMG-248	2928	TFAG-248	2560	114 lbs.	12
	9'	TFLG-249	3654	TFMG-249	3460	TFAG-249	3322	130 lbs.	14
	10'	TFLG-2410	3992	TFMG-2410	3787	TFAG-2410	3662	227 lbs.	26
	11'	TFLG-2411	4228	TFMG-2411	3992	TFAG-2411	3808	251 lbs.	29
	12'	TFLG-2412	4353	TFMG-2412	4108	TFAG-2412	3899	266 lbs.	32
<b>30" WIDE</b>	2'	TFLG-302	1617	TFMG-302	1549	TFAG-302	1481	47 lbs.	4
	30"	TFLG-300	1781	TFMG-300	1699	TFAG-300	1593	52 lbs.	5
	3'	TFLG-303	1877	TFMG-303	1800	TFAG-303	1697	59 lbs.	6
	4'	TFLG-304	1941	TFMG-304	1835	TFAG-304	1714	72 lbs.	8
	5'	TFLG-305	2113	TFMG-305	1991	TFAG-305	1850	85 lbs.	9
	6'	TFLG-306	2283	TFMG-306	2146	TFAG-306	1976	93 lbs.	11
	7'	TFLG-307	2945	TFMG-307	2791	TFAG-307	2379	113 lbs.	13
	8'	TFLG-308	3185	TFMG-308	3009	TFAG-308	2710	126 lbs.	15
	9'	TFLG-309	3915	TFMG-309	3699	TFAG-309	3375	150 lbs.	17
	10'	TFLG-3010	4248	TFMG-3010	4039	TFAG-3010	3702	242 lbs.	32
	11'	TFLG-3011	4539	TFMG-3011	4293	TFAG-3011	3914	268 lbs.	35
	12'	TFLG-3012	4659	TFMG-3012	4409	TFAG-3012	4035	283 lbs.	37
<b>36" WIDE</b>	2'	TFLG-362	2134	TFMG-362	2030	TFAG-362	1930	65 lbs.	7
	3'	TFLG-363	2171	TFMG-363	2090	TFAG-363	1983	70 lbs.	7
	4'	TFLG-364	2222	TFMG-364	2171	TFAG-364	2056	77 lbs.	9
	5'	TFLG-365	2455	TFMG-365	2387	TFAG-365	2276	91 lbs.	11
	6'	TFLG-366	2633	TFMG-366	2574	TFAG-366	2455	103 lbs.	13
	7'	TFLG-367	3451	TFMG-367	3371	TFAG-367	3254	122 lbs.	16
	8'	TFLG-368	3635	TFMG-368	3545	TFAG-368	3431	135 lbs.	18
	9'	TFLG-369	4742	TFMG-369	4547	TFAG-369	4162	160 lbs.	20
	10'	TFLG-3610	4996	TFMG-3610	4876	TFAG-3610	4499	253 lbs.	38
	11'	TFLG-3611	5396	TFMG-3611	5204	TFAG-3611	4753	282 lbs.	41
	12'	TFLG-3612	5513	TFMG-3612	5328	TFAG-3612	4872	297 lbs.	45

## QUICK METRIC CONVERSION TABLE

### CONVERT FROM

Inches  
Meters  
Meters  
Centimeters  
Millimeters  
Cubic Inches

### INTO

Cubic Feet  
Inches  
Feet  
Inches  
Inches  
Gallons

### MULTIPLY BY

L x W x H divided by 1728  
39.37  
3.28  
0.3937  
0.03937  
L x W x H Divided By 231

# TABLES

## 10" & 5" Rear Splash W/ Undershef

Stainless Steel TOP  
Stainless Steel UNDERSHELF  
Stainless Steel LEGS



VKS Series  
10" Back Splash  
Countertop Edge



KSS, KMS, SKG Series  
5" Back Splash  
Bullnose Edge



### Spec-Line

### Premium

### Standard

### Super Saver

14 Ga. 304 S/S

14 Ga. 304 S/S

16 Ga. 304 S/S

16 Ga. 430 S/S

Approx.  
Shipping  
Weight

Approx.  
Cubic  
Feet

	Length	Spec-Line		Premium		Standard		Super Saver		Approx. Shipping Weight	Approx. Cubic Feet
		Model #	Price	Model #	Price	Model #	Price	Model #	Price		
<b>24" WIDE</b>	2'	VKS-242	\$3485	KSS-242	\$2385	KMS-242	\$2254	SKG-242	\$2142	50 lbs.	5
	30"	VKS-240	3691	KSS-240	2589	KMS-240	2433	SKG-240	2402	55 lbs.	6
	3'	VKS-243	3804	KSS-243	2704	KMS-243	2538	SKG-243	2508	66 lbs.	7
	4'	VKS-244	3901	KSS-244	2810	KMS-244	2630	SKG-244	2569	81 lbs.	9
	5'	VKS-245	4100	KSS-245	3026	KMS-245	2822	SKG-245	2720	95 lbs.	12
	6'	VKS-246	4304	KSS-246	3246	KMS-246	3024	SKG-246	2885	113 lbs.	14
	7'	VKS-247	5131	KSS-247	4166	KMS-247	3882	SKG-247	3417	135 lbs.	16
	8'	VKS-248	5393	KSS-248	4435	KMS-248	4131	SKG-248	3624	150 lbs.	18
	9'	VKS-249	5519	KSS-249	4970	KMS-249	5203	SKG-249	4946	165 lbs.	21
	10'	VKS-2410	5834	KSS-2410	5283	KMS-2410	4890	SKG-2410	5287	268 lbs.	28
	11'	VKS-2411	6267	KSS-2411	5650	KMS-2411	5209	SKG-2411	5581	301 lbs.	36
	12'	VKS-2412	6384	KSS-2412	5763	KMS-2412	5321	SKG-2412	5704	316 lbs.	39
<b>30" WIDE</b>	2'	VKS-302	3575	KSS-302	2463	KMS-302	2307	SKG-302	2318	56 lbs.	6
	30"	VKS-300	3816	KSS-300	2727	KMS-300	2544	SKG-300	2506	70 lbs.	7
	3'	VKS-303	3926	KSS-303	2827	KMS-303	2653	SKG-303	2617	77 lbs.	9
	4'	VKS-304	4060	KSS-304	2975	KMS-304	2769	SKG-304	2703	92 lbs.	11
	5'	VKS-305	4307	KSS-305	3238	KMS-305	3020	SKG-305	2891	111 lbs.	14
	6'	VKS-306	4552	KSS-306	3506	KMS-306	3255	SKG-306	3074	129 lbs.	17
	7'	VKS-307	5298	KSS-307	4322	KMS-307	4029	SKG-307	3383	153 lbs.	20
	8'	VKS-308	5702	KSS-308	4753	KMS-308	4424	SKG-308	3871	171 lbs.	22
	9'	VKS-309	5983	KSS-309	5339	KMS-309	4901	SKG-309	5265	289 lbs.	25
	10'	VKS-3010	6294	KSS-3010	5646	KMS-3010	5223	SKG-3010	5615	294 lbs.	40
	11'	VKS-3011	6702	KSS-3011	6084	KMS-3011	5614	SKG-3011	5971	331 lbs.	43
	12'	VKS-3012	6817	KSS-3012	6194	KMS-3012	5725	SKG-3012	6098	346 lbs.	47
<b>36" WIDE</b>	2'	VKS-362	4490	KSS-362	3367	KMS-362	3135	SKG-362	2869	86 lbs.	10
	3'	VKS-363	4545	KSS-363	3422	KMS-363	3189	SKG-363	2932	92 lbs.	10
	4'	VKS-364	4621	KSS-364	3498	KMS-364	3258	SKG-364	3015	101 lbs.	14
	5'	VKS-365	4916	KSS-365	3943	KMS-365	3679	SKG-365	3276	121 lbs.	17
	6'	VKS-366	5217	KSS-366	4235	KMS-366	3940	SKG-366	3540	142 lbs.	20
	7'	VKS-367	6208	KSS-367	5048	KMS-367	4691	SKG-367	4645	169 lbs.	23
	8'	VKS-368	6545	KSS-368	5404	KMS-368	5021	SKG-368	4964	189 lbs.	27
	9'	VKS-369	6895	KSS-369	6362	KMS-369	5858	SKG-369	5310	260 lbs.	30
	10'	VKS-3610	7210	KSS-3610	6668	KMS-3610	6166	SKG-3610	5667	315 lbs.	46
	11'	VKS-3611	7699	KSS-3611	7180	KMS-3611	6628	SKG-3611	6092	358 lbs.	51
	12'	VKS-3612	7815	KSS-3612	7296	KMS-3612	6742	SKG-3612	6231	373 lbs.	55

Units 8 ft. and larger furnished with 6 leg **SPECIAL LENGTHS:** Select next largest size. Add **Model # TA-61 No Charge** (ex. SS-306 with TA-61 size to 66" long).

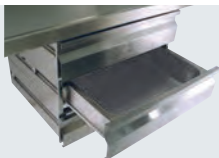

PATENT PENDING



### Revolutionary SHD Series Drawer with Integral Drawer Slides

- Stainless Steel Front & Sides
- Self Closing Drawer with Noise Control
- Drawer "Safety Stop" Tab
- Removable Stainless Steel Insert
- Units can be Stacked to Create Tier Drawers

Model #	Insert Size	Price
SHD-2015	20" x 15" x 5"	\$1591
SHD-1520	15" x 20" x 5"	1591
SHD-2020	20" x 20" x 5"	1699

### DELUXE SERIES

- Stainless Steel Front
- Ball Bearing Slides
- Removable Insert

Stainless Steel		
Model #	Insert Size	Price
SS-2015	20" x 15" x 5"	\$873
SS-1520	15" x 20" x 5"	873
SS-2020	20" x 20" x 5"	944



See Pages 69-70 For More Drawer Details and More Drawer Options!

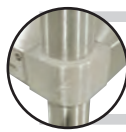

Featuring as Standard: "THE PROVEN"  
Original ADVANCE TABCO Adjustable Undershef  
with Die Cast Leg Clamp



# TABLES

## 10" & 5" Rear Splash W/ Undershef



VKG Series  
10" Back Splash  
Countertop Edge



KLG, KMG, KAG Series  
5" Back Splash  
Bullnose Edge

Spec-Line

Premium

Standard

Stainless Steel TOP  
Galvanized UNDERSHELF  
Galvanized LEGS  
Super Saver

Length	14 Ga. 304 S/S			14 Ga. 304 S/S			16 Ga. 304 S/S			16 Ga. 430 S/S		
	Model #	Price	Model #	Price	Model #	Price	Model #	Price	Approx. Shipping Weight	Approx. Cubic Feet		
<b>24" WIDE</b>	2'	VKG-242	\$2906	KLG-242	\$1677	KMG-242	\$1637	KAG-242	\$1549	50 lbs.	5	
	30"	VKG-240	3059	KLG-240	1821	KMG-240	1766	KAG-240	1654	55 lbs.	6	
	3'	VKG-243	3163	KLG-243	1917	KMG-243	1868	KAG-243	1751	66 lbs.	7	
	4'	VKG-244	3212	KLG-244	1974	KMG-244	1910	KAG-244	1758	81 lbs.	9	
	5'	VKG-245	3373	KLG-245	2113	KMG-245	2046	KAG-245	1877	95 lbs.	12	
	6'	VKG-246	3526	KLG-246	2266	KMG-246	2189	KAG-246	1990	113 lbs.	14	
	7'	VKG-247	4155	KLG-247	2882	KMG-247	2791	KAG-247	2447	135 lbs.	16	
	8'	VKG-248	4354	KLG-248	3071	KMG-248	3007	KAG-248	2724	150 lbs.	18	
	9'	VKG-249	4996	KLG-249	3807	KMG-249	3653	KAG-249	3490	165 lbs.	21	
	10'	VKG-2410	5332	KLG-2410	4127	KMG-2410	3991	KAG-2410	3836	268 lbs.	28	
	11'	VKG-2411	5728	KLG-2411	4286	KMG-2411	4224	KAG-2411	4073	301 lbs.	36	
	12'	VKG-2412	5843	KLG-2412	4460	KMG-2412	4342	KAG-2412	4190	316 lbs.	39	
<b>30" WIDE</b>	2'	VKG-302	2934	KLG-302	1701	KMG-302	1654	KAG-302	1561	56 lbs.	6	
	30"	VKG-300	3108	KLG-300	1871	KMG-300	1821	KAG-300	1688	70 lbs.	7	
	3'	VKG-303	3091	KLG-303	1977	KMG-303	1917	KAG-303	1788	77 lbs.	9	
	4'	VKG-304	3296	KLG-304	2045	KMG-304	1983	KAG-304	1820	92 lbs.	11	
	5'	VKG-305	3488	KLG-305	2220	KMG-305	2146	KAG-305	1945	111 lbs.	14	
	6'	VKG-306	3673	KLG-306	2402	KMG-306	2318	KAG-306	2074	129 lbs.	17	
	7'	VKG-307	4310	KLG-307	3012	KMG-307	2919	KAG-307	2556	153 lbs.	20	
	8'	VKG-308	4584	KLG-308	3269	KMG-308	3159	KAG-308	2889	171 lbs.	22	
	9'	VKG-309	5401	KLG-309	4060	KMG-309	3899	KAG-309	3739	195 lbs.	25	
	10'	VKG-3010	5735	KLG-3010	4391	KMG-3010	4228	KAG-3010	4073	294 lbs.	40	
	11'	VKG-3011	6075	KLG-3011	4702	KMG-3011	4515	KAG-3011	4353	331 lbs.	43	
	12'	VKG-3012	6195	KLG-3012	4826	KMG-3012	4642	KAG-3012	4467	346 lbs.	47	
<b>36" WIDE</b>	2'	VKG-362	3694	KLG-362	2443	KMG-362	2370	KAG-362	2210	86 lbs.	10	
	3'	VKG-363	3755	KLG-363	2497	KMG-363	2411	KAG-363	2287	92 lbs.	10	
	4'	VKG-364	3841	KLG-364	2574	KMG-364	2462	KAG-364	2366	101 lbs.	14	
	5'	VKG-365	4083	KLG-365	2825	KMG-365	2735	KAG-365	2565	121 lbs.	17	
	6'	VKG-366	4309	KLG-366	3027	KMG-366	2920	KAG-366	2716	142 lbs.	20	
	7'	VKG-367	5067	KLG-367	3545	KMG-367	3418	KAG-367	3212	169 lbs.	23	
	8'	VKG-368	5274	KLG-368	3980	KMG-368	3848	KAG-368	3619	189 lbs.	27	
	9'	VKG-369	6272	KLG-369	4908	KMG-369	4717	KAG-369	4560	260 lbs.	30	
	10'	VKG-3610	6601	KLG-3610	5244	KMG-3610	5048	KAG-3610	4900	315 lbs.	46	
	11'	VKG-3611	7007	KLG-3611	5604	KMG-3611	5390	KAG-3611	5213	358 lbs.	51	
	12'	VKG-3612	7124	KLG-3612	5728	KMG-3612	5509	KAG-3612	5333	373 lbs.	55	

### SIDE SPLASH

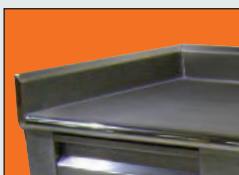

- TA-30 1 1/2" Side Splash **\$137 ea.**
- TA-31 5" Side Splash **254 ea.**
- TA-32 10 1/2" Side Splash **498 ea.**

### K.D. ALUMINUM PAN RACK SLIDES

6 Slides - 2" Spacing  
Mounted on Tables (min. length 3")

TA-44  
**\$991**



Glass Rack Slides  
3 Slides - 7 1/2" Spacing  
TA-45 **\$905**

### WORKTABLE CASTERS

When Used with Galvanized Legs

- TA-25G-4 **\$624/set of 4**
- TA-25G-6 **942/set of 6**

5" Swivels with rubber wheels  
Each set with 2 brakes. Legs maintain 35-1/2" working height

TA-25B **\$298** For Brakes on all wheels for TA-25SG-4 or TA-25G-6

TA-25C X.H.D. Urethane wheels  
**\$53** each caster

See Page 71 For More Casters



### 3 TIER DRAWERS



Stainless Steel

TA-38  
**\$5705**

20" x 20" x 5"  
Drawer Inserts with Ball Bearing Slides

### URN TROUGH

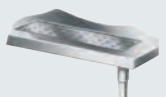

TA-64  
**\$229/lin.ft.**

# TABLES

## 10" & 5" Rear Splash

### W/ Open Base

Stainless Steel TOP  
Stainless Steel LEGS



TVKS Series  
10" Back Splash  
Countertop Edge



TKSS, TKMS, TSKG Series  
5" Back Splash  
Bullnose Edge

TKSS, TKMS,  
TSKG Series  
5" Back Splash  
Bullnose Edge

### Spec-Line

### Premium

### Standard

### Super Saver

14 Ga. 304 S/S	14 Ga. 304 S/S	16 Ga. 304 S/S	16 Ga. 430 S/S
----------------	----------------	----------------	----------------

Approx. Shipping Weight

Approx. Cubic Feet

	Length	Model #	Price	Model #	Price	Model #	Price	Model #	Price	Approx. Shipping Weight	Approx. Cubic Feet
<b>24" WIDE</b>	2'	TVKS-242	\$3514	TKSS-242	\$2457	TKMS-242	\$2336	TSKG-242	\$2336	43 lbs.	5
	30"	TVKS-240	3704	TKSS-240	2661	TKMS-240	2507	TSKG-240	2481	49 lbs.	6
	3'	TVKS-243	3809	TKSS-243	2762	TKMS-243	2606	TSKG-243	2583	55 lbs.	7
	4'	TVKS-244	3902	TKSS-244	2869	TKMS-244	2688	TSKG-244	2630	67 lbs.	9
	5'	TVKS-245	4098	TKSS-245	3070	TKMS-245	2880	TSKG-245	2779	77 lbs.	12
	6'	TVKS-246	4292	TKSS-246	3284	TKMS-246	3068	TSKG-246	2934	89 lbs.	14
	7'	TVKS-247	5079	TKSS-247	4151	TKMS-247	3880	TSKG-247	3437	107 lbs.	16
	8'	TVKS-248	5326	TKSS-248	4413	TKMS-248	4120	TSKG-248	3637	119 lbs.	18
	9'	TVKS-249	5430	TKSS-249	4907	TKMS-249	4532	TSKG-249	4908	135 lbs.	21
	10'	TVKS-2410	5730	TKSS-2410	5207	TKMS-2410	4831	TSKG-2410	5244	234 lbs.	28
	11'	TVKS-2411	6156	TKSS-2411	5557	TKMS-2411	5141	TSKG-2411	5509	258 lbs.	36
	12'	TVKS-2412	6257	TKSS-2412	5664	TKMS-2412	5247	TSKG-2412	5629	273 lbs.	39
<b>30" WIDE</b>	2'	TVKS-302	3602	TKSS-302	2534	TKMS-302	2406	TSKG-302	2406	48 lbs.	6
	30"	TVKS-300	3834	TKSS-300	2780	TKMS-300	2615	TSKG-300	2580	55 lbs.	7
	3'	TVKS-303	3931	TKSS-303	2885	TKMS-303	2716	TSKG-303	2676	62 lbs.	9
	4'	TVKS-304	4061	TKSS-304	3041	TKMS-304	2832	TSKG-304	2758	75 lbs.	11
	5'	TVKS-305	4298	TKSS-305	3279	TKMS-305	3065	TSKG-305	2944	89 lbs.	14
	6'	TVKS-306	4532	TKSS-306	3526	TKMS-306	3291	TSKG-306	3128	97 lbs.	17
	7'	TVKS-307	5240	TKSS-307	4309	TKMS-307	4017	TSKG-307	3545	118 lbs.	20
	8'	TVKS-308	5618	TKSS-308	4713	TKMS-308	4398	TSKG-308	3873	131 lbs.	22
	9'	TVKS-309	5883	TKSS-309	5262	TKMS-309	4854	TSKG-309	5217	150 lbs.	25
	10'	TVKS-3010	6169	TKSS-3010	5557	TKMS-3010	5143	TSKG-3010	5563	249 lbs.	40
	11'	TVKS-3011	6563	TKSS-3011	5972	TKMS-3011	5520	TSKG-3011	5887	276 lbs.	43
	12'	TVKS-3012	6670	TKSS-3012	6082	TKMS-3012	5631	TSKG-3012	6006	291 lbs.	47
<b>36" WIDE</b>	2'	TVKS-362	4466	TKSS-362	3388	TKMS-362	3163	TSKG-362	2925	75 lbs.	10
	3'	TVKS-363	4517	TKSS-363	3446	TKMS-363	3221	TSKG-363	2982	80 lbs.	10
	4'	TVKS-364	4589	TKSS-364	3522	TKMS-364	3296	TSKG-364	3059	85 lbs.	14
	5'	TVKS-365	4870	TKSS-365	3954	TKMS-365	3691	TSKG-365	3306	99 lbs.	17
	6'	TVKS-366	5153	TKSS-366	4226	TKMS-366	3952	TSKG-366	3547	112 lbs.	20
	7'	TVKS-367	6101	TKSS-367	5001	TKMS-367	4662	TSKG-367	4611	131 lbs.	23
	8'	TVKS-368	6425	TKSS-368	5339	TKMS-368	4978	TSKG-368	4920	145 lbs.	27
	9'	TVKS-369	6745	TKSS-369	6230	TKMS-369	6537	TSKG-369	6217	165 lbs.	30
	10'	TVKS-3610	7047	TKSS-3610	6522	TKMS-3610	6051	TSKG-3610	6553	268 lbs.	46
	11'	TVKS-3611	7512	TKSS-3611	7019	TKMS-3611	6493	TSKG-3611	6972	298 lbs.	51
	12'	TVKS-3612	7615	TKSS-3612	7119	TKMS-3612	6600	TSKG-3612	7095	313 lbs.	55

Units 8 ft. and larger furnished with 6 legs. **SPECIAL LENGTHS:** Select next largest size. Add **Model # TA-61 No Charge** (ex. SS-306 with TA-61 size to 66" long).

### SELECTED SPEC-LINE UPGRADES

TA-3	Stainless Steel Hat Channel & Gusset	\$83 /lin. ft.
TA-94	16 ga. S/S 304 Undershelf. (any size)	79 /lin. ft.
TA-95	16 ga. S/S 304 Legs	194 /table
TA-23	Legs Welded to Undershelf or Cross-Rails, Shipped Set Up & Crated.	589 /table
TA-23A	Table Legs Welded To Leg Gussets & Undershelf or Cross-Bracing, Shipped Set Up & Crated.	778 /table

### WORKTABLE CASTERS

Maintains the 35-1/2" Working Height

TA-25S-4	4 Casters for Work Tables (2 w/ Brakes)	\$624 /set of 4
TA-25S-6	6 Casters for Work Tables (2 w/ Brakes)	942 /set of 6
TA-25	4 Casters for Open Base Tables (2 w/ Brakes)	624 /set of 4
TA-25A	6 Casters for Open Base Tables (2 w/ Brakes)	942 /set of 6

See Page 71 for More Caster Options

# TABLES

## 10" & 5" Rear Splash W/ Open Base



TVKG Series  
10" Back Splash  
Countertop Edge



TKLG, TKMG, TKAG Series  
5" Back Splash  
Bullnose Edge



Stainless Steel TOP  
Galvanized LEGS

### Spec-Line

### Premium

### Standard

### Super Saver

14 Ga. 304 S/S

14 Ga. 304 S/S

16 Ga. 304 S/S

16 Ga. 430 S/S

Approx.  
Shipping  
Weight

Approx.  
Cubic  
Feet

Length	Model #	Price	Model #	Price	Model #	Price	Model #	Price	Approx. Shipping Weight	Approx. Cubic Feet	
<b>24" WIDE</b>	2' TVKG-242	\$3092	TKLG-242	\$1866	TKMG-242	\$1822	TKAG-242	\$1740	43 lbs.	5	
	30"	TVKG-240	3254	TKLG-240	2002	TKMG-240	1964	TKAG-240	1850	49 lbs.	6
	3'	TVKG-243	3353	TKLG-243	2112	TKMG-243	2062	TKAG-243	1943	55 lbs.	7
	4'	TVKG-244	3404	TKLG-244	2162	TKMG-244	2099	TKAG-244	1991	67 lbs.	9
	5'	TVKG-245	3549	TKLG-245	2300	TKMG-245	2235	TKAG-245	2070	77 lbs.	12
	6'	TVKG-246	3719	TKLG-246	2455	TKMG-246	2378	TKAG-246	2184	89 lbs.	14
	7'	TVKG-247	4342	TKLG-247	3070	TKMG-247	2976	TKAG-247	2630	107 lbs.	16
	8'	TVKG-248	4552	TKLG-248	3268	TKMG-248	3165	TKAG-248	2919	119 lbs.	18
	9'	TVKG-249	5204	TKLG-249	3999	TKMG-249	3857	TKAG-249	3698	135 lbs.	21
	10'	TVKG-2410	5530	TKLG-2410	4331	TKMG-2410	4190	TKAG-2410	4035	234 lbs.	28
	11'	TVKG-2411	5923	TKLG-2411	4587	TKMG-2411	4430	TKAG-2411	4274	258 lbs.	36
	12'	TVKG-2412	6044	TKLG-2412	4709	TKMG-2412	4549	TKAG-2412	4391	273 lbs.	39
<b>30" WIDE</b>	2' TVKG-302	3122	TKLG-302	1885	TKMG-302	1850	TKAG-302	1750	48 lbs.	6	
	30"	TVKG-300	3300	TKLG-300	2062	TKMG-300	2002	TKAG-300	1873	55 lbs.	7
	3'	TVKG-303	3404	TKLG-303	2166	TKMG-303	2112	TKAG-303	1981	62 lbs.	9
	4'	TVKG-304	3485	TKLG-304	2233	TKMG-304	2171	TKAG-304	2000	75 lbs.	11
	5'	TVKG-305	3673	TKLG-305	2411	TKMG-305	2335	TKAG-305	2141	89 lbs.	14
	6'	TVKG-306	3869	TKLG-306	2590	TKMG-306	2510	TKAG-306	2272	97 lbs.	17
	7'	TVKG-307	4500	TKLG-307	3207	TKMG-307	3103	TKAG-307	2750	118 lbs.	20
	8'	TVKG-308	4776	TKLG-308	3457	TKMG-308	3352	TKAG-308	3081	131 lbs.	22
	9'	TVKG-309	5608	TKLG-309	4257	TKMG-309	4103	TKAG-309	3943	150 lbs.	25
	10'	TVKG-3010	5938	TKLG-3010	4589	TKMG-3010	4435	TKAG-3010	4274	249 lbs.	40
	11'	TVKG-3011	6273	TKLG-3011	4905	TKMG-3011	4719	TKAG-3011	4550	276 lbs.	43
	12'	TVKG-3012	6399	TKLG-3012	5023	TKMG-3012	4842	TKAG-3012	4673	291 lbs.	47
<b>36" WIDE</b>	2' TVKG-362	3911	TKLG-362	2521	TKMG-362	2457	TKAG-362	2427	75 lbs.	10	
	3'	TVKG-363	3954	TKLG-363	2576	TKMG-363	2505	TKAG-363	2482	80 lbs.	10
	4'	TVKG-364	4020	TKLG-364	2649	TKMG-364	2576	TKAG-364	2556	85 lbs.	14
	5'	TVKG-365	4266	TKLG-365	3010	TKMG-365	2921	TKAG-365	2753	99 lbs.	17
	6'	TVKG-366	4499	TKLG-366	3212	TKMG-366	3105	TKAG-366	2909	112 lbs.	20
	7'	TVKG-367	5254	TKLG-367	3739	TKMG-367	3621	TKAG-367	3404	131 lbs.	23
	8'	TVKG-368	5464	TKLG-368	4170	TKMG-368	4033	TKAG-368	3792	145 lbs.	27
	9'	TVKG-369	6467	TKLG-369	5112	TKMG-369	4918	TKAG-369	4767	165 lbs.	30
	10'	TVKG-3610	6800	TKLG-3610	5446	TKMG-3610	5254	TKAG-3610	5093	268 lbs.	46
	11'	TVKG-3611	7203	TKLG-3611	5808	TKMG-3611	5592	TKAG-3611	5420	298 lbs.	51
	12'	TVKG-3612	7321	TKLG-3612	5923	TKMG-3612	5707	TKAG-3612	5531	313 lbs.	55

### Put a Sink in Your Table!



SINGLE & DOUBLE  
BOWLS AVAILABLE

For Integral Sinks  
See Page 68

### POLY-VANCE 5/8" THICK CUTTING BOARDS

Model #	Description	Price
K-2A	Cutting Board For 10"x14" Bowls	\$434 ea.
K-2B	Cutting Board For 14"x16" Bowls	434 ea.
K-2C	Cutting Board For 16"x20" Bowls	434 ea.
K-2D	Cutting Board For 18"x24" Bowls	434 ea.
K-2E	Cutting Board For 20"x20" Bowls	434 ea.
K-2F	Cutting Board For 24"x24" Bowls	434 ea.
K-2J	Cutting Board For 18"x18" Bowls	434 ea.
K-2K	Cutting Board For 30"x24" Bowls	434 ea.

For Faucets & Accessories - See Page 37-38

# TABLES

## Enclosed Base Tables

### FLAT TOP UNITS



**\*Please add "M" after model number when adding Fixed Mid Shelf & refer to prices below**



**14 GAUGE TOP**



#### Open Base

#### Sliding Doors

#### Hinged Doors

	L	Model #	w/ Fixed Mid-Shelf (Add "M")		Model #	# of Doors	w/ Fixed Mid-Shelf (Add "M")		Model #	# of Doors	w/ Fixed Mid-Shelf (Add "M")		Approx. Cubic Feet
<b>24" WIDE</b>	3'	EB-SS-243	\$4182	M \$4993	NOT AVAILABLE			HB-SS-243	2	\$6598	M \$7413	30	
	4'	EB-SS-244	4339	M 5143	CB-SS-244	2	\$5971	M \$6781	HB-SS-244	2	6918	M 7723	38
	5'	EB-SS-245	4646	M 5547	CB-SS-245	2	6417	M 7326	HB-SS-245	2	7373	M 8277	47
	6'	EB-SS-246	4952	M 5971	CB-SS-246	2	6880	M 7901	HB-SS-246	4	7821	M 8839	56
	7'	EB-SS-247	5391	M 6524	CB-SS-247	4	7866	M 9002	HB-SS-247	4	8803	M 9941	66
	8'	EB-SS-248	5667	M 6887	CB-SS-248	4	8498	M 9726	HB-SS-248	4	9447	M 10671	74
	9'	EB-SS-249	6419	M 7845	CB-SS-249	4	9526	M 10953	HB-SS-249	4	10476	M 11904	83
	10'	EB-SS-2410	6713	M 8134	CB-SS-2410	4	9822	M 11239	HB-SS-2410	4	10766	M 12188	92
	12'	EB-SS-2412	9275	M 10407	CB-SS-2412	4	11822	M 13239	HB-SS-2412	6	12766	M 14188	109
<b>30" WIDE</b>	3'	EB-SS-303	4409	M 5333	NOT AVAILABLE			HB-SS-303	2	6828	M 7667	35	
	4'	EB-SS-304	4569	M 5495	CB-SS-304	2	6198	M 7122	HB-SS-304	2	7135	M 8062	45
	5'	EB-SS-305	4909	M 5971	CB-SS-305	2	6686	M 7745	HB-SS-305	2	7642	M 8700	55
	6'	EB-SS-306	5263	M 6437	CB-SS-306	2	7184	M 8362	HB-SS-306	4	8135	M 9310	66
	7'	EB-SS-307	5621	M 6928	CB-SS-307	4	8082	M 9393	HB-SS-307	4	9030	M 10339	76
	8'	EB-SS-308	6207	M 7666	CB-SS-308	4	8849	M 10313	HB-SS-308	4	9795	M 11258	87
	9'	EB-SS-309	6845	M 8548	CB-SS-309	4	9944	M 11653	HB-SS-309	4	10898	M 12613	97
	10'	EB-SS-3010	7134	M 8838	CB-SS-3010	4	10233	M 11942	HB-SS-3010	4	11188	M 12905	107
	12'	EB-SS-3012	9832	M 10961	CB-SS-3012	4	12233	M 13942	HB-SS-3012	6	13188	M 14905	128
<b>36" WIDE</b>	3'	EB-SS-363	4725	M 5752	NOT AVAILABLE			HB-SS-363	2	7319	M 8336	41	
	4'	EB-SS-364	4876	M 5904	CB-SS-364	2	6610	M 7639	HB-SS-364	2	7629	M 8648	53
	5'	EB-SS-365	5246	M 6438	CB-SS-365	2	7139	M 8335	HB-SS-365	2	8159	M 9354	65
	6'	EB-SS-366	5863	M 7217	CB-SS-366	2	7672	M 9022	HB-SS-366	4	8690	M 10040	77
	7'	EB-SS-367	6001	M 7518	CB-SS-367	4	8635	M 10157	HB-SS-367	4	9645	M 11175	90
	8'	EB-SS-368	6630	M 8223	CB-SS-368	4	9461	M 11055	HB-SS-368	4	10463	M 12058	102
	9'	EB-SS-369	7331	M 9325	CB-SS-369	4	10644	M 12643	HB-SS-369	4	11662	M 13651	114
	10'	EB-SS-3610	7625	M 9620	CB-SS-3610	4	10931	M 12933	HB-SS-3610	4	11953	M 13948	126
	12'	EB-SS-3612	10028	M 11803	CB-SS-3612	4	12931	M 14933	HB-SS-3612	6	13953	M 15948	151

## 1-1/2" BACKSPLASH UNITS

#### Open Base

#### Sliding Doors

#### Hinged Doors

	L	Model #	w/ Fixed Mid-Shelf (Add "M")		Model #	# of Doors	w/ Fixed Mid-Shelf (Add "M")		Model #	# of Doors	w/ Fixed Mid-Shelf (Add "M")		Approx. Cubic Feet
<b>24" WIDE</b>	3'	EF-SS-243	\$4182	M \$4993	NOT AVAILABLE			HF-SS-243	2	\$6598	M \$7413	30	
	4'	EF-SS-244	4339	M 5143	CF-SS-244	2	\$5971	M \$6781	HF-SS-244	2	6918	M 7723	38
	5'	EF-SS-245	4646	M 5547	CF-SS-245	2	6417	M 7326	HF-SS-245	2	7373	M 8277	47
	6'	EF-SS-246	4952	M 5971	CF-SS-246	2	6880	M 7901	HF-SS-246	4	7821	M 8839	56
	7'	EF-SS-247	5391	M 6524	CF-SS-247	4	7866	M 9002	HF-SS-247	4	8803	M 9941	66
	8'	EF-SS-248	5667	M 6887	CF-SS-248	4	8498	M 9726	HF-SS-248	4	9447	M 10671	74
	9'	EF-SS-249	6419	M 7845	CF-SS-249	4	9526	M 10953	HF-SS-249	4	10476	M 11904	83
	10'	EF-SS-2410	6713	M 8134	CF-SS-2410	4	9822	M 11239	HF-SS-2410	4	10766	M 12188	92
	12'	EF-SS-2412	9275	M 10407	CF-SS-2412	4	11822	M 13239	HF-SS-2412	6	12766	M 14188	109
<b>30" WIDE</b>	3'	EF-SS-303	4409	M 5333	NOT AVAILABLE			HF-SS-303	2	6828	M 7750	35	
	4'	EF-SS-304	4569	M 5495	CF-SS-304	2	6198	M 7122	HF-SS-304	2	7135	M 8062	45
	5'	EF-SS-305	4909	M 5971	CF-SS-305	2	6686	M 7745	HF-SS-305	2	7642	M 8700	55
	6'	EF-SS-306	5258	M 6437	CF-SS-306	2	7184	M 8362	HF-SS-306	4	8135	M 9310	66
	7'	EF-SS-307	5621	M 6928	CF-SS-307	4	8082	M 9393	HF-SS-307	4	9030	M 10339	76
	8'	EF-SS-308	6207	M 7666	CF-SS-308	4	8849	M 10313	HF-SS-308	4	9795	M 11258	87
	9'	EF-SS-309	6845	M 8548	CF-SS-309	4	9944	M 11653	HF-SS-309	4	10898	M 12602	97
	10'	EF-SS-3010	7134	M 8838	CF-SS-3010	4	10233	M 11942	HF-SS-3010	4	11188	M 12896	107
	12'	EF-SS-3012	9832	M 10961	CF-SS-3012	4	12233	M 13942	HF-SS-3012	6	13188	M 14905	128

FOR 36" WIDE 1-1/2" SPLASH UNITS: Use 36" Flat Top Price and Replace "B" with "F" (Example: EB-SS-364 would change to read EF-SS-364)

\*Please add "M" after model number when adding Fixed Mid Shelf & refer to prices below



# TABLES

## Enclosed Base Tables

### 5" BACKSPLASH UNITS



Open Base



Sliding Doors



Hinged Doors

	L	Model #	w/ Fixed Mid-Shelf (Add "M")		Model #	# of Doors	w/ Fixed Mid-Shelf (Add "M")		Model #	# of Doors	w/ Fixed Mid-Shelf (Add "M")		Approx. Cubic Feet	
24" WIDE	3'	EK-SS-243	\$4314	M \$5043	NOT AVAILABLE				HK-SS-243	2	\$6738	M \$7551	30	
	4'	EK-SS-244	4471	M 5195	CK-SS-244	2	\$6099	M \$6918	HK-SS-244	2	7403	M 8251	38	
	5'	EK-SS-245	4785	M 5606	CK-SS-245	2	6564	M 7474	HK-SS-245	2	7881	M 8849	47	
	6'	EK-SS-246	5106	M 6039	CK-SS-246	2	7040	M 8127	HK-SS-246	4	8380	M 9459	56	
	7'	EK-SS-247	5560	M 6488	CK-SS-247	4	8027	M 9170	HK-SS-247	4	9424	M 10628	66	
	8'	EK-SS-248	5843	M 6973	CK-SS-248	4	8672	M 9896	HK-SS-248	4	10112	M 11396	74	
	9'	EK-SS-249	6627	M 7957	CK-SS-249	4	9729	M 11146	HK-SS-249	4	11207	M 12704	83	
	10'	EK-SS-2410	6921	M 8246	CK-SS-2410	4	10021	M 11442	HK-SS-2410	4	11513	M 13011	92	
	12'	EK-SS-2412	9500	M 10956	CK-SS-2412	4	12021	M 13442	HK-SS-2412	6	12965	M 14391	109	
	30" WIDE	3'	EK-SS-303	4687	M 5467	NOT AVAILABLE				HK-SS-303	2	7305	M 8281	35
		4'	EK-SS-304	4851	M 5623	CK-SS-304	2	6327	M 7249	HK-SS-304	2	7638	M 8611	45
		5'	EK-SS-305	5101	M 6162	CK-SS-305	2	6834	M 7899	HK-SS-305	2	8171	M 9288	55
6'		EK-SS-306	5326	M 6503	CK-SS-306	2	7342	M 8523	HK-SS-306	4	8702	M 9939	66	
7'		EK-SS-307	5782	M 7100	CK-SS-307	4	8251	M 9558	HK-SS-307	4	9666	M 10634	76	
8'		EK-SS-308	6386	M 7844	CK-SS-308	4	9025	M 10486	HK-SS-308	4	11094	M 12710	87	
9'		EK-SS-309	7041	M 8840	CK-SS-309	4	10150	M 11864	HK-SS-309	4	11652	M 13440	97	
10'		EK-SS-3010	7338	M 9030	CK-SS-3010	4	10444	M 12149	HK-SS-3010	4	11956	M 13994	107	
12'		EK-SS-3012	10024	M 11480	CK-SS-3012	4	12444	M 14149	HK-SS-3012	6	13387	M 15328	128	
36" WIDE		3'	EK-SS-363	4863	M 5878	NOT AVAILABLE				HK-SS-363	2	7821	M 8896	41
		4'	EK-SS-364	5017	M 6036	CK-SS-364	2	6749	M 7771	HK-SS-364	2	8153	M 9223	53
		5'	EK-SS-365	5363	M 6671	CK-SS-365	2	7300	M 8486	HK-SS-365	2	8719	M 9970	65
	6'	EK-SS-366	6007	M 7369	CK-SS-366	2	7835	M 9185	HK-SS-366	4	9289	M 10698	77	
	7'	EK-SS-367	6175	M 7688	CK-SS-367	4	8807	M 10334	HK-SS-367	4	10318	M 11909	90	
	8'	EK-SS-368	6813	M 8407	CK-SS-368	4	9639	M 11231	HK-SS-368	4	11848	M 13525	102	
	9'	EK-SS-369	8161	M 9447	CK-SS-369	4	10854	M 12848	HK-SS-369	4	12369	M 14459	114	
	10'	EK-SS-3610	8839	M 9735	CK-SS-3610	4	11055	M 13048	HK-SS-3610	4	12670	M 14760	126	
	12'	EK-SS-3612	10418	M 12343	CK-SS-3612	4	13055	M 15048	HK-SS-3612	6	14067	M 16057	151	

(Approx. shipping weight is 75 lbs. per lineal foot)

FOR 36" WIDE 1-1/2" SPLASH UNITS: Use 36" Flat Top Price and Replace "B" with "F" (Example: EB-SS-364 would change to read EF-SS-364)

**We Recommend a Welded Field Joint For Units Over 12' TA-57 \$377 ea.**  
(Units over 14' require a Welded or Bolted Field Joint)

### ENCLOSED BASE MODIFICATIONS & ACCESSORIES

TA-255P	Four 5" Heavy Duty Bolt-On Casters .....	\$981 set/4
TA-255AP	Six 5" Heavy Duty Bolt-On Casters .....	1428 set/6
TA-20L	Replacement Bolt-on Leg w/ Bullet Foot .....	101 ea.
TA-19L	Replacement Bolt-on Leg w/ Flanged Foot ...	117 ea.
TA-36D	Hinged Door Repair Kit (Includes 1 hinge pin, 1 brass door insert, 1 nylon locking clip. One kit will repair top or bottom hinge) ...	185 ea.
TA-46	Door Lock .....	474 ea.
TA-54	Removable Kick Plate .....	227 /lin. ft.
TA-130	Cutlery Dispenser Holder .....	332 /lin. ft.
TA-135	Plate Shelf .....	396 /lin. ft.



CASH-1 \$1660 ea.  
Undermount Cash Drawer



TA-62A \$648 ea.  
GFI Duplex Outlet

#### TA-116 ADJUSTABLE ENCLOSED BASE CABINET MID SHELF . \$74733 Per Section

Add To Price of Enclosed Base Table with Fixed Mid Shelf (M).  
Shelves Over 36" In Length Require Multiple Sections With Center Partition.  
For Partial Shelves Add to Price of Shelf on Page 71.



For Enclosed Base Tables Over 12' Add:  
TA-65 Open Base Units \$732 /lin. ft.  
TA-66 Sliding Door Units 1066 /lin. ft.  
TA-67 Hinged Door Units 1130 /lin. ft.

TA-36D \$185 ea.  
Hinged Door Repair Kit



# TABLES

## Economy Enclosed Base Tables



### ECONOMY OPEN BASE UNITS

- 16 Gauge, 304 Stainless Steel Top
- 18 Gauge, 430 Stainless Steel Body
- 1-5/8" Rolled Rim On front
- 1-5/8" Square Sides
- Optional Fixed Mid Shelf
- Stainless Steel Legs & Bullet Feet



EEB-SS-244 Shown



EEK-SS-244 Shown

L	FLAT TOP				5" BACK SPLASH				Approx. Cubic Feet
	OPEN BASE	No Shelf List Price	Add "M" for Mid-Shelf	Mid-Shelf List Price	OPEN BASE	No Shelf List Price	Add "M" for Mid-Shelf	Mid-Shelf List Price	
<b>24" WIDE TABLES</b>									
36"	EEB-SS-243	\$4182	M	\$4993	EEK-SS-243	\$4314	M	\$5043	30
48"	EEB-SS-244	4339	M	5143	EEK-SS-244	4471	M	5195	38
60"	EEB-SS-245	4646	M	5547	EEK-SS-245	4785	M	5606	47
72"	EEB-SS-246	4952	M	5971	EEK-SS-246	5106	M	6039	56
84"	EEB-SS-247	5391	M	6524	EEK-SS-247	5560	M	6488	66
96"	EEB-SS-248	5667	M	6887	EEK-SS-248	5843	M	6973	74
108"	EEB-SS-249	6419	M	7845	EEK-SS-249	6627	M	7957	83
120"	EEB-SS-2410	6713	M	8134	EEK-SS-2410	6921	M	8246	92
<b>30" WIDE TABLES</b>									
36"	EEB-SS-303	\$4409	M	\$5333	EEK-SS-303	\$4219	M	\$5467	35
48"	EEB-SS-304	4569	M	5495	EEK-SS-304	4366	M	5623	45
60"	EEB-SS-305	4909	M	5971	EEK-SS-305	4591	M	6162	55
72"	EEB-SS-306	5263	M	6437	EEK-SS-306	4793	M	6503	66
84"	EEB-SS-307	5621	M	6928	EEK-SS-307	5204	M	7100	76
96"	EEB-SS-308	6207	M	7666	EEK-SS-308	5748	M	7844	87
108"	EEB-SS-309	6845	M	8548	EEK-SS-309	6337	M	8840	97
120"	EEB-SS-3010	7134	M	8838	EEK-SS-3010	6605	M	9030	107

### SLIDING & HINGED DOORS

- 16 Gauge, 304 Stainless Steel Top
- 18 Gauge, 430 Stainless Steel Body
- 1-5/8" Rolled Rim On front
- 1-5/8" Square Sides
- Optional Fixed Mid Shelf
- Stainless Steel Legs & Bullet Feet



ECB-SS-244 Shown



EHB-SS-244 Shown

L	FLAT TOP					5" BACK SPLASH					Approx. Cubic Feet						
	SLIDING DOORS	List Price	w/ Fixed Mid-Shelf (Add "M")	HINGED DOORS	List Price	w/ Fixed Mid-Shelf (Add "M")	SLIDING DOORS	List Price	w/ Fixed Mid-Shelf (Add "M")	HINGED DOORS		List Price	w/ Fixed Mid-Shelf (Add "M")				
<b>24" WIDE TABLES</b>																	
36"	N/A			EHB-SS-243	\$6598	M	\$6758	N/A			EHB-SS-243	\$6738	M	\$6900	30		
48"	ECB-SS-244	\$5971	M	\$6116	EHB-SS-244	6918	M	7083	ECK-SS-244	\$6099	M	\$6282	EHB-SS-244	7050	M	7133	38
60"	ECB-SS-245	6417	M	6568	EHB-SS-245	7373	M	7550	ECK-SS-245	6564	M	6722	EHB-SS-245	7506	M	7449	47
72"	ECB-SS-246	6880	M	7048	EHB-SS-246	7821	M	8010	ECK-SS-246	6379	M	7211	EHB-SS-246	7981	M	7970	56
84"	ECB-SS-247	7866	M	8054	EHB-SS-247	8803	M	9013	ECK-SS-247	8027	M	8219	EHB-SS-247	8975	M	8487	66
96"	ECB-SS-248	8498	M	8701	EHB-SS-248	9447	M	9672	ECK-SS-248	8672	M	8880	EHB-SS-248	9630	M	9433	74
108"	ECB-SS-249	9526	M	9755	EHB-SS-249	10476	M	10718	ECK-SS-249	9729	M	9966	EHB-SS-249	9836	M	10673	83
120"	ECB-SS-2410	9822	M	10058	EHB-SS-2410	10766	M	11025	ECK-SS-2410	10021	M	10260	EHB-SS-2410	10107	M	10965	92
<b>30" WIDE TABLES</b>																	
36"	N/A			EHB-SS-303	\$6146		\$6828	N/A			EHB-SS-303	\$6957	M	\$7133	35		
48"	ECB-SS-304	\$6198	M	\$6348	EHB-SS-304	6422	M	7135	ECK-SS-304	\$6327	M	\$6480	EHB-SS-304	7274	M	7449	45
60"	ECB-SS-305	6687	M	6848	EHB-SS-305	6878	M	7642	ECK-SS-305	6834	M	6999	EHB-SS-305	7782	M	7970	55
72"	ECB-SS-306	7184	M	7359	EHB-SS-306	7322	M	8135	ECK-SS-306	7342	M	7520	EHB-SS-306	8288	M	8487	66
84"	ECB-SS-307	8082	M	8278	EHB-SS-307	8127	M	9030	ECK-SS-307	8251	M	8450	EHB-SS-307	9206	M	9433	76
96"	ECB-SS-308	8849	M	9066	EHB-SS-308	8816	M	9795	ECK-SS-308	9025	M	9241	EHB-SS-308	10566	M	10831	87
108"	ECB-SS-309	9944	M	10183	EHB-SS-309	9808	M	10898	ECK-SS-309	10150	M	10391	EHB-SS-309	11097	M	11363	97
120"	ECB-SS-3010	10233	M	10479	EHB-SS-3010	10070	M	11457	ECK-SS-3010	10444	M	10695	EHB-SS-3010	11387	M	11660	107

## ADJUSTABLE MID SHELF FOR ENCLOSED BASE TABLES

TA-116 **\$1233 Per Section**

Add To Price of Enclosed Base Table with Fixed Mid Shelf (M)  
On Page 53.

(Shelves Over 36" In Length Require Multiple Sections With  
Center Partition. For Partial Shelves Add to Price  
of Shelf on Page 71.)

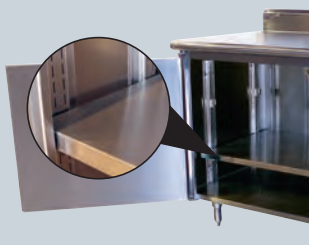

# TABLES

## Enclosed Base Tables

### 30" Wide Units!



Hinged Doors



Sliding Doors

## ENCLOSED BASE TABLES WITH DRAWERS

Featuring SHD Series NSF Drawers

Length	w/ Hinged Door		w/ Sliding Doors		# of Drawers	# of Doors	Weight	Cubic Feet
	Model #	Price	Model #	Price				
60"	HDRC-305	<b>\$11239</b>	SDRC-305	<b>\$11062</b>	2	2	300 lbs.	55
72"	HDRC-306	<b>11989</b>	SDRC-306	<b>11795</b>	2	4	360 lbs.	66
84"	HDRC-307	<b>14413</b>	SDRC-307	<b>14271</b>	3	4	420 lbs.	76
96"	HDRC-308	<b>14679</b>	SDRC-308	<b>14417</b>	3	4	540 lbs.	87
120"	HDRC-3010	<b>18554</b>	SDRC-3010	<b>18407</b>	4	4	600 lbs.	107

### MODIFICATIONS & ACCESSORIES

TA-105	Modified to 24" Width	<b>\$449</b> /table	TA-14	Drawer Lock	<b>\$206</b> ea.
TA-110	Modified to 36" Width	<b>84</b> /lin. ft.	TA-46	Door Lock	<b>474</b> ea.



## DISH CABINETS

Model #	Option	Price
TA-100F	Bullnose Front Top Edge	<b>\$163</b>
TA-101	Rear Tray Lock	<b>137</b> /lin. ft.
TA-61	Special Sizing Charge (From Next Larger Size)	<b>N/C</b>

Length	15" WIDE				18" WIDE			
	Model #	Weight	Cu. Ft.	Price	Model #	Weight	Cu. Ft.	Price
48"	DC-154	155 lbs.	21	<b>\$4346</b>	DC-184	170 lbs.	25	<b>\$4642</b>
60"	DC-155	195 lbs.	27	<b>4647</b>	DC-185	205 lbs.	31	<b>5017</b>
72"	DC-156	225 lbs.	32	<b>5167</b>	DC-186	245 lbs.	36	<b>6146</b>
84"	DC-157	265 lbs.	37	<b>5387</b>	DC-187	275 lbs.	41	<b>6632</b>
96"	DC-158	295 lbs.	42	<b>5786</b>	DC-188	315 lbs.	46	<b>7135</b>
120"	DC-1510	360 lbs.	52	<b>7102</b>	DC-1810	385 lbs.	56	<b>8071</b>
144"	DC-1512	400 lbs.	62	<b>7311</b>	DC-1812	425 lbs.	66	<b>8289</b>

### 30" Wide Units!



Model BEV-30-84L  
Shown

## BEVERAGE TABLES

Length	Model #	Price	Weight	Cu. Ft.
4'	BEV-30-48LorR*	<b>\$9721</b>	230 lbs.	37
5'	BEV-30-60LorR*	<b>10322</b>	250 lbs.	45
6'	BEV-30-72LorR*	<b>10971</b>	270 lbs.	54
7'	BEV-30-84LorR*	<b>12563</b>	290 lbs.	63
8'	BEV-30-96LorR*	<b>13358</b>	330 lbs.	71
9'	BEV-30-108LorR*	<b>20058</b>	360 lbs.	76
10'	BEV-30-120LorR*	<b>20131</b>	380 lbs.	88
12'	BEV-30-144LorR*	<b>20383</b>	430 lbs.	96

Specify Sink Left Or Right End:

\*Please Designate Left Or Right Sink Location By Using L Or R  
After Model Number When Ordering.

**Sink Size 14" x 16" x 12"**

Customize Your Own Beverage Table  
with Additional Accessories on Pages 64-71

TA-45 Optional Glass Rack Slide **\$905**

**Call For Installation of Buyout Equipment!**

# SINK CABINETS

## Sink Cabinets

Ship Via UPS

### SELF-CONTAINED MOBILE HAND SINKS



Bring The Sink On Location When Hand Washing Is Needed!

- 16 Ga., 304 Stainless Steel Top.
- K-52 Deck Mt. Gooseneck Faucet.
- Door Latch.
- 4" Plate Casters - 2 with Brakes.
- Hinged Door.
- Operates on a 120 Volt/15 Amp Circuit.
- 2-1/2 Gallon Electric Hot Water Heater (See Models Below).
- 6 Ft. Power Cord.
- Removable Plastic Container(s) for Fresh Water.
- Removable Plastic Container(s) for Waste Water.



SHK-MSC-26C Shown

w/ Cold Water Supply Only				w/ Hot & Cold Water Supply				Size L x W	Sink Bowl	Capacity (Gal.) Fresh/Waste
Model #	Dry Weight	Cu. Ft.	Price	Model #	Dry Weight	Cu. Ft.	Price			
SHK-MSC-26C	165 lbs.	21	<b>\$10314</b>	SHK-MSC-26CH	175 lbs.	21	<b>\$10950</b>	26" x 26"	10" x 14" x 5"	5/7
SHK-MSC-31C	185 lbs.	25	<b>10674</b>	SHK-MSC-31CH	195 lbs.	25	<b>11589</b>	31" x 26"	10" x 14" x 5"	10/14

### SELF-CONTAINED MOBILE HAND SINK ACCESSORIES & MODIFICATIONS



TA-MSC-1 Shown



TA-MSC-ES1 Shown

TA-MSC-1	Bolt-on Towel/Manual Soap Dispenser w/ Drip Tray for 26" Unit	<b>\$1049</b>
TA-MSC-2	Bolt-on Towel/Manual Soap Dispenser w/ Drip Tray for 31" Unit	<b>1393</b>
TA-MSC-ES1	Bolt-on Towel/Touchless Soap Dispenser w/ Drip Tray for 26" Unit	<b>1358</b>
TA-MSC-ES2	Bolt-on Towel/Touchless Soap Dispenser w/ Drip Tray for 31" Unit	<b>1733</b>
TA-MSC-PC	10 ft. Power Cord	<b>376</b>
TA-46	Door Lock	<b>474</b>
K-12	Deck Mounted Soap Dispenser	<b>222</b>
K-316-LU	Wrist Handles For Faucet	<b>175</b>

### CORNER SINK CABINET



- Furnished With A 5" Splash With A 1" Return.
- SHK-2441 Designed To Line Up With "HK" 5" Rear Splash Enclosed Base Tables To Create Functional Work Area.
- Door Is A Double Panel Design.
- Utility Access Clearance Provided For Ease Of Plumbing Installation.
- Includes Sink With K-124 6" Extended Spout Faucet & Drain.
- Mitered Front Permits Easy Access To Sink Bowl & Faucet.



SHK-2441 Shown with Enclosed Base Line-Up.  
For Enclosed Base Table Options, See Pages 53, 64-71.

Model #	Size	Sink Bowl	Weight	Cu. Ft.	Price
	L x W				
SHK-1735	17" x 35"	14" x 10" x 10"	215 lbs.	38	<b>\$7984</b>
SHK-2441	24" x 41"	16" x 20" x 12"	250 lbs.	50	<b>8786</b>

STAND ALONE UNIT

### STANDARD SINK CABINET



- 5" Splash With A 1" Return On The Rear Side.
- Includes Sink And K-124 6" Extended Faucet & Drain.
- Hinged Door.

Model #	Size	Sink Bowl	Dry Weight	Cu. Ft.	Price
	L x W				
SHK-302	24" x 30"	10" x 14" x 10"	150 lbs.	30	<b>\$6988</b>

#### Space Saver Sink Cabinet

SHK-180	18" x 30"	10" x 14" x 10"	125 lbs.	30	<b>6390</b>
---------	-----------	-----------------	----------	----	-------------



Add a 5" SIDE SPLASH  
TA-31 **\$254 ea.**

# WALL CABINETS

Wall Cabinets

## 15" WIDE STAINLESS STEEL WALL CABINETS



18 Gauge, 430 Stainless Steel Includes Fixed Mid-Shelf

OPEN UNIT

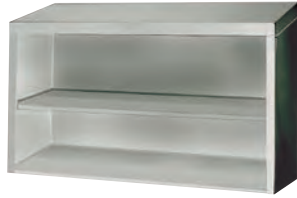

SLIDING DOOR



HINGED DOORS



Size L x W x H	OPEN UNIT			W/ SLIDING DOORS				W/ HINGED DOORS				Approx. Cu. Ft.
	Model #	Price	Approx. Weight	Model #	Price	Doors	Approx. Weight	Model #	Price	Doors	Approx. Weight	
36" x 15" x 32-1/2"	WCO-15-36	\$4200	95 lbs.	WCS-15-36	\$6600	2	130 lbs.	WCH-15-36	\$5995	2	120 lbs.	17
48" x 15" x 32-1/2"	WCO-15-48	4980	120 lbs.	WCS-15-48	7100	2	155 lbs.	WCH-15-48	6910	2	150 lbs.	21
60" x 15" x 32-1/2"	WCO-15-60	5575	145 lbs.	WCS-15-60	7600	2	185 lbs.	WCH-15-60	7500	2	180 lbs.	26
72" x 15" x 32-1/2"	WCO-15-72	6440	180 lbs.	WCS-15-72	8800	2	220 lbs.	WCH-15-72	8700	4	240 lbs.	31
96" x 15" x 32-1/2"	WCO-15-96	7200	240 lbs.	WCS-15-96	9775	4	295 lbs.	WCH-15-96	9545	4	320 lbs.	41

## STORAGE CABINETS



### 84" High Storage Cabinet w/ 4 Fixed Mid-Shelves

- Single Left-Hinged Door\*
- 4 Fixed Stainless Steel Mid-Shelves
- Enclosed Back Panel
- Ventilation Slots

Overall Size: 25"L x 22-5/8"W x 84"H

**CAB-4 \$8960**  
18 Gauge, 430 Stainless Steel

**CAB-4-300 \$9836**  
18 Gauge, 300 Stainless Steel



Vented Side Panels



### Wall Mounted Chemical Storage Cabinet w/ 1 Fixed Mid-Shelf

- Left-Hinged Door\*
- Vented Side Panels
- Mounting Hardware Not Included

Overall Size: 24"L x 15"W x 32-1/2"H

**WCH-15-24 \$4433**  
18 Gauge, 430 Stainless Steel

**WCH-15-24-300 \$6860**  
18 Gauge, 300 Stainless Steel

WCH-15-24 Left Hinged Shown (Standard)

\*Optional Right-Hand Door Swing Available - Add CAB-R N/C

## CABINET ACCESSORIES & MODIFICATIONS



Adjustable Mid-Shelf

**TA-115 \$205 per lin. ft.**  
Add to Price of 84" High Storage Cabinets or Wall Cabinets



Additional Fixed Mid-Shelf

**WC-SHELF \$131 per lin. ft.** For WCS, WCO, WCH Series Wall Cabinets  
**K-94-SHELF \$547 ea.** For 84" High Storage Cabinet

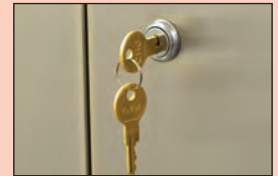

Cabinet Door Lock

**TA-46 \$474**  
One Per Hinged Door or Pair of Sliding Doors

## STAINLESS STEEL WALL FLASHING

- Wall Flashing Supplied in 10' Lengths
- Type 304 Stainless Steel
- Polished to a Commercial Grade #3 Finish

Model #	Gauge	Price
WF16	16	\$65 sq/ft.
WF18	18	\$61 sq/ft.
WF20	20	\$53 sq/ft.

### Optional Accessories

Model #	Style	Price
WF-EC-1	Edge Cap	\$131 ea.
WF-SC-1	Seam Cap	\$131 ea.
WF-IC-1	Inside Corner Cap	\$152 ea.



# SPECIALTY TABLES

## Specialty Tables

### DEMO TABLE

Countertop Edge Mirror Tilts to Desired Position



Model #	Table Size	Mirror Size	Wt.	Cu.	Price
VSS-DT-365	36" x 60"	24" x 48"	275 lbs.	18	<b>\$11815</b>
VSS-DT-366	36" x 72"	24" x 60"	305 lbs.	23	<b>13909</b>

### CEILING MOUNTED DEMO MIRROR

- 16 ga. type 304 Stainless Steel
- 1 5/8" Tubing - 4' Posts
- 14 ga. Rainbow Uprights For Added Support
- Glass Mirror



Model #	Mirror Size	Wt.	Cu.	Price
MI-48	24" x 48"	91 lbs.	7	<b>\$6640</b>
MI-60	24" x 60"	115 lbs.	8	<b>7792</b>

Mirror Tilts to Desired Position

PRINT REQUIRED

### CORNER TABLES 14 Gauge, 304 Stainless Steel 5" Rear Splash (1" Return)

Length	24" WIDE		30" WIDE		Wt.	Cu. Ft.
	Model #	Price	Model #	Price		
5'	KTMS-245	<b>\$10076</b>	KTMS-305	<b>\$10284</b>	280 lbs.	30
6'	KTMS-246	<b>10284</b>	KTMS-306	<b>10487</b>	300 lbs.	35
7'	KTMS-247	<b>10487</b>	KTMS-307	<b>10694</b>	320 lbs.	40
8'	KTMS-248	<b>10694</b>	KTMS-308	<b>10898</b>	345 lbs.	45
9'	KTMS-249	<b>10898</b>	KTMS-309	<b>11106</b>	375 lbs.	50
10'	KTMS-2410	<b>11106</b>	KTMS-3010	<b>11312</b>	400 lbs.	55
11'	KTMS-2411	<b>11312</b>	KTMS-3011	<b>11515</b>	425 lbs.	60
12'	KTMS-2412	<b>11722</b>	KTMS-3012	<b>11927</b>	450 lbs.	65

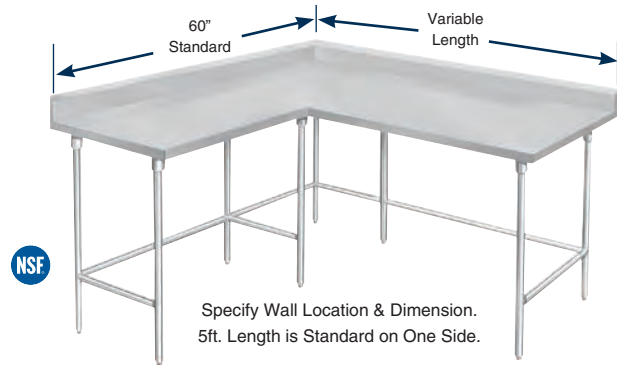

Specify Wall Location & Dimension. 5ft. Length is Standard on One Side.

(Length can be modified, but not to exceed 7 ft. on one wall dimension)

TA-57 **\$336** Prepare Welded Field Joint

### Accessories

KT-100	36" Width On Corner Tables	<b>\$212 /lin.ft.</b>	KT-103	Stainless Steel Undershelf	<b>\$89 /lin.ft.</b>
KT-101	Additional Length in Excess of 5'	<b>250 /lin.ft.</b>	KT-104	Stainless Steel Cabinet Base	<b>538 /lin.ft.</b>
KT-102	Special Sizing Charge	<b>N/C</b>			<i>(Top Is Shipped Separately For Ease In Installation)</i>

### WORK TABLE WITH PREP SINK & FAUCET



- 16 ga., 304 Stainless Steel Top
- 5" Rear Splash
- 16" x 20" x 12" Sink Bowl
- Stainless Steel Adjustable Undershelf
- 4 O.C. Deck Mounted Faucet & Basket Drain Included
- Stainless Steel Legs & Bullet Feet

Size	Model #	Sink Location	Price
30" x 48"	KMS-11B-304L	Left	<b>\$4743</b>
30" x 48"	KMS-11B-304R	Right	<b>4743</b>
30" x 60"	KMS-11B-305L	Left	<b>4981</b>
30" x 60"	KMS-11B-305R	Right	<b>4981</b>
30" x 72"	KMS-11B-306L	Left	<b>5206</b>
30" x 72"	KMS-11B-306R	Right	<b>5206</b>

CHOOSE LEFT OR RIGHT SINK POSITION

### PREP TABLE WITH COUNTERTOP EDGE



- 10" Rear Splash
- Includes 1 - 16" x 20" x 8" & 1 - 16" x 20" x 4" Integrally Welded Stainless Steel Sinks
- 21" x 18" x 5/8" Poly-Vance Cutting Board
- Stainless Steel Die-Formed Drawer
- Includes K-55 4" O.C. Gooseneck Faucet.

Model #	Size	Weight	Cu. Ft.	Price
DL-30-72	30" x 72"	155 lbs.	36	<b>\$9043</b>
DL-30-96	30" x 96"	198 lbs.	47	<b>10087</b>

See Page 68 For Additional Integral Sink Sizes

### MIXER TABLE WITH UTENSIL RACK

24" Work Height to Top of Table (Utensil Rack Has Height of 78")

Size	Stainless Steel Base		Galvanized Base		Wt.	Cu. Ft.
24" x 24"	<b>MX-SS-242</b>	<b>\$2940</b>	<b>MX-GL-242</b>	<b>\$2550</b>	53 lbs.	3
24" x 30"	<b>MX-SS-302</b>	<b>3042</b>	<b>MX-GL-302</b>	<b>2605</b>	63 lbs.	4
30" x 30"	<b>MX-SS-300</b>	<b>3266</b>	<b>MX-GL-300</b>	<b>2784</b>	70 lbs.	5
30" x 36"	<b>MX-SS-303</b>	<b>3311</b>	<b>MX-GL-303</b>	<b>2821</b>	77 lbs.	6
36" x 36"	<b>MX-SS-363</b>	<b>3400</b>	<b>MX-GL-363</b>	<b>2912</b>	81 lbs.	7



MX-SS-242  
Shown  
Mixer Not Included

### MIXER TABLE WITH UNDERSHELF

24" Work Height

Size	Stainless Steel Base		Galvanized Base		Wt.	Cu. Ft.
24" x 24"	<b>MT-SS-242</b>	<b>\$1759</b>	<b>MT-GL-242</b>	<b>\$1446</b>	45 lbs.	3
24" x 30"	<b>MT-SS-302</b>	<b>1848</b>	<b>MT-GL-302</b>	<b>1510</b>	50 lbs.	4
30" x 30"	<b>MT-SS-300</b>	<b>2095</b>	<b>MT-GL-300</b>	<b>1683</b>	55 lbs.	5
30" x 36"	<b>MT-SS-303</b>	<b>2127</b>	<b>MT-GL-303</b>	<b>1729</b>	68 lbs.	6
36" x 36"	<b>MT-SS-363</b>	<b>2230</b>	<b>MT-GL-363</b>	<b>1808</b>	71 lbs.	7



MT-SS-242  
Shown

### BUDGET MIXER TABLES

24" Work Height

Size	Stainless Steel Base		Galvanized Base		Wt.	Cu. Ft.
24" x 24"	<b>SAG-MT-242</b>	<b>\$1592</b>	<b>AG-MT-242</b>	<b>\$1292</b>	38 lbs.	3
24" x 30"	<b>SAG-MT-302</b>	<b>1672</b>	<b>AG-MT-302</b>	<b>1326</b>	41 lbs.	4
30" x 30"	<b>SAG-MT-300</b>	<b>1706</b>	<b>AG-MT-300</b>	<b>1353</b>	52 lbs.	5
30" x 36"	<b>SAG-MT-303</b>	<b>1820</b>	<b>AG-MT-303</b>	<b>1422</b>	58 lbs.	6
36" x 36"	<b>SAG-MT-363</b>	<b>1918</b>	<b>AG-MT-363</b>	<b>1517</b>	64 lbs.	7



AG-MT-242  
Shown

### MOBILE MIXER TABLES WITH TRAY SLIDES & CASTERS

28" Work Height. Tray Slides Have 2" Spacing

Size	Stainless Steel Base		Galvanized Base		Wt.	Cu. Ft.
30" x 30"	<b>MT-MS-300</b>	<b>\$3096</b>	<b>MT-MG-300</b>	<b>\$2688</b>	85 lbs.	9
30" x 36"	<b>MT-MS-303</b>	<b>3136</b>	<b>MT-MG-303</b>	<b>2736</b>	95 lbs.	10



MT-MG-300  
Shown

### MIXER EQUIPMENT TABLE

28" Work Height

Size	Model #	Price	Wt.	Cu. Ft.
24" x 30"	<b>AG-MP-30</b>	<b>\$2633</b>	65 lbs.	4

Shown with  
Optional Drawer



Add 15" x 20" Drawer SS-1520 **\$831**



#### CASTERS

MAINTAINS 24" WORKING HEIGHT

5" Swivels Each Set with 2 Brakes

For Use with  
Stainless Steel Legs

TA-25ES **\$624 set/4**

For Use with  
Galvanized Legs

TA-25EG **\$624 set/4**

### WALL MOUNTED TABLES

Must Be Installed In Cinder Block Wall  
Or Equal For Necessary Support



- Rolled Rim
- 1 1/2" Backsplash

24" WIDE	Length	Model #	Price
	30"	<b>FSS-W-240</b>	<b>\$2237</b>
	24"	<b>FSS-W-242</b>	<b>2030</b>
	36"	<b>FSS-W-243</b>	<b>2237</b>
	48"	<b>FSS-W-244</b>	<b>2424</b>
	60"	<b>FSS-W-245</b>	<b>2647</b>
	72"	<b>FSS-W-246</b>	<b>2853</b>
	84"	<b>FSS-W-247</b>	<b>3842</b>

30" WIDE	Length	Model #	Price
	30"	<b>FSS-W-300</b>	<b>\$2352</b>
	24"	<b>FSS-W-302</b>	<b>2113</b>
	36"	<b>FSS-W-303</b>	<b>2422</b>
	48"	<b>FSS-W-304</b>	<b>2600</b>
	60"	<b>FSS-W-305</b>	<b>2857</b>
	72"	<b>FSS-W-306</b>	<b>3108</b>
	84"	<b>FSS-W-307</b>	<b>3999</b>

# STANDS

## Equipment Stands

Ship Via UPS



### EQUIPMENT STANDS WITH UNDERSHELF



24" Working Height • 14 Ga. Type 304 Series • Up to 1000 lb. Load Capacity

Length	Stainless Steel				Galvanized				Wt.	Cu. Ft.
	24" WIDE	Price	30" WIDE	Price	24" WIDE	Price	30" WIDE	Price		
2'	ES-242	\$1885	ES-302	\$1973	EG-242	\$1652	EG-302	\$1691	43 lbs.	4
3'	ES-243	2093	ES-303	2210	EG-243	1823	EG-303	1890	56 lbs.	6
4'	ES-244	2293	ES-304	2459	EG-244	2049	EG-304	2102	74 lbs.	8
5'	ES-245	2501	ES-305	2714	EG-245	2166	EG-305	2316	84 lbs.	9
6'	ES-246	2706	ES-306	2956	EG-246	2337	EG-306	2522	102 lbs.	11
7'	ES-247	3375	ES-307	4531	EG-247	2864	EG-307	3934	120 lbs.	13
8'	ES-248	3450	ES-308	4610	EG-248	2936	EG-308	4011	135 lbs.	15



**Optional Heavy Duty Casters**  
 TA-255 Set of 4 **\$831**  
 TA-256 Set of 6 **1099**  
 Each set supplied with 2 Brakes

For 36" Wide Equipment Stands Add TA-59 \$392 per table

### EQUIPMENT STANDS WITH UNDERSHELF & CASTERS



24" Working Height • 14 Ga. Type 304 Stainless Steel • Up to 1000 lb. Load Capacity



Length	30" WIDE	Price	Wt.	Cu. Ft.
2'	ES-302C	\$2742	51 lbs.	4
3'	ES-303C	2977	68 lbs.	6
4'	ES-304C	3219	85 lbs.	8
5'	ES-305C	3465	102 lbs.	9
6'	ES-306C	3698	119 lbs.	11



Wood Top Cutting Board w/ Plate Shelf Shown\*

\*Must Order Cutting Board When Ordering Plate Shelf

### MOBILE MACHINE STAND WITH WELDED SET-UP

14 Ga. Type 304 Stainless Steel



- Square Edge On All Four Sides
- 25" W x 30" L x 20" H
- 1 5/8" Stainless Steel Legs with Heavy Duty Casters and Brakes
- Welded Undershelf

MT-SS-250C  
\$1908



### Optional Equipment Stand Accessories

L	Adj. Wood Cutting Board		Adj. S/S Plate Shelf		Wt.	Cu. Ft.
	Model #	Price	Model #	Price		
2'	TA-922	\$749	TA-962	\$725	28 lbs.	1
3'	TA-923	847	TA-963	819	30 lbs.	2
4'	TA-924	950	TA-964	904	34 lbs.	3
5'	TA-925	1052	TA-965	1003	37 lbs.	3
6'	TA-926	1159	TA-966	1096	40 lbs.	4
7'	TA-927	1361	TA-967	1362	56 lbs.	5
8'	TA-928	1556	TA-968	1586	64 lbs.	5

### EQUIPMENT FILLER TABLES



- Heavy Gauge Stainless Steel
- 1-1/2" Backsplash
- Stainless Steel Legs
- Stainless Steel Adjustable Bullet Feet



All Filler Tables Must Be Placed Between 2 Other Pieces Of Equipment For Stability.



#### Open Base

Size	Model #	Price	Wt.	Cu. Ft.
12" x 24"	TFMS-122	\$751	22 lbs.	2
12" x 30"	TFMS-120	761	31 lbs.	2
12" x 36"	TFMS-123	835	39 lbs.	2
15" x 24"	TFMS-152	840	25 lbs.	2
15" x 30"	TFMS-150	842	33 lbs.	2
15" x 36"	TFMS-153	856	41 lbs.	3
18" x 24"	TFMS-182	861	27 lbs.	2
18" x 30"	TFMS-180	863	35 lbs.	3
18" x 36"	TFMS-183	869	43 lbs.	3

#### w/ Adjustable Stainless Steel Undershelf

Size	Model #	Price	Wt.	Cu. Ft.
15" x 24"	TFMSU-152	\$898	28 lbs.	2
15" x 30"	TFMSU-150	919	36 lbs.	2
15" x 36"	TFMSU-153	1260	41 lbs.	3
18" x 24"	TFMSU-182	1255	38 lbs.	2
18" x 30"	TFMSU-180	940	41 lbs.	3
18" x 36"	TFMSU-183	1286	52 lbs.	3



All Wood Top Bakers Tables  
On Page 58 & 59 Feature  
1-3/4" Thick Wood Top



# WOOD TOPS

## Wood Top Bakers Tables

### FLAT TOP - OPEN BASE STYLE

= Ship Via UPS

#### Stainless Steel Base

L	24" WIDE	Price	Wt. (lbs.)	Cu. Ft.	30" WIDE	Price	Wt. (lbs.)	Cu. Ft.	36" WIDE	Price	Wt. (lbs.)	Cu. Ft.
4'	TH2S-244	\$1799	80	6	TH2S-304	\$2059	100	7	TH2S-364	\$2739	115	8
5'	TH2S-245	2014	95	7	TH2S-305	2347	120	9	TH2S-365	3123	135	11
6'	TH2S-246	2242	115	9	TH2S-306	2631	140	11	TH2S-366	3514	155	13
7'	TH2S-247	2758	135	10	TH2S-307	3301	155	12	TH2S-367	4398	180	15
8'	TH2S-248	2799	155	12	TH2S-308	3677	185	14	TH2S-368	4780	215	17



#### Galvanized Base

L	24" WIDE	Price	Wt. (lbs.)	Cu. Ft.	30" WIDE	Price	Wt. (lbs.)	Cu. Ft.	36" WIDE	Price	Wt. (lbs.)	Cu. Ft.
4'	TH2G-244	\$1413	80	6	TH2G-304	\$1580	100	7	TH2G-364	\$1890	115	8
5'	TH2G-245	1562	95	7	TH2G-305	1782	120	9	TH2G-365	2103	135	11
6'	TH2G-246	1712	115	9	TH2G-306	1975	140	11	TH2G-366	2306	155	13
7'	TH2G-247	2083	135	10	TH2G-307	2462	155	12	TH2G-367	3027	180	15
8'	TH2G-248	2455	155	12	TH2G-308	2848	185	14	TH2G-368	3069	215	17

### FLAT TOP - WITH ADJUSTABLE UNDERSHELF

#### Stainless Steel Base

L	24" WIDE	Price	Wt. (lbs.)	Cu. Ft.	30" WIDE	Price	Wt. (lbs.)	Cu. Ft.	36" WIDE	Price	Wt. (lbs.)	Cu. Ft.
3'	H2S-243	\$1799	75	4	H2S-303	\$2052	90	5	H2S-363	\$2707	105	6
4'	H2S-244	1912	95	6	H2S-304	2171	115	7	H2S-364	2816	135	8
5'	H2S-245	2171	110	7	H2S-305	2485	140	9	H2S-365	3237	160	11
6'	H2S-246	2424	130	9	H2S-306	2809	160	11	H2S-366	3647	185	13
7'	H2S-247	3009	150	10	H2S-307	3536	185	12	H2S-367	4600	215	15
8'	H2S-248	3386	180	12	H2S-308	3913	215	14	H2S-368	4981	255	17



#### Galvanized Base

L	24" WIDE	Price	Wt. (lbs.)	Cu. Ft.	30" WIDE	Price	Wt. (lbs.)	Cu. Ft.	36" WIDE	Price	Wt. (lbs.)	Cu. Ft.
3'	H2G-243	\$1476	75	4	H2G-303	\$1641	90	5	H2G-363	\$1952	105	6
4'	H2G-244	1587	95	6	H2G-304	1751	115	7	H2G-364	2067	135	8
5'	H2G-245	1786	110	7	H2G-305	1990	140	9	H2G-365	2321	160	11
6'	H2G-246	1979	130	9	H2G-306	2227	160	11	H2G-366	2575	185	13
7'	H2G-247	2428	150	10	H2G-307	2816	185	12	H2G-367	3161	215	15
8'	H2G-248	2806	180	12	H2G-308	3195	215	14	H2G-368	3536	255	17

### COVED TOP w/ 4" SPLASH - OPEN BASE STYLE

Features Covered Risers & Allow For Easy Cleaning

#### Stainless Steel Base

Length	30" WIDE	Price	Wt.	Cu. Ft.	36" WIDE	Price	Wt.	Cu. Ft.
4'	TBS-304	\$4038	120	12	TBS-364	\$5308	120	14
5'	TBS-305	4309	150	15	TBS-365	5681	150	18
6'	TBS-306	5056	180	18	TBS-366	6481	180	21
7'	TBS-307	6131	210	21	TBS-367	8088	210	24
8'	TBS-308	6501	240	24	TBS-368	8464	240	28



#### Galvanized Base

Length	30" WIDE	Price	Wt.	Cu. Ft.	36" WIDE	Price	Wt.	Cu. Ft.
4'	TBG-304	\$3065	120	12	TBG-364	\$4038	120	14
5'	TBG-305	3279	150	15	TBG-365	4343	150	18
6'	TBG-306	3939	180	18	TBG-366	5204	180	21
7'	TBG-307	5027	210	21	TBG-367	6655	210	24
8'	TBG-308	5401	240	24	TBG-368	7031	240	28

For Special Sizes & Configurations Of Wood Top Tables, Consult Factory.

For Additional Accessories & Modifications See Page 64 - 71 for Details



All Wood Tops are a non-stock special order item & may not be canceled once ordered.

# WOOD TOPS

## Wood Top Tables



### COVED TOP W/ 4" SPLASH & ADJUSTABLE UNDERSHELF



#### Stainless Steel Base

L	30" WIDE			36" WIDE				
	Price	Wt.	Cu. Ft.	Price	Wt. (lbs.)	Cu. Ft.		
4'	BS-304	\$4219	160	15	BS-364	\$5489	190	17
5'	BS-305	4766	185	18	BS-365	5909	220	21
6'	BS-306	5453	225	21	BS-366	6863	265	25
7'	BS-307	6815	240	25	BS-367	8459	290	29
8'	BS-308	7206	275	28	BS-368	8832	350	33

#### Galvanized Base

L	30" WIDE			36" WIDE				
	Price	Wt.	Cu. Ft.	Price	Wt. (lbs.)	Cu. Ft.		
4'	BG-304	\$3246	160	15	BG-364	\$4219	190	17
5'	BG-305	3510	185	18	BG-365	4560	220	21
6'	BG-306	4216	225	21	BG-366	5487	265	25
7'	BG-307	5393	240	25	BG-367	7018	290	29
8'	BG-308	5768	275	28	BG-368	7395	350	33

### COVED TOP W/ 4" SPLASH & 3-TIER DRAWERS

#### Optional Drawer Locks

TA-14SHD  
Drawer Lock For SHD Drawers  
**\$218**



BST-306L Shown

#### Stainless Steel Base

L	30" WIDE			36" WIDE				
	Price	Wt.	Cu. Ft.	Price	Wt. (lbs.)	Cu. Ft.		
4'	BST-304LorR	\$6725	365	46	BST-364LorR	\$8866	390	54
5'	BST-305LorR	7162	400	56	BST-365LorR	9307	430	66
6'	BST-306LorR	7720	440	67	BST-366LorR	10038	475	78
7'	BST-307LorR	8192	465	77	BST-367LorR	11369	505	91
8'	BST-308LorR	8566	500	87	BST-368LorR	11771	560	103

#### Galvanized Base

L	30" WIDE			36" WIDE				
	Price	Wt.	Cu. Ft.	Price	Wt. (lbs.)	Cu. Ft.		
4'	BGT-304LorR	\$5829	365	46	BGT-364LorR	\$7623	390	54
5'	BGT-305LorR	6045	400	56	BGT-365LorR	7866	430	66
6'	BGT-306LorR	6753	440	67	BGT-366LorR	8687	475	78
7'	BGT-307LorR	7912	465	77	BGT-367LorR	10049	505	91
8'	BGT-308LorR	8288	500	87	BGT-368LorR	10523	560	103



All Wood Tops are a non-stock special order item & may not be canceled once ordered.

# COUNTERTOPS

## Stainless Steel Countertops



- 16 Gauge Type 304 S/S
- #4 Satin Finish
- No-Drip "Mirror Hi-Lite Polish" Edge

- Stud Welded Hat Channel
- Sound Deadening

Countertop Shown with Optional Side Splash & Sink Bowl



Size	Flat Top			5" Backsplash			10" Backsplash					
	Price	Approx. Wt.	Approx. Cu. Ft.	Price	Approx. Wt.	Approx. Cu. Ft.	Price	Approx. Wt.	Approx. Cu. Ft.			
25" x 30"	VCTC-240	\$1802	28 lbs.	4	VCTF-240	\$2023	28 lbs.	4	VKCT-240	\$2251	28 lbs.	4
25" x 36"	VCTC-243	1802	39 lbs.	5	VCTF-243	2023	39 lbs.	5	VKCT-243	2251	39 lbs.	5
25" x 48"	VCTC-244	1990	49 lbs.	6	VCTF-244	2222	49 lbs.	6	VKCT-244	2476	49 lbs.	6
25" x 60"	VCTC-245	2189	58 lbs.	8	VCTF-245	2418	58 lbs.	8	VKCT-245	2691	58 lbs.	8
25" x 72"	VCTC-246	2378	68 lbs.	9	VCTF-246	2628	68 lbs.	9	VKCT-246	2919	68 lbs.	9
25" x 84"	VCTC-247	2942	85 lbs.	11	VCTF-247	3149	85 lbs.	11	VKCT-247	3500	85 lbs.	11
25" x 96"	VCTC-248	3154	95 lbs.	12	VCTF-248	3374	95 lbs.	12	VKCT-248	3740	95 lbs.	12
25" x 120"	VCTC-2410	4319	201 lbs.	26	VCTF-2410	4600	201 lbs.	26	VKCT-2410	5108	201 lbs.	26
30" x 30"	VCTC-300	1937	38 lbs.	5	VCTF-300	2126	38 lbs.	5	VKCT-300	2364	38 lbs.	5
30" x 36"	VCTC-303	1937	45 lbs.	6	VCTF-303	2126	45 lbs.	6	VKCT-303	2364	45 lbs.	6
30" x 48"	VCTC-304	2146	57 lbs.	8	VCTF-304	2368	57 lbs.	8	VKCT-304	2647	57 lbs.	8
30" x 60"	VCTC-305	2389	69 lbs.	9	VCTF-305	2618	69 lbs.	9	VKCT-305	2909	69 lbs.	9
30" x 72"	VCTC-306	2691	76 lbs.	11	VCTF-306	2856	76 lbs.	11	VKCT-306	3176	76 lbs.	11
30" x 84"	VCTC-307	3102	95 lbs.	13	VCTF-307	3299	95 lbs.	13	VKCT-307	3668	95 lbs.	13
30" x 96"	VCTC-308	3356	107 lbs.	15	VCTF-308	3381	107 lbs.	15	VKCT-308	4053	107 lbs.	15
30" x 120"	VCTC-3010	4820	235 lbs.	32	VCTF-3010	4929	235 lbs.	32	VKCT-3010	5487	235 lbs.	32

# POLY TOPS

## Poly Top Bakers Tables

### FLAT TOP Tubular Base



Length	24" WIDE	Price	30" WIDE	Price	Wt.	Cu. Ft.
4'	TSPT-244	<b>\$2297</b>	TSPT-304	<b>\$2487</b>	77 lbs.	8
5'	TSPT-245	<b>2516</b>	TSPT-305	<b>2691</b>	89 lbs.	9
6'	TSPT-246	<b>3359</b>	TSPT-306	<b>3558</b>	117 lbs.	11
7'	TSPT-247	<b>3743</b>	TSPT-307	<b>4095</b>	130 lbs.	13
8'	TSPT-248	<b>4127</b>	TSPT-308	<b>4280</b>	141 lbs.	15
9'	TSPT-249	<b>4362</b>	TSPT-309	<b>4600</b>	180 lbs.	17
10'	TSPT-2410	<b>4717</b>	TSPT-3010	<b>4843</b>	201 lbs.	19

### With Undershaft



Length	24" WIDE	Price	30" WIDE	Price	Wt.	Cu. Ft.
4'	SPT-244	<b>\$2461</b>	SPT-304	<b>\$2631</b>	89 lbs.	8
5'	SPT-245	<b>2676</b>	SPT-305	<b>2853</b>	102 lbs.	9
6'	SPT-246	<b>3491</b>	SPT-306	<b>3740</b>	125 lbs.	11
7'	SPT-247	<b>3902</b>	SPT-307	<b>4241</b>	141 lbs.	13
8'	SPT-248	<b>4274</b>	SPT-308	<b>4606</b>	168 lbs.	15
9'	SPT-249	<b>4523</b>	SPT-309	<b>4762</b>	196 lbs.	16
10'	SPT-2410	<b>4876</b>	SPT-3010	<b>5005</b>	230 lbs.	17

### 6" BACKSPLASH Tubular Base



Length	24" WIDE	Price	30" WIDE	Price	Wt.	Cu. Ft.
4'	TSPS-244	<b>\$2305</b>	TSPS-304	<b>\$2461</b>	87 lbs.	12
5'	TSPS-245	<b>2541</b>	TSPS-305	<b>2714</b>	101 lbs.	15
6'	TSPS-246	<b>3387</b>	TSPS-306	<b>3621</b>	131 lbs.	18
7'	TSPS-247	<b>3884</b>	TSPS-307	<b>4207</b>	145 lbs.	21
8'	TSPS-248	<b>4236</b>	TSPS-308	<b>4552</b>	160 lbs.	24
9'	TSPS-249	<b>4476</b>	TSPS-309	<b>4778</b>	210 lbs.	16
10'	TSPS-2410	<b>4753</b>	TSPS-3010	<b>4888</b>	235 lbs.	17

### With Undershaft



Length	24" WIDE	Price	30" WIDE	Price	Wt.	Cu. Ft.
4'	SPS-244	<b>\$2618</b>	SPS-304	<b>\$2790</b>	99 lbs.	12
5'	SPS-245	<b>2976</b>	SPS-305	<b>3040</b>	113 lbs.	15
6'	SPS-246	<b>3856</b>	SPS-306	<b>3935</b>	143 lbs.	18
7'	SPS-247	<b>4375</b>	SPS-307	<b>4524</b>	167 lbs.	21
8'	SPS-248	<b>4733</b>	SPS-308	<b>4815</b>	175 lbs.	24
9'	SPS-249	<b>4807</b>	SPS-309	<b>5095</b>	225 lbs.	25
10'	SPS-2410	<b>5075</b>	SPS-3010	<b>5211</b>	242 lbs.	28

## ACCESSORIES

TA-41	Replacement Poly-Vance 5/8" Cutting Board	<b>\$138</b> /sq. ft.
TA-63	Removable Shelving (In Addition To Standard Shelf)	<b>580</b> /table
TA-82	Scrap Chute	<b>368</b> ea.
SHD-2020	Enclosed Drawers - See Page 69 For Details	<b>1618</b> ea.



TA-84C Shown

### KNIFE RACKS

TA-84A	Rolled Rim Type	<b>\$538</b>
TA-84B	Poly Table Type	<b>538</b>
TA-84C	Square Edge Type	<b>538</b>

# TABLE MODS

## Smart Table Modifications

### TOP MODIFICATIONS



**TA-56**  
5" NSF Partition

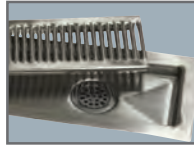

**TA-523**  
Drop-In Urn Trough



**CDR-5**  
Condiment Holder

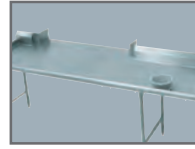

**TA-84**  
Pass-Thru



**TA-108**  
Grommet For Cords

<b>CDR-5</b>	Condiment Holder (Accommodates 5 Bins)	<b>\$1208</b>
<b>TA-1</b>	Notch Backsplash For Roll Up Door w/ Pass-Thru	<b>218</b>
<b>TA-3</b>	Stainless Steel Hat Channel & Gusset Upgrade	<b>83 /lin. ft.</b>
<b>TA-7</b>	10" Partial Splash	<b>117 /lin. ft.</b>
<b>TA-8</b>	Column Notch in Rear Splash (Includes Splash)	<b>1066 ea.</b>
<b>TA-10</b>	5" Partial Splash	<b>99 /lin. ft.</b>
<b>TA-12</b>	Countertop Edge	<b>981 /table</b>
<b>TA-22</b>	Square Edge Table	<b>N/C</b>
<b>TA-28</b>	Cut-Out For Cold Well. Includes Louvered Doors	<b>2266 /cut out</b>
<b>TA-29</b>	16 Ga. 304 Rear Splash Capping Strip with Adhesive Backing	<b>97 /lin. ft.</b>
<b>TA-30</b>	1-1/2" Side Splash	<b>137 ea.</b>
<b>TA-30A</b>	1-1/2" Turn Up For Table Tops	<b>62 /lin. ft.</b>
<b>TA-31</b>	5" Side Splash	<b>254 ea.</b>
<b>TA-32</b>	10" Side Splash	<b>498 ea.</b>
<b>TA-34</b>	Top Cut-Out for Drop-In Style Units	<b>373 /cut out</b>
<b>TA-34A</b>	Top Cut-Out for Undermount Well	<b>626 /cut out</b>
<b>TA-35</b>	Splash Cut-Out	<b>270 /cut out</b>
<b>TA-41</b>	Poly-Vance 5/8" Cutting Board	<b>138 /sq. ft.</b>
<b>TA-56</b>	5" NSF Partition	<b>683</b>
<b>TA-56A</b>	18" NSF Partition	<b>983</b>
<b>TA-57</b>	Prepare Welded Field Joint (Welded in field by others)	<b>377 ea.</b>
<b>TA-57A</b>	Bolted Field Joint (Bolted in field by others)	<b>797 ea.</b>
<b>TA-57B</b>	Hairline Bolted Field Joint	<b>1067 ea.</b>
<b>TA-58</b>	Stepdown to 24" Working Height	<b>1683 ea.</b>
<b>TA-64</b>	Urn Trough (Factory installation only)	<b>229 /lin. ft.</b>
<b>TA-75</b>	Mitered Edge	<b>1092 ea.</b>
<b>TA-76</b>	Paint on Sound Deadening	<b>783 /table</b>
<b>TA-79</b>	Flour Trough (Factory installation only)	<b>288 /lin. ft.</b>
<b>TA-82</b>	Scrap Chute (6" dia. opening)	<b>368</b>
<b>TA-84</b>	Simple Pass-Thru	<b>967 /lin. ft.</b>
<b>TA-87</b>	Enclosed Rear Splash	<b>137 /lin. ft.</b>
<b>TA-91</b>	Poly Retaining Clips Includes TA-22 (S/S top table)	<b>676 /table</b>

<b>TA-93</b>	Wall Brackets (Includes 2. For 5" & 10 1/2" splash only)	<b>117 /table</b>
<b>TA-96A</b>	Can Opener Provision for Openers with Bolt-on Base (Customer to provide location)	<b>\$324 ea.</b>
<b>TA-96B</b>	Can Opener Surface Mount Provision with 4" S/S Tube for Openers w/o Base (Customer to provide location)	<b>813 ea.</b>
<b>TA-96C</b>	Can Opener Spacer Plate Provision for Use on Tables With Countertop Edge & Can Opener Base (Customer to provide location)	<b>503 ea.</b>
<b>TA-100</b>	Bull Nose All Sides of Worktable	<b>N/C</b>
<b>TA-101</b>	Rear Tray Lock	<b>137 /lin. ft.</b>
<b>TA-106</b>	Mirror HI-LITE Edge	<b>610 /table</b>
<b>TA-107</b>	Vacuum Breaker Holes on Tables (Includes Backsplash with 2" Return)	<b>558</b>
<b>TA-108</b>	2" Hole with Grommet for Appliance Cord	<b>201 ea.</b>
<b>TA-112</b>	Hubble Outlet	<b>866 ea.</b>
<b>TA-113</b>	Notch Top for Buyout Unit	<b>1252 ea.</b>
<b>TA-366A</b>	Heavy Duty Understructure Top	<b>489 /table</b>
<b>TA-502</b>	Install Advance Tabco Drop-In Hand Sinks or Hot Food Unit In Work Table Top (Hot Food Unit Requires TA-34 Top Cut-Out & TA-27 Control Panel. Does not include wiring. Consult factory)	<b>812 ea.</b>
<b>TA-503</b>	Install Advance Tabco 7-PS-42/7-PS-43 Hand Sinks for Countertops (Includes Cut-Out)	<b>644 ea.</b>
<b>TA-521</b>	Drop-In urn Trough 1'	<b>227 ea.</b>
<b>TA-522</b>	Drop-In urn Trough 2'	<b>452 ea.</b>
<b>TA-523</b>	Drop-In urn Trough 3'	<b>679 ea.</b>
<b>TA-524</b>	Drop-In urn Trough 4'	<b>907 ea.</b>
<b>TA-525</b>	Drop-In urn Trough 5'	<b>937 ea.</b>
<b>TA-526</b>	Drop-In urn Trough 6'	<b>991 ea.</b>
<b>TA-527</b>	Drop-In urn Trough 7'	<b>1050 ea.</b>
<b>TA-528</b>	Drop-In urn Trough 8'	<b>1080 ea.</b>
<b>TA-529</b>	Drop-In urn Trough 9'	<b>1146 ea.</b>
<b>TA-550</b>	Install Customer Supplied Buyout Items (Does not include wiring. Consult factory)	<b>Call for Price</b>
<b>TA-551</b>	Installation of Customer Supplied Hot Food Wells. (Requires TA-34 Top Cut-Out & TA-27 Control Panel. Does not include wiring. Consult factory)	<b>1210 ea.</b>

Call For Installation of Buyout Equipment!

# TABLE MODS

## Smart Table Modifications

### BASE MODIFICATIONS

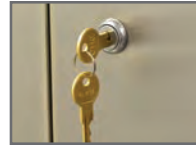
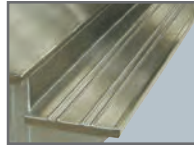
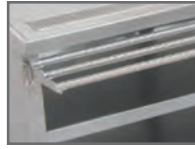

TA-39 Louvered Hinged Doors		TA-73 Drop-Down Tray Slide	TA-74 Solid Tray Slide
TA-4	Removable Access Panel	\$273 /lin. ft.	
TA-4A	Louvered Panel	739 /lin. ft.	
TA-5	Curb Mounting Provision	309 ea.	
TA-15	Provision for Built In Drawer Warmer	592 ea.	
TA-23	Legs Welded to Undershelf or Cross-Rails, Shipped Set Up & Crated.	589 /table	
TA-23A	Table Legs Welded To Leg Gussets & Undershelf or Cross-Bracing, Shipped Set Up & Crated.	778 /table	
TA-24	Shell Crating	435 /table	
TA-27	Control Panel (Must add TA-34A)	427 /lin. ft.	
TA-36-HINGED	Hinged 30" Stainless Steel Door	679 /door	
TA-36-SLIDING	Sliding 30" Stainless Steel Door	679 /door	
TA-36B	1/2 Height Stainless Steel Hinge Doors	690 set/2	
TA-36C	Hinged door with Trash Flap	951 /ea.	
TA-37	Stainless Enclosed Base	981 /lin. ft.	
TA-39	24" Louvered Hinged Doors	981 /door	
TA-40	Remove Undershelf in Cabinet Base For Slide in Buyout	N/C	
TA-42-24	Interior Partition (2.5"x24")	331 ea.	
TA-42-30	Interior Partition (2.5"x30")	331 ea.	
TA-42-36	Interior Partition (2.5"x36")	331 ea.	
TA-43	Filler Panel (3"x30" with Flanged Feet)	669 ea.	
TA-44	K.D. Aluminum Pan Rack Slides (6 slides. Table min. lgth. 30")	991	
TA-45	K.D. Aluminum Glass Rack Slides (3 slides. Table min. lgth. 3 feet)	905	

TA-46 Door Lock		TA-116 Adj. Mid-Shelf
TA-46	Door Lock	\$474 ea.
TA-48	12"x12" Cut-Out in Back Panel/Undershelf for Plumbing	354
TA-54	Removable Kick Plate	227 /lin. ft.
TA-55	Remove Back Panel (on Enclosed Base)	N/C
TA-63	Removable Shelving (In addition to standard shelf & table width)	580 /table.
TA-70	S/S Tubular Tray Divider (12" sections)	1080 ea.
TA-73	Tubular Tray Slide w/Dropdown (Stationary Tray Slide Available. Factory installation only)	393 /lin. ft.
TA-74	Solid Tray Slide	540 /lin. ft.
TA-92	12" Apron (in front of sink)	249 /lin. ft.
TA-92A	17" Stainless Steel Apron to Cover Sink Bowls and Support Lever Drain Handles	373 /lin. ft.
TA-116	Adjustable Enclosed Base Cabinet Mid Shelf- Add to Price of Enclosed Base Table with Fixed Mid Shelf (M) on Page 52 or 53. Shelves Over 36" In Length Require Multiple Sections With Center Partition. For Partial Shelves Add To Price Of Shelf On Page 71.	1233 ea.
TA-130	Cutlery Dispenser Holder (Undercounter Mounted)	332 /lin. ft.
TA-135	Plate Shelf (Undercounter Mounted)	396 /lin. ft.
TA-205	Connect Cafeteria Items (Per Joint Between 2 Tables. Requires Casters)	790 /set

### ELECTRICAL & DATA PORT OUTLETS



TA-62  
Duplex  
Outlet



TA-62A  
GFI Duplex  
Outlet



TA-62D  
GFI  
Doghouse  
Outlet



TA-62F  
Empty  
Junction  
Box



TA-112  
Hubble  
Outlet

TA-62A	GFI Duplex Outlet & Cover Plate in a VKS or KSS (1" Deep) Splash. NEMA 5-20R	\$579 ea.
TA-62C	GFI Duplex Outlet & Cover Plate Below Shelf Top. NEMA 5-20R	630 ea.
TA-62D	GFI Duplex Outlet & Cover Plate in a Doghouse. NEMA 5-20R	669 ea.

TA-62E	Upgrade Outlet to a NEMA 6-20R or Equiv.	\$443 ea.
TA-62F	Junction Box (empty) Below Table Top. Includes 1 Gang Size, Stainless Steel Face Plate	305 ea.
TA-112	Hubble Outlet	813 ea.
TA-622	CAT-6 Data Port Connection Provided (unless otherwise specified. Cable Not Included)	599 ea.

Email in your specifications to [smartfab@advancetabco.com](mailto:smartfab@advancetabco.com)

# MORE TABLE MODS

## Smart Table Modifications

### OVERSHELF & POT RACK MODIFICATIONS

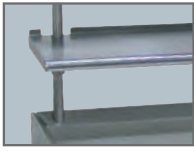

**TA-9A**  
1" Turn Up

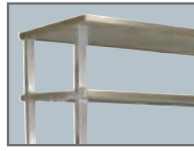

**TA-22A**  
Square Edge



**TA-71**  
Heat Lamp Mounting Provision



**TA-100A**  
Bull Nose

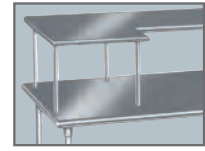

**TA-102**  
24" x 24" Extension

<b>TA-9A</b>	Partial 1" Turn-Up for all Table Mt. Shelves	<b>\$65 /lin. ft.</b>
<b>TA-22A</b>	Square Edge on Overshelf	<b>151</b>
<b>TA-26-10</b>	Welded Wall Shelf Brackets for 10" Wide Shelf	<b>376 /shelf</b>
<b>TA-26-12</b>	Welded Wall Shelf Brackets for 12" Wide Shelf	<b>376 /shelf</b>
<b>TA-26-15</b>	Welded Wall Shelf Brackets for 15" Wide Shelf	<b>376 /shelf</b>
<b>TA-26-18</b>	Welded Wall Shelf Brackets for 18" Wide Shelf	<b>376 /shelf</b>
<b>TA-47</b>	Shelf Mounting Bracket for Existing Table	<b>138 /shelf</b>
<b>TA-49</b>	Wall Shelf 2" Offset	<b>266 /shelf</b>
<b>TA-60</b>	Special Sizing Charge for Shelves (Must Order Larger Unit to be Cut Down to Smaller Size)	<b>N/C</b>
<b>TA-71</b>	Heat Lamp Mounting Provision (Heat Lamp Installed By Others)	<b>239 ea.</b>
<b>TA-71A</b>	Heat Lamp Remote Control Bracket	<b>470 ea.</b>
<b>TA-78</b>	Additional Lin. Ft. Past 12' For Table Mt. Shelf (For ODS, OTS, TS, DS & WS Shelving only)	<b>266 /lin. ft.</b>
<b>TA-77</b>	Check Minder Shelf Provision (Factory install only)	<b>85 /lin. ft.</b>
<b>TA-83</b>	Spice Bins	<b>345 ea.</b>

<b>TA-84A</b>	Knife Rack for Rolled Rim Tables	<b>\$538 ea.</b>
<b>TA-84B</b>	Knife Rack for Poly Top Tables	<b>538 ea.</b>
<b>TA-84C</b>	Knife Rack for Square Edge Tables	<b>538 ea.</b>
<b>TA-86</b>	Stainless Steel Pot Hooks	<b>36 ea.</b>
<b>TA-89</b>	Double Sided Plated Pot Hooks (Package of 4)	<b>96 /pack</b>
<b>TA-89A</b>	Single Sided Plated Pot Hooks (Package of 4)	<b>88 /pack</b>
<b>TA-98</b>	Stainless Steel Flat Bar in lieu of Chain	<b>435 ea.</b>
<b>TA-99</b>	16 Ga. S/S 304 Upgrade for Wall & Over Shelves	<b>37 /lin. ft.</b>
<b>TA-100A</b>	Bull Nose All Sides of Shelf	<b>151</b>
<b>TA-100R</b>	Bull Nose Three Sides of Shelf w/ Rear Turn Up	<b>173</b>
<b>TA-102</b>	24" x 24" Extension for Microwave or Computer Shelf (Add to OTS and ODS Shelves. See page 82)	<b>625 ea.</b>
<b>TA-103</b>	24" Wide PT Shelf (36" Min Length. Mid mt only. See Pg. 73. Add to 18" Wide Shelf)	<b>186 /lin. ft.</b>
<b>TA-104</b>	Additional Length Over 12' (Add to 18" Shelf. (PA & CU Shelving Only. Max. Length is 14' as Single Piece)	<b>402 /lin. ft.</b>

### UNDERSHELF MODIFICATIONS

<b>TA-9</b>	1-1/2" Turn-Up for Undershelves	<b>\$62 /lin. ft.</b>
<b>TA-17</b>	Upgrade Undershell to a Marine Edge (Must add TA-23)	<b>676 ea.</b>
<b>TA-48</b>	12"x12" Cut-Out in Back Panel/Undershell for Plumbing	<b>354</b>

<b>TA-94</b>	Upgrade 16 Ga. 304 S/S Undershell	<b>\$79 /lin. ft.</b>
<b>TA-94A</b>	Upgrade 14 Ga. 304 S/S Undershell	<b>100 /lin. ft.</b>
<b>TA-366</b>	Reinforced Understructure For Undershelves	<b>489 /table</b>

### SIZE MODIFICATIONS

<b>TA-33</b>	Special Working Height	<b>\$148</b>
<b>TA-33C</b>	Special Working Height For Enclosed Base Tables Up To 39" (For Heights Over 39", Contact Factory).	<b>373 ea.</b>
<b>TA-59</b>	36" Wide Equipment Stand	<b>427 ea.</b>
<b>TA-6</b>	Extra Length for Standard Tables Over 12' (Tables Over 14' Require Field Joint TA-57)	<b>564 /lin. ft.</b>
<b>TA-61</b>	Special Sizing Charge (Larger Unit Cut Down to Smaller Size)	<b>N/C</b>

<b>TA-61A</b>	Special Modification Charge	<b>\$373</b>
<b>TA-65</b>	Enclosed Base Units Over 12' (Open Base Table)	<b>732 /lin. ft.</b>
<b>TA-66</b>	Enclosed Base Units Over 12' (Sliding Door Units)	<b>1066 /lin. ft.</b>
<b>TA-67</b>	Enclosed Base Units Over 12' (Hinged Door Units)	<b>1130 /lin. ft.</b>
<b>TA-105</b>	Modify Enclosed Base Table w/ Drawers to 24" Width	<b>449 /table</b>
<b>TA-110</b>	Modify Enclosed Base Table w/ Drawers to 36" Width	<b>84 /lin. ft.</b>

### LEG MODIFICATIONS

<b>TA-16</b>	Galvanized Leg w/ Plastic Bullet Foot (3/4 1/2" Total Length)	<b>\$89 ea.</b>
<b>TA-16-4</b>	Galvanized Legs w/ Plastic Bullet Feet (3/4 1/2" Total Length)	<b>358 set/4</b>
<b>TA-16-6</b>	Galvanized Legs w/ Plastic Bullet Feet (3/4 1/2" Total Length)	<b>536 set/6</b>
<b>TA-19</b>	Flanged Stainless Steel Bullet Foot (3/4 1/2" Total Length)	<b>85 ea.</b>
<b>TA-19L</b>	Flanged S/S Bullet Foot For Enclosed Base Table	<b>117 ea.</b>
<b>TA-20</b>	Stainless Steel Leg w/ S/S Bullet Foot (3/4 1/2" Total Length)	<b>104 ea.</b>
<b>TA-20-4</b>	Stainless Steel Legs w/ S/S Bullet Feet (3/4 1/2" Total Length)	<b>412 set/4</b>

<b>TA-20-6</b>	Stainless Steel Legs w/ S/S Bullet Feet (3/4 1/2" Total Length)	<b>\$620 set/6</b>
<b>TA-21</b>	Stainless Steel Bullet Foot	<b>41 ea.</b>
<b>TA-68</b>	Relocate rear cross rail to center (for chairs/stools on both sides of table. For Open Base Tables Only)	<b>162 ea.</b>
<b>TA-72</b>	Leg to Wall Brace (Set per table)	<b>457 /table</b>
<b>TA-95</b>	Upgrade 16 Ga. 304 S/S Legs Only	<b>194 /table</b>

# TABLE ACCESSORIES

## Smart Table Accessories

Faucets Included Meet  
Federal Lead Free Standards



### COUNTERTOP INSTALLED HAND SINKS

- 4" Side Splashes
- K-52 Lead Free Compliant Deck Mounted Faucet
- Undermount Towel Dispenser
- 3-1/2" Basket Drain



#### 7-PS-42 \$4103

Bowl Size: 10" x 14" x 5"  
Overall Size: 18-1/4" x 17-5/8"  
30 lbs. 2 cu. ft. 20 gauge

- 4" Side Splashes
- Deck Mounted Lead Free Compliant Gooseneck Spout
- Undermount Towel Dispenser
- Knee Operated Valve
- 3-1/2" Basket Drain



#### 7-PS-43 \$4750

Bowl Size: 10" x 14" x 5"  
Overall Size: 18-1/4" x 17-5/8"  
36 lbs. 2 cu. ft. 20 gauge



7-PS-43 Shown in Table

For Factory Installation Add TA-503 \$644  
Can Be Purchased Separately For In-Field Installation

### DROP-IN HAND SINKS & WATER STATIONS

For Custom Cut-Out Add TA-34 \$323 For Factory Installation Add TA-502 \$703



#### DI-1-5SP \$2267

##### 6" Tapered Side Splash

Splash on Rear and Both Sides  
10" x 14" x 5" Bowl  
Overall: 13" x 19"  
Cut-out: 12 1/4" x 18 1/4"  
16 lbs. 2 cu. ft. 20 gauge



#### DI-1-10SP \$2435

##### 6" Tapered Side Splash

Splash on Rear and Both Sides  
10" x 14" x 10" Bowl  
Overall: 13" x 19"  
Cut-out: 12 1/4" x 18 1/4"  
18 lbs. 2 cu. ft. 20 gauge



#### DI-1-9 \$1539

Removable Electro-Polished  
Stainless Steel Grill  
1 1/2" IPS Basket Drain  
Overall: 12" x 14"  
Cut-Out Size: 11 1/4" x 13 1/4"  
15 lbs. 3 cu. Ft.

### Water Stations with Ice Bins

Includes K-54 8-1/4" Filler Faucet With "Push-Back" Acrylic Lever Arm (Excludes D-24-SIBL)

IMPROVED!  
Stronger Acuator



Ice Bin Inside Dim.:  
8" x 13 1/2" x 10 13/16"  
Ice Capacity: 23 lbs.

#### D-24-WSIBL \$2067

Removable Grate Covers Drip Pan  
13" Deep Insulated Ice Bin w/ S/S Steel Cover  
1" IPS Drain  
Outside Dim. 21" x 18"  
Cut-Out Size: 20 5/8" x 15 1/4"  
30 lbs. 5 cu. Ft.

IMPROVED!  
Stronger Acuator



Ice Bin Inside Dim.:  
13 1/2" x 18 3/4" x 10 13/16"  
Ice Capacity: 50 lbs.

#### D-24-WSIBL2 \$2473

Removable Grate Covers Drip Pan  
13" Deep Insulated Ice Bin w/ S/S Steel Cover  
1" IPS Drain  
Outside Dim.: 18" x 21"  
Cut-Out Size: 15 1/4" x 20 5/8"  
47 lbs. 5 cu. Ft.

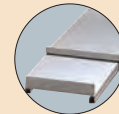

Includes Sliding  
Stainless Steel Cover



#### D-24-SIBL \$2209

K-51 Deck Mounted Faucet  
Insulated Ice Bin w/ S/S Cover  
1" IPS Drain In Ice Bin  
Outside Dim.: 21" x 18"  
Cut-Out Size: 20 5/8" x 15 1/4"  
Factory Installed Only  
20 Gauge Galvanized Steel  
30 lbs. 5 cu. Ft.

Hand Sink Size:  
9 1/2" x 11 1/2" x 6"

Ice Bin Inside Dim.:  
8" x 13 1/2" x 10 13/16"

Ice Capacity: 23 lbs.

Upgrade to a 12" Filler Faucet

Use K-54OMIT, Deduct -\$300 and Add K-54A \$887

(K-54OMIT MUST be ordered with K-54A to receive upgrade)



# INTEGRAL SINKS

## Integral Sinks

### WELDED SINKS INTO TABLE TOP

Includes Lead Free Compliant Faucet & K-6 Basket Drain(s)



Flat Top, 1", 1-1/2" & 5 Backsplash Include Deck Mount Faucet

- Single Sink Bowl provided with K-50 Swing Spout Faucet
- Double Sink Bowls provided with K-53 Swing Spout Faucet

10" Backsplash Include Splash Mount Faucet

- Single & Double Sink Bowls provided with K-1 Swing Spout Faucet
- Splash Mount Faucet Available On 5" Backsplash - Add TA-11Z \$62/lin. ft.



Flat Top  
w/ K-50  
Deck Mount  
Faucet Shown



10" Backsplash  
w/ K-1  
Splash Mount  
Faucet Shown

Size		Single Bowl		Double Bowl	
A	B	Model#	Price	Model#	Price
10" x 14" x 5"		TA-11Q	\$1675	TA-11Q-2†	\$3060
10" x 14" x 10"		TA-11F	1803	TA-11F-2†	3449
14" x 16" x 12"		TA-11J	1897	TA-11J-2	3549
16" x 20" x 8"		TA-11A**	1885	TA-11A-2**	3507
16" x 20" x 12"		TA-11B**	2105	TA-11B-2**	3870
16" x 20" x 14"		TA-11V**	2450	TA-11V-2**	4155
16" x 24" x 14"		TA-11K**	2458	TA-11K-2**	4164
18" x 18" x 14"		TA-11N	2148	TA-11N-2	3877
18" x 24" x 14"		TA-11L	2175	TA-11L-2	3908
20" x 20" x 8"		TA-11C*	1990	TA-11C-2*	3848
20" x 20" x 12"		TA-11D*	2265	TA-11D-2*	4073
20" x 20" x 14"		TA-11W*	2308	TA-11W-2*	4146
20" x 24" x 14"		TA-11P*	2372	TA-11P-2*	4356
30" x 20" x 14"		TA-11S*	2519	TA-11S-2*	4692
24" x 24" x 14"		TA-11E*	2590	TA-11E-2*	4460
30" x 24" x 14"		TA-11T*	2644	TA-11T-2*	4938
36" x 24" x 14"		TA-11R*	2676	TA-11R-2*	5013
28" x 20" x 14"		TA-11G*	2648	TA-11G-2*	4791

\* Only Installed In Tables 30" Wide or Wider

\*\* Bowls Are Turned with 16" Front to Back on 24" Wide Tables

† K-50 Swing Spout Faucet (Double Bowl)

#### FLAT TOP, 1" or 1-1/2" REAR SPLASH

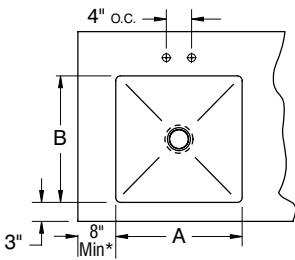

#### 5" REAR SPLASH with 1" RETURN

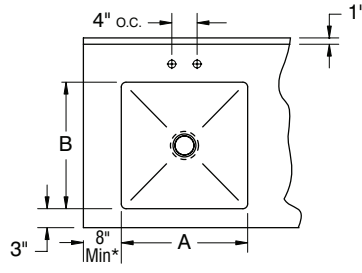

#### 10" REAR SPLASH with 2" RETURN

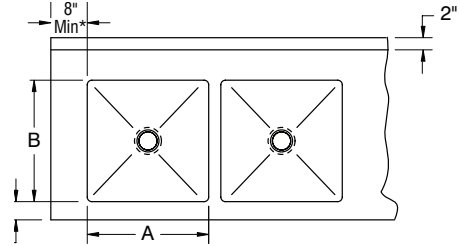

## Modifications

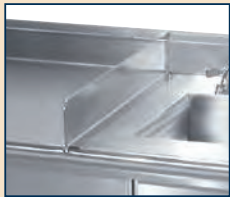

TA-56 \$683  
5" NSF Partition



TA-92 \$249  
Add 12" Apron  
In Front Of Sink



TA-11Z \$65/lin. ft.  
(Return Only)  
Modify 5" Splash To Have 2" Return  
For Splash Mounted Faucet

## Faucets & Accessories

K-2B	Poly-Vance Sink Cutting Board for 14" x 16" Bowls	\$434 ea.
K-2C	Poly-Vance Sink Cutting Board for 16" x 20" Bowls	434 ea.
K-2D	Poly-Vance Sink Cutting Board for 18" x 24" Bowls	434 ea.
K-2E	Poly-Vance Sink Cutting Board for 20" x 20" Bowls	434 ea.
K-2F	Poly-Vance Sink Cutting Board for 24" x 24" Bowls	434 ea.
K-2J	Poly-Vance Sink Cutting Board for 18" x 18" Bowls	434 ea.
K-4	Lever Drain Bracket	105
K-5	Lever Drain	231
K-12	Deck Mounted Soap Dispenser	222
K-15	Lever Drain With Overflow	336
K-50	8" Deck Mounted 4" O.C. Swing Spout Faucet	396
K-50OMIT	Omit Swing Spout	-25
K-52	3 1/2" Spout Deck Mounted 4" O.C. Gooseneck Faucet	341
K-52OMIT	Omit Swing Spout Gooseneck Faucet	-25
K-53	12" Deck Mounted 4" O.C. Swing Spout Faucet	657
K-54	8-1/4" Water Filler Faucet	781

K-54A	12" Water Filler Faucet	\$887
K-55	8 1/2" Spout 4" O.C. Deck Mounted Gooseneck Faucet	657
K-60	4" O.C. Splash Mounted Gooseneck Faucet	853
K-62	X.H.D. 4" O.C. Deck Mounted Gooseneck Faucet	676
K-105	14" Splash Mounted 8" O.C. Faucet	613
K-112	Extra Heavy Duty 12" Splash Mounted Faucets	708
K-316-LU	Wrist Handles For Splash Mounted Faucets	175
K-350	Residential Finish & Packaging	528
K-452	6" x 9" Control Bracket	392
K-453	14" x 16" Control Bracket	420
K-460	Installation Of Disposal Cone w/ 6" x 9" Control Bracket	1171
K-461	Installation Of Collar w/ 6" x 9" Control Bracket	1171
K-470	14" Deep Bowls	254
K-472	Faucet Hole Revision	185
DTA-100	Prerinse Basket for 20" x 20" Bowls	950
DTA-125	Prerinse Basket for 16" x 20" Bowls	830

# REVOLUTIONARY NEW SHD SERIES DRAWER WITH INTEGRAL DRAWER SLIDES

Ship Via UPS

# DRAWERS

## Integral Drawer Slides



**PATENT PENDING**

Shown With 3 Tier Drawer Set Up

- Stainless Steel Front & Sides
- Self Closing Drawer with Noise Control
- Drawer "Safety Stop" Tab
- Removable Stainless Steel Insert

- Units Can Be Stacked to Create Multiple Tier Drawers
- Hardware Included
- NSF Approved

**Drawers Stack With Ease To Create Tier Drawers! Easily Installs In Field**

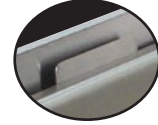

Features a "Safety Stop" Tab

**Insert Size**

<b>SHD-2015</b>	<b>20" x 15" x 5"</b>	<b>\$1208</b>	
Overall Dim. 24 5/8" x 17 1/2"			
<b>SHD-1520</b>	<b>15" x 20" x 5"</b>	<b>\$1208</b>	
Overall Dim. 17 1/2" x 24 5/8"			
<b>SHD-2020</b>	<b>20" x 20" x 5"</b>	<b>\$1286</b>	
Overall Dim. 24 5/8" x 22 11/16"			

### Optional Concealed Side Panels FOR 20"x20" DRAWERS (1 Needed For Each Side)



1 Drawer:  
TA-SHD-1  
**\$235**

2 Drawers:  
TA-SHD-2 **\$296**  
each side

3 Drawers:  
TA-SHD-3  
**\$356**

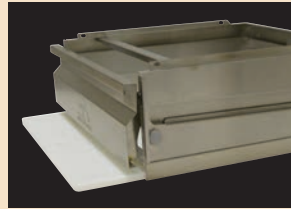

**TA-97SHD \$463**  
Poly Board Storage Bracket  
(Installs In Field. Hardware Included)



Rear View of Multiple Stacked Drawers. Seams Exposed

### SHD Series Modifications & Accessories

TA-2	Concealed Side Panel For 20" x 15" Drawer .....	<b>\$58 ea.</b>
(Add Additional Cost to TA-SHD-1, 2, or 3 Price)		
TA-13	Padlockable Drawer Lock .....	<b>399</b>
TA-14SHD	Drawer Lock For SHD Drawers .....	<b>229</b>
TA-97SHD	Poly Board Storage Brackets For SHD Drawers .....	<b>463</b>
TA-41SHD	5/8" Thick Poly Cutting Board For SHD Drawers .....	<b>224 ea.</b>

### DELUXE SERIES DRAWERS

- Stainless Steel Front
- Ball Bearing Slides
- Removable Insert



Insert Size	All Stainless Steel		All Stainless Steel with Keyed Lock	
	Model #	Price	Model #	Price
20" x 15" x 5"	SS-2015	<b>\$831</b>	SS-2015-DL	<b>\$1027</b>
15 x 20" x 5"	SS-1520	<b>831</b>	SS-1520-DL	<b>1027</b>
20 x 20" x 5"	SS-2020	<b>899</b>	SS-2020-DL	<b>1097</b>

### Deluxe and Budget Drawer Accessories

#### Padlockable Drawer Lock

(Does not include lock. Fits padlocks up to 3/8" dia. lock shaft)

TA-13 ..... **\$399**

#### Keyed Drawer Lock for SS Series Drawers

TA-14 ..... **206**

#### Drawer Adapter/Non Catalog Tables

(specify table width)

TA-90 ..... **96**

### CONCEALED HAND SINK DRAWER

#### Take Back Your Countertop Space!

NSF

- Easily Installs into Existing Advance Tabco Work Tables/Countertops or Integrates into Custom Fabrication
- Overall Size: 22 5/8" W x 19 7/8" L x 19 1/4" H"
- 10" x 14" x 5" Deep Sink Bowl
- Pre-Drilled Holes In Flanges For Easy Mounting
- Integral Drawer Slides For Smooth Operation
- "Safety Stop" Tab
- K-50 Swing Spout Faucet
- 1-1/2" Sink Drain with Strainer Plate
- Drainage Pan with 1-1/2" Drain & Strainer Plate (Drain Pipe & Fittings Included.)

**7-PS-47 \$4004**  
70 lbs. 7 cu. ft. 18 gauge



K-50 Faucet

Drawer Safety Stop Tab

# DRAWERS

## Integral Drawer Slides

All Units on this Page Feature SHD Series Drawers!

## MOBILE DRAWER CABINETS

- Stainless Steel Top Features Countertop Edge
- 5" Swivel Plate Casters (2 with Brakes)
- Available with Three or Four Tier Drawers

Model #	Overall Size L x W x H	# Of Drawers	Drawer Size	Price
MDC-2020	25 1/4" x 25 3/4" x 29 1/2"	3	20" x 20" x 5"	<b>\$5404</b>
MDC-4-2020	25 1/4" x 25 3/4" x 29 1/2"	4	20" x 20" x 5"	<b>6248</b>
MDC-2015	25 1/4" x 21 3/4" x 29 1/2"	3	20" x 15" x 5"	<b>5352</b>
MDC-4-2015	25 1/4" x 21 3/4" x 29 1/2"	4	20" x 15" x 5"	<b>6143</b>



## FACTORY INSTALLED "SHD SERIES" TIER DRAWERS

New 4 Tier Unit Offers More Storage,  
Same Height as 3 Tier Units!

3 or 4 Tiers Available  
Factory Installation Only

Model #	# Of Tiers	Inset Size	Price
TA-38	3 Tiers	20" x 20" x 5"	<b>\$3818</b>
TA-384	4 Tiers	20" x 20" x 5"	<b>4263</b>



TA-38 SHOWN

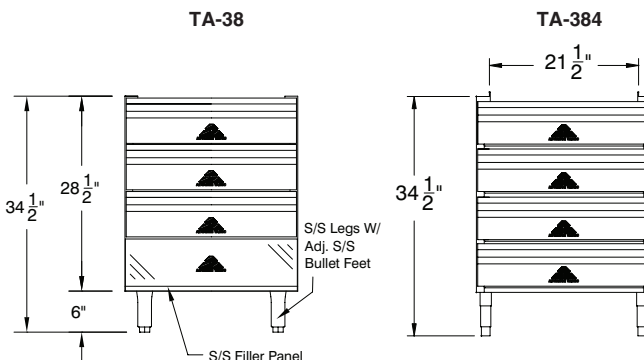

For Tier Drawers on 24" Tables,  
Add TA-380 **\$224** (Drawers will be 20" x 15" x 5")



ADT-3-2020 SERIES SHOWN  
(Table Not Included)

SHIPPED  
FULLY  
ASSEMBLED!



## ADD-A-TIER DRAWERS

Fits Under 24", 30" and 36" Wide  
Open Base Work Tables!

### Features:

- Units Come Fully Assembled!
- Includes 2 or 3 SHD-2020 Series Drawers Stacked with 2 TA-SHD Series Concealed Side Panels (See Photos).
- Hangs From Underside of Open Base Table with Included Hardware.

(See Page 69 for SHD Series Drawer Details)

Includes 2 Concealed Side Panels

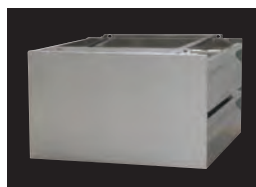

2 Drawer Concealed Panel  
Model ADT-2-2020 Shown



3 Drawer Concealed Panel  
Model ADT-3-2020 Shown



Rear View of Stacked Drawers  
Drawer Seams Exposed

Model #	Overall Size L x W x H	# Of Drawers	Drawer Size	Price
ADT-2-2020	23" x 23" x 14"	2	20" x 20" x 5"	<b>\$3165</b>
ADT-3-2020	23" x 23" x 21"	3	20" x 20" x 5"	<b>3284</b>
ADT-3-2015	23" x 18" x 21"	3	20" x 15" x 5"	<b>3127</b>

### Optional Drawer Locks

TA-13	Padlockable Drawer Lock .....	<b>399</b>
TA-14SHD	Drawer Lock For SHD Drawers .....	<b>229</b>

## WORK TABLE CASTERS



### Standard Casters

Legs Cut To Maintains Standard 35-1/2" Working Height  
200 lbs. Load Capacity Per Caster

**When Used w/ Stainless Steel Legs**

TA-25S-4 **\$624/set of 4** (Two with Brakes)

TA-25S-6 **\$942/set of 6** (Two with Brakes)

**When Used w/ Galvanized Legs**

TA-25G-4 **\$624/set of 4** (Two with Brakes)

TA-25G-6 **\$942/set of 6** (Two with Brakes)

### Casters For Special Height Tables (TA-33) and Open Base Tables (T Series)

TA-25 **\$624/set of 4**  
(Two with Brakes)

TA-25A **\$942/set of 6**  
(Two with Brakes)

200 lbs. Load Capacity Per Caster



### Single Replacement Casters

Available With Or Without Brake (Legs Not Included)

200 lbs. Load Capacity Per Caster

TA-25R **\$114 ea.**  
(No Brake)

TA-25RB **\$140 ea.**  
(With Brake)

#### Optional Standard Caster Upgrades:

TA-25B **\$298/set**

For brakes on all wheels (Standard Casters) - Add price to the following models: TA-25, TA-25A, TA-25S-4, TA-25S-6, TA-25G-4, TA-25G-6

TA-25C **\$53/Per Caster**

Upgrade Standard Caster with Heavy Duty Urethane Wheels (Per Caster)

TA-25C-4 **\$675/set**

Set of 4 Casters with TA-25C upgrade (XHD, non-marking) for 1-5/8" dia. OD table legs. 2 with brakes.



## EQUIPMENT STAND CASTERS



### Standard Casters

5" Urethane Wheels.  
Maintains the Standard 24" Working Height

200 lbs. Load Capacity Per Caster

**w/ Stainless Steel Legs**

TA-25ES **\$624/set of 4** (Two with Brakes)

**w/ Galvanized Legs**

TA-25EG **\$624/set of 4** (Two with Brakes)

### HEAVY DUTY Casters

5" Urethane Wheels

400 lbs. Load Capacity Per Caster



TA-255 **\$831** Super Heavy Duty  
Set of 4 (Two with Brakes)

TA-256 **\$1099** Super Heavy Duty  
Set of 6 (Two with Brakes)

### Enclosed Base Table Casters

Easy Bolt-On Style



TA-255P **\$981** Set of 4 (Two with Brakes)

TA-255AP **\$1428** Set of 6 (Two with Brakes)

300 lbs. Load Capacity Per Caster

For brakes on all wheels (Enclosed Base Casters) -  
Add price to models: TA-255P or TA-255AP

TA-255PB **\$470**

#### Optional Equipment Stand Caster Upgrade:

TA-255B **\$406** For brakes on all wheels (Equipment Casters) - Add price to any of the following models:  
TA-255, TA-256, TA-25ES, TA-25EG

## MID-SHELF & UNDERSHELVES



Shelf Capacity  
20 lbs./sq. ft.



### Stainless Steel

### Galvanized

Length	Stainless Steel			Galvanized								
	24" Wide	Price	30" Wide	Price	36" Wide	Price						
2'	US-24-24	<b>\$497</b>	US-30-24	<b>\$562</b>	NOT AVAILABLE	UG-24-24	<b>\$284</b>	UG-30-24	<b>\$335</b>	NOT AVAILABLE		
30"	US-24-30	<b>562</b>	US-30-30	<b>620</b>	US-36-30	<b>\$711</b>	UG-24-30	<b>335</b>	UG-30-30	<b>343</b>	UG-36-30	<b>\$351</b>
3'	US-24-36	<b>585</b>	US-30-36	<b>711</b>	US-36-36	<b>855</b>	UG-24-36	<b>356</b>	UG-30-36	<b>351</b>	UG-36-36	<b>360</b>
4'	US-24-48	<b>659</b>	US-30-48	<b>801</b>	US-36-48	<b>912</b>	UG-24-48	<b>364</b>	UG-30-48	<b>374</b>	UG-36-48	<b>377</b>
5'	US-24-60	<b>763</b>	US-30-60	<b>868</b>	US-36-60	<b>1028</b>	UG-24-60	<b>374</b>	UG-30-60	<b>389</b>	UG-36-60	<b>407</b>
6'	US-24-72	<b>861</b>	US-30-72	<b>988</b>	US-36-72	<b>1212</b>	UG-24-72	<b>377</b>	UG-30-72	<b>407</b>	UG-36-72	<b>417</b>
7'	US-24-84	<b>979</b>	US-30-84	<b>1061</b>	US-36-84	<b>1282</b>	UG-24-84	<b>389</b>	UG-30-84	<b>417</b>	UG-36-84	<b>434</b>
8'	US-24-96	<b>1061</b>	US-30-96	<b>1209</b>	US-36-96	<b>1395</b>	UG-24-96	<b>407</b>	UG-30-96	<b>424</b>	UG-36-96	<b>470</b>
9'	US-24-108	<b>1104</b>	US-30-108	<b>1384</b>	US-36-108	<b>1664</b>	UG-24-108	<b>424</b>	UG-30-108	<b>486</b>	UG-36-108	<b>505</b>
10'	US-24-120	<b>1162</b>	US-30-120	<b>1442</b>	US-36-120	<b>1723</b>	UG-24-120	<b>460</b>	UG-30-120	<b>519</b>	UG-36-120	<b>536</b>
11'	US-24-132	<b>1445</b>	US-30-132	<b>1702</b>	US-36-132	<b>1901</b>	UG-24-132	<b>510</b>	UG-30-132	<b>559</b>	UG-36-132	<b>578</b>
12'	US-24-144	<b>1488</b>	US-30-144	<b>1758</b>	US-36-144	<b>2006</b>	UG-24-144	<b>573</b>	UG-30-144	<b>623</b>	UG-36-144	<b>638</b>

TA-94 **\$79 lin. ft.**  
16 ga. S/S 304 Series Upgrade for any shelf

TA-9 **\$62 lin. ft.**  
1-1/2" Turn-Up for Undershelves

## MULTI-USE FOOD SHIELDS

Protected By: U.S. Patent No. 11,129,484



**Quickly Converts From Cafeteria Style To Self-Serve Style**

### With Stainless Steel Shelf

18" Standard Shelf Height (Top of Table to Top of Shelf). 24" Wide Shelving Also Available



DSG-12S-48 Glass Positioned For Self-Serve Style

DSG-12S-48 Glass Positioned For Cafeteria Style

- Bottom front glass locks in place at 3 fixed positions
- Entire glass front rotates for easy cleaning
- Stainless Steel 1" diameter Posts.
- Includes Two 18" Wide Glass Side Panels
- 1/4" Thick Heat-Tempered Glass Side Panels
- 3/8" Thick Heat-Tempered Glass Fronts
- Stainless Steel Top Shelf (DSG "S" Series)
- 3/8" Glass Top Shelf (DSG "G" Series)

<sup>†</sup>Requires a Single Pair of Center Legs (Factory Print Included)

<sup>††</sup>Requires Two Pair of Center Legs (Factory Print Included)

12" WIDE	Price	Approx. Wt.	15" WIDE	Price	Approx. Wt.	18" WIDE	Price	Approx. Wt.	Approx. Cubes
DSG-12S-36	\$6723	131 lbs.	DSG-15S-36	\$7539	133 lbs.	DSG-18S-36	\$7861	136 lbs.	14
DSG-12S-48	6955	166 lbs.	DSG-15S-48	7708	169 lbs.	DSG-18S-48	8030	173 lbs.	18
DSG-12S-60	7912	191 lbs.	DSG-15S-60	8282	196 lbs.	DSG-18S-60	8604	199 lbs.	22
DSG-12S-72	8225	237 lbs.	DSG-15S-72	8701	245 lbs.	DSG-18S-72	9226	250 lbs.	26
DSG-12S-84 <sup>†</sup>	8510	276 lbs.	DSG-15S-84 <sup>†</sup>	9096	279 lbs.	DSG-18S-84 <sup>†</sup>	9421	286 lbs.	30
DSG-12S-96 <sup>†</sup>	9244	312 lbs.	DSG-15S-96 <sup>†</sup>	9726	314 lbs.	DSG-18S-96 <sup>†</sup>	10046	323 lbs.	34
DSG-12S-108 <sup>†</sup>	9510	346 lbs.	DSG-15S-108 <sup>†</sup>	10242	353 lbs.	DSG-18S-108 <sup>†</sup>	10564	359 lbs.	38
DSG-12S-120 <sup>†</sup>	9787	382 lbs.	DSG-15S-120 <sup>†</sup>	10555	389 lbs.	DSG-18S-120 <sup>†</sup>	10856	397 lbs.	42
DSG-12S-132 <sup>†</sup>	10030	420 lbs.	DSG-15S-132 <sup>†</sup>	10791	428 lbs.	DSG-18S-132 <sup>†</sup>	11114	437 lbs.	46
DSG-12S-144 <sup>††</sup>	10498	455 lbs.	DSG-15S-144 <sup>††</sup>	10998	465 lbs.	DSG-18S-144 <sup>††</sup>	11321	473 lbs.	50

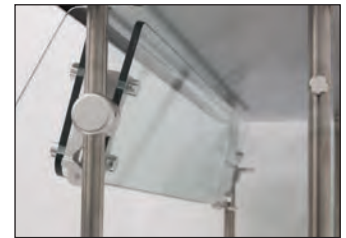

Bottom Glass Flips All The Way Up To Become A Self-Serve Unit



Bottom Glass Can be Used As a Shelf



Easy To Use Mechanism For Changing Front Glass Positions



Entire Glass Shield Rotates For Easy Cleaning

### With 3/8" Glass Top

18" Standard Shelf Height (Top of Table to Top of Glass Shelf)



DSG-12G-12-72 Glass Positioned For Self-Serve Style

DSG-12G-72 Glass Positioned For Cafeteria Style

12" WIDE	Price	Approx. Wt.	15" WIDE	Price	Approx. Wt.	18" WIDE	Price	Approx. Wt.	Approx. Cubes
DSG-12G-36	\$8017	139 lbs.	DSG-15G-36	\$8896	143 lbs.	DSG-18G-36	\$9540	147 lbs.	18
DSG-12G-48	8246	179 lbs.	DSG-15G-48	9063	182 lbs.	DSG-18G-48	9710	187 lbs.	23
DSG-12G-60	9202	228 lbs.	DSG-15G-60	9637	235 lbs.	DSG-18G-60	10267	242 lbs.	29
DSG-12G-72	9519	279 lbs.	DSG-15G-72	10059	266 lbs.	DSG-18G-72	10707	275 lbs.	34
DSG-12G-84 <sup>†</sup>	9809	298 lbs.	DSG-15G-84 <sup>†</sup>	10453	305 lbs.	DSG-18G-84 <sup>†</sup>	11096	316 lbs.	39
DSG-12G-96 <sup>†</sup>	10535	330 lbs.	DSG-15G-96 <sup>†</sup>	11080	346 lbs.	DSG-18G-96 <sup>†</sup>	11727	357 lbs.	44
DSG-12G-108 <sup>†</sup>	10801	373 lbs.	DSG-15G-108 <sup>†</sup>	11597	383 lbs.	DSG-18G-108 <sup>†</sup>	12243	397 lbs.	49
DSG-12G-120 <sup>†</sup>	11079	412 lbs.	DSG-15G-120 <sup>†</sup>	11888	424 lbs.	DSG-18G-120 <sup>†</sup>	12535	439 lbs.	55
DSG-12G-132 <sup>†</sup>	11321	453 lbs.	DSG-15G-132 <sup>†</sup>	12149	467 lbs.	DSG-18G-132 <sup>†</sup>	12794	483 lbs.	60
DSG-12G-144 <sup>††</sup>	11789	495 lbs.	DSG-15G-144 <sup>††</sup>	12353	511 lbs.	DSG-18G-144 <sup>††</sup>	13037	528 lbs.	65

\*Requires a Single Pair of Center Legs (Factory Print Included)

†Requires Two Pair of Center Legs (Factory Print Included)

\*3/8" Thick Heat-Tempered Glass Required For Front Glass

**Exclusive Features Of NSG/NDSG/NSGC Sleek Shields:**

- Front glass locks in place at 15° intervals
- Stainless Steel 1" diameter Posts
- Includes Two 1/4" Heat-Tempered Side Glass
- 1/4" or 3/8" Thick Heat-Tempered Glass Front Panels (See Chart For "\*" Symbol)
- Shelves have two rolled edges on front & rear and square edges on left & right sides

# FOOD SHIELDS

## Adjustable Food Shields

### Sleek Shields™

Protected By: Patent No. US 9,010,883 B2

## With Stainless Steel Shelf

18" Standard Shelf Height (Top of Table to Top of Shelf) • 24" Wide Shelving Also Available

### SELF SERVE STYLE

12" WIDE	Price	Approx. Wt.	15" WIDE	Price	Approx. Wt.	18" WIDE	Price	Approx. Wt.	Approx. Cubes
NSG-12-36	\$4484	120 lbs.	NSG-15-36	\$4895	122 lbs.	NSG-18-36	\$6077	124 lbs.	18
NSG-12-48	4610	152 lbs.	NSG-15-48	5105	155 lbs.	NSG-18-48	6093	159 lbs.	23
NSG-12-60*	5624	191 lbs.	NSG-15-60*	5678	194 lbs.	NSG-18-60*	6712	198 lbs.	29
NSG-12-72*	5819	221 lbs.	NSG-15-72*	6098	228 lbs.	NSG-18-72*	7134	230 lbs.	34
NSG-12-84†	6103	254 lbs.	NSG-15-84†	6491	260 lbs.	NSG-18-84†	7525	265 lbs.	39
NSG-12-96†	6833	288 lbs.	NSG-15-96†	7118	293 lbs.	NSG-18-96†	8151	299 lbs.	44
NSG-12-108†*	7101	314 lbs.	NSG-15-108†*	7632	321 lbs.	NSG-18-108†*	8666	327 lbs.	49
NSG-12-120†*	7376	363 lbs.	NSG-15-120†*	7925	370 lbs.	NSG-18-120†*	8959	376 lbs.	55
NSG-12-132†*	7620	398 lbs.	NSG-15-132†*	8187	406 lbs.	NSG-18-132†*	9221	413 lbs.	60
NSG-12-144††	8087	422 lbs.	NSG-15-144††	8396	430 lbs.	NSG-18-144††	9429	439 lbs.	65

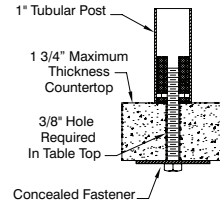

Includes Standard Concealed Mounting Hardware  
(Access To Underside Of Counter Required)

Sleek Shields™ w/ Stainless Steel or Glass Shelf Can Be Added To All Hot/Cold Food Tables On Pages 128-137 See Sleek Shield Models For Food Tables On Page 138



### SELF SERVE STYLE - DOUBLE TIER

12" WIDE	Price	Approx. Wt.	15" WIDE	Price	Approx. Wt.	18" WIDE	Price	Approx. Wt.	Approx. Cubes
NDSG-12-36	\$7080	155 lbs.	NDSG-15-36	\$7040	168 lbs.	NDSG-18-36	\$8427	166 lbs.	26
NDSG-12-48	7384	194 lbs.	NDSG-15-48	7238	209 lbs.	NDSG-18-48	8631	206 lbs.	34
NDSG-12-60*	8341	243 lbs.	NDSG-15-60*	7785	263 lbs.	NDSG-18-60*	9210	258 lbs.	41
NDSG-12-72*	8657	277 lbs.	NDSG-15-72*	8185	305 lbs.	NDSG-18-72*	9633	308 lbs.	49
NDSG-12-84†	8947	324 lbs.	NDSG-15-84†	8560	347 lbs.	NDSG-18-84†	10021	344 lbs.	56
NDSG-12-96†	9677	353 lbs.	NDSG-15-96†	9158	383 lbs.	NDSG-18-96†	10651	376 lbs.	64
NDSG-12-108†*	9941	399 lbs.	NDSG-15-108†*	9648	425 lbs.	NDSG-18-108†*	11159	411 lbs.	71
NDSG-12-120†*	10220	443 lbs.	NDSG-15-120†*	9929	467 lbs.	NDSG-18-120†*	11458	457 lbs.	79
NDSG-12-132†*	10461	483 lbs.	NDSG-15-132†*	10174	521 lbs.	NDSG-18-132†*	11719	503 lbs.	86
NDSG-12-144††	10595	513 lbs.	NDSG-15-144††	10372	573 lbs.	NDSG-18-144††	12065	546 lbs.	94



10-1/2" Standard Glass Opening (Maximum 13")  
From Table To Bottom Of Glass.

### CAFETERIA STYLE

12" WIDE	Price	Approx. Wt.	15" WIDE	Price	Approx. Wt.	18" WIDE	Price	Approx. Wt.	Approx. Wt.
NSGC-12-36	\$5001	125 lbs.	NSGC-15-36	\$5818	128 lbs.	NSGC-18-36	\$6140	130 lbs.	18
NSGC-12-48	5234	160 lbs.	NSGC-15-48	5986	163 lbs.	NSGC-18-48	6308	167 lbs.	23
NSGC-12-60*	6189	185 lbs.	NSGC-15-60*	6561	190 lbs.	NSGC-18-60*	6884	193 lbs.	29
NSGC-12-72*	6503	231 lbs.	NSGC-15-72*	6983	239 lbs.	NSGC-18-72*	7504	244 lbs.	34
NSGC-12-84†	6790	270 lbs.	NSGC-15-84†	7373	274 lbs.	NSGC-18-84†	7699	281 lbs.	39
NSGC-12-96†	7522	306 lbs.	NSGC-15-96†	8005	308 lbs.	NSGC-18-96†	8323	317 lbs.	44
NSGC-12-108†*	7789	340 lbs.	NSGC-15-108†*	8519	347 lbs.	NSGC-18-108†*	8840	353 lbs.	49
NSGC-12-120†*	8064	376 lbs.	NSGC-15-120†*	8833	383 lbs.	NSGC-18-120†*	9133	391 lbs.	55
NSGC-12-132†*	8309	414 lbs.	NSGC-15-132†*	9070	422 lbs.	NSGC-18-132†*	9393	431 lbs.	60
NSGC-12-144††	8775	450 lbs.	NSGC-15-144††	9277	574 lbs.	NSGC-18-144††	9600	467 lbs.	65



1-1/2" Standard Glass Opening (Maximum 1-1/2")  
From Table To Bottom Of Glass.

**CUSTOM UNITS & SIZES AVAILABLE ON ALL FOOD SHIELDS**  
Food Shield Prices May Change Due To Customer Specifications & Design



All Food Shields are a non-stock special order items & may not be canceled once ordered.

# FOOD SHIELDS

## Adjustable Food Shields

# Sleek Shields™

Protected By: Patent No. US 9,010,883 B2

## With Glass Top

3/8" Thick Heat-Tempered Glass Top

- \*Requires a Single Pair of Center Legs (Factory Print Included)
- \*\*Requires Two Pair of Center Legs (Factory Print Included)
- \*3/8" Thick Heat-Tempered Glass Required For Front Glass

### Exclusive Features Of GSG/GSGC/NSGD Sleek Shields:

- Front glass locks in place at 15° intervals
- Stainless Steel 1" diameter Posts
- Includes Two 1/4" Heat-Tempered Side Glass
- 1/4" or 3/8" Thick Heat-Tempered Glass Front Panels (See Chart For "\*" Symbol)
- Glass Top Features 3/8" Heat-Tempered Glass Top

## SELF SERVE STYLE

12" WIDE	Price	Approx. Wt.	15" WIDE	Price	Approx. Wt.	18" WIDE	Price	Approx. Wt.	Approx. Cubes
GSG-12-36	\$5038	127 lbs.	GSG-15-36	\$5754	146 lbs.	GSG-18-36	\$6402	133 lbs.	18
GSG-12-48	5254	162 lbs.	GSG-15-48	5964	187 lbs.	GSG-18-48	6610	173 lbs.	23
GSG-12-60*	6227	202 lbs.	GSG-15-60*	6537	234 lbs.	GSG-18-60*	7184	216 lbs.	29
GSG-12-72†	6419	238 lbs.	GSG-15-72†	6960	274 lbs.	GSG-18-72†	7604	253 lbs.	34
GSG-12-84†	6706	274 lbs.	GSG-15-84†	7354	316 lbs.	GSG-18-84†	8000	292 lbs.	39
GSG-12-96†	7439	309 lbs.	GSG-15-96†	7937	357 lbs.	GSG-18-96†	8627	330 lbs.	44
GSG-12-108†*	7700	338 lbs.	GSG-15-108†*	8497	392 lbs.	GSG-18-108†*	9119	362 lbs.	49
GSG-12-120†*	7978	391 lbs.	GSG-15-120†*	8787	451 lbs.	GSG-18-120†*	9432	417 lbs.	55
GSG-12-132†*	8223	427 lbs.	GSG-15-132†*	9076	495 lbs.	GSG-18-132†*	9695	457 lbs.	60
GSG-12-144††	8690	455 lbs.	GSG-15-144††	9256	529 lbs.	GSG-18-144††	9903	489 lbs.	65



10-1/2" Standard Glass Opening (Maximum 13")  
From Table To Bottom Of Glass.  
Max. Load For Top Glass Is 100 Lbs. Even Dist. Wt.

## CAFETERIA STYLE

12" WIDE	Price	Approx. Wt.	15" WIDE	Price	Approx. Wt.	18" WIDE	Price	Approx. Wt.	Approx. Cubes
GSGC-12-36	\$5605	133 lbs.	GSGC-15-36	\$6487	137 lbs.	GSGC-18-36	\$7133	141 lbs.	18
GSGC-12-48	5833	173 lbs.	GSGC-15-48	6653	176 lbs.	GSGC-18-48	7300	182 lbs.	23
GSGC-12-60*	6790	222 lbs.	GSGC-15-60*	7227	229 lbs.	GSGC-18-60*	7856	236 lbs.	29
GSGC-12-72†	7111	274 lbs.	GSGC-15-72†	7649	260 lbs.	GSGC-18-72†	8297	269 lbs.	34
GSGC-12-84†	7398	292 lbs.	GSGC-15-84†	8042	300 lbs.	GSGC-18-84†	8687	311 lbs.	39
GSGC-12-96†	8127	330 lbs.	GSGC-15-96†	8669	340 lbs.	GSGC-18-96†	9317	351 lbs.	44
GSGC-12-108†*	8394	367 lbs.	GSGC-15-108†*	9185	377 lbs.	GSGC-18-108†*	9830	391 lbs.	49
GSGC-12-120†*	8666	406 lbs.	GSGC-15-120†*	9478	419 lbs.	GSGC-18-120†*	10124	434 lbs.	55
GSGC-12-132†*	8911	447 lbs.	GSGC-15-132†*	9738	461 lbs.	GSGC-18-132†*	10382	477 lbs.	60
GSGC-12-144††	9379	489 lbs.	GSGC-15-144††	9944	505 lbs.	GSGC-18-144††	10627	522 lbs.	65

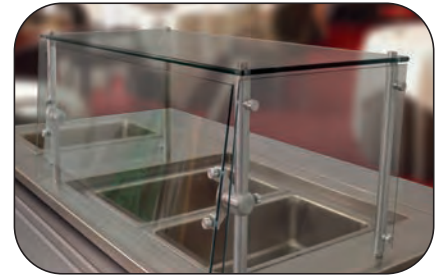

1-1/2" Standard Glass Opening (Maximum 1-1/2")  
From Table To Bottom Of Glass.  
Max. Load For Top Glass Is 100 Lbs. Even Dist. Wt.

## SELF SERVE STYLE - DOUBLE SIDED

w/ Stainless Steel Shelf			w/ Glass Top			Approx. Cubes
Model #	Price	Approx. Wt.	Model #	Price	Approx. Wt.	
NSGD-40-36	\$8218	339 lbs.	GSGD-40-36	\$8401	368 lbs.	32
NSGD-40-48	8439	391 lbs.	GSGD-40-48	8624	437 lbs.	42
NSGD-40-60*	9410	451 lbs.	GSGD-40-60*	9594	509 lbs.	51
NSGD-40-72†	9600	518 lbs.	GSGD-40-72†	9785	592 lbs.	61
NSGD-40-84†	9888	604 lbs.	GSGD-40-84†	10073	660 lbs.	70
NSGD-40-96†	10619	667 lbs.	GSGD-40-96†	10803	729 lbs.	79
NSGD-40-108†*	10883	725 lbs.	GSGD-40-108†*	11484	798 lbs.	89
NSGD-40-120†*	11157	782 lbs.	GSGD-40-120†*	11898	868 lbs.	98
NSGD-40-132†*	11403	840 lbs.	GSGD-40-132†*	12139	932 lbs.	107
NSGD-40-144††	11873	909 lbs.	GSGD-40-144††	12408	1001 lbs.	117



GSGD Series Shown  
10-1/2" Standard Glass Opening (Maximum 13")  
From Table To Bottom Of Glass.  
Max. Load For Top Glass Is 100 Lbs. Even Dist. Wt.



Sleek Shields™ w/ Stainless Steel or Glass Shelf Can Be Added To Hot/Cold Food Tables With 2, 3 or 4 Wells, Listed On Pages 128-137  
See Sleek Shield Models For Food Tables On Page 142



All Food Shields are a non-stock special order items & may not be canceled once ordered.



For Accessories & Modifications Available - See Page 76

# FOOD SHIELDS

## Adjustable & Fixed Front Food Shields

### Sleek Shields™ SELF SERVE FOOD SHIELD

14 3/4" Standard Front Glass

Glass Clearance is 10" From Table to Bottom of Glass

Single Front Glass				Dual Front Glass (Includes Center Post)			
Model #	Price	Approx. Wt.	Approx. Cubes	Model #	Price	Approx. Wt.	Approx. Cubes
GS-36	\$5604	136	20	GS-84	\$7280	280	40
GS-48	5784	171	26	GS-96	8600	317	44
GS-60	5962	266	31	GS-120	9006	358	48
GS-66	6199	238	34	GS-132	9469	396	52
GS-72	7049	243	37	GS-144	9739	434	56



FEATURING  
CHAMBER LOCK™  
ROTATION SYSTEM  
Protected By: Patent No. US  
9,010,883 B2

- 3/8" Thick Heat-Tempered Glass Front
- 2 - 21 7/8" Wide x 22" High,  
1/4" Thick Heat-Tempered Side Glass
- 1" Stainless Steel Tubing Posts

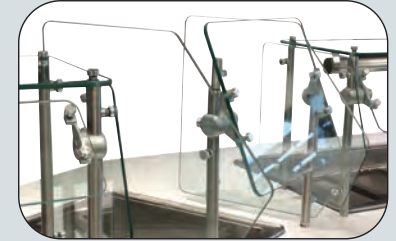

### FIXED FRONT GLASS TOP FOOD SHIELDS

Includes Front & Side Glass • 15" Wide Glass Top Also Available

- 3/8" Thick Heat-Tempered Top Glass
- 1" Stainless Steel Round Tubing
- 1/4" Thick Heat-Tempered Front Glass\*
- Includes Standard Concealed Mounting Hardware  
(Access To Underside Of Counter Required)
- Two 1/4" Thick Heat-Tempered Glass Side Panels



STFS-12-36 Series shown



STFC-12-36 Series shown

Self-Serve Style 8" Standard Front Glass Height						Cafeteria Style 18" Standard Front Glass Height							
L	12" WIDE	Price	Wt.	18" WIDE	Price	Wt.	12" WIDE	Price	Wt.	18" WIDE	Price	Wt.	Cubes
36"	STFS-12-36	\$3498	127 lbs.	STFS-18-36	\$4862	133 lbs.	STFC-12-36	\$4065	133 lbs.	STFC-18-36	\$5592	141 lbs.	18
48"	STFS-12-48	3716	162 lbs.	STFS-18-48	5070	173 lbs.	STFC-12-48	4293	173 lbs.	STFC-18-48	5760	182 lbs.	23
60"	STFS-12-60*	4687	202 lbs.	STFS-18-60*	5645	216 lbs.	STFC-12-60*	5251	222 lbs.	STFC-18-60*	6317	236 lbs.	29
72"	STFS-12-72*	4878	238 lbs.	STFS-18-72*	6066	253 lbs.	STFC-12-72*	5570	274 lbs.	STFC-18-72*	6757	269 lbs.	34
84"	STFS-12-84†	5166	274 lbs.	STFS-18-84†	6459	292 lbs.	STFC-12-84†	5858	292 lbs.	STFC-18-84†	7147	311 lbs.	39
96"	STFS-12-96†	5900	309 lbs.	STFS-18-96†	7086	330 lbs.	STFC-12-96†	6586	330 lbs.	STFC-18-96†	7775	351 lbs.	44
108"	STFS-12-108*†	6159	338 lbs.	STFS-18-108*†	7579	362 lbs.	STFC-12-108*†	6852	367 lbs.	STFC-18-108*†	8291	391 lbs.	49
120"	STFS-12-120*†	6438	391 lbs.	STFS-18-120*†	7892	417 lbs.	STFC-12-120*†	7126	406 lbs.	STFC-18-120*†	8584	434 lbs.	55
132"	STFS-12-132*†	6683	427 lbs.	STFS-18-132*†	8156	457 lbs.	STFC-12-132*†	7370	447 lbs.	STFC-18-132*†	8842	477 lbs.	60
144"	STFS-12-144††	7149	455 lbs.	STFS-18-144††	8363	489 lbs.	STFC-12-144††	7838	489 lbs.	STFC-18-144††	9088	522 lbs.	65

\*3/8" Thick Heat-Tempered Glass Required For Front † Requires a single pair of center legs †† Requires two pair of center legs

### 45° ANGLED FIXED FRONT FOOD SHIELDS

#### Self-Serve Style

w/ Angled Top & Side Glass

Model #	Price	Approx. Wt.	Approx. Cubes
AFS-36	\$4963	130 lbs.	6
AFS-48	5649	164 lbs.	8
AFS-60*	6198	207 lbs.	10



Shown With Black Powder Coating

- 1/4" Thick Heat-Tempered Front Glass
- 1/4" Thick Side Glass
- 1" Stainless Steel Tubing with End Caps
- Includes Standard Concealed Mounting Hardware  
(Access To Underside Of Counter Required)

#### Cafeteria Style

w/ Angled Top, Front & Side Glass

Model #	Price	Approx. Wt.	Approx. Cubes
AFC-36	\$5874	143 lbs.	6
AFC-48	6547	178 lbs.	8
AFC-60*	6722	235 lbs.	10



### FIXED FRONT VERTICAL FOOD SHIELDS



For Enclosed Base Table Options See Pages 53

- 24" Standard Front Glass height
- 1/4" Thick Heat-Tempered Glass
- Two 18" Wide Glass Side Panels
- 1" Stainless Steel Tubing with End Caps  
(1 5/8" Tubing Also Available)
- Includes Standard Concealed Mounting Hardware  
(Access To Underside Of Counter Required)
- NSF Requires 60" Minimum Height Above Finished Floor
- NSF Requires 6" Maximum Height From Top of Table to Bottom of Glass

Custom Food Shield Sizes Available  
Call Our Smart Fabrication™ Department At  
800-645-3166

Model #	Price	Approx. Wt.	Approx. Cubes
SGCC-36	\$6686	139 lbs.	9
SGCC-48	7385	194 lbs.	11
SGCC-60*	8323	219 lbs.	13
SGCC-72	10540	240 lbs.	15
SGCC-84	10453	271 lbs.	17
SGCC-96	10998	311 lbs.	19
SGCC-108*	11886	357 lbs.	22
SGCC-120*	13024	412 lbs.	25
SGCC-132	13845	451 lbs.	26
SGCC-144	14837	518 lbs.	27

\*3/8" Thick Heat-Tempered Glass Required For Front

## SLEEK SHIELDS™ ACCESSORIES & MODIFICATIONS

### LED Display Lighting

Factory Installed

- Aluminum Rail with Shatter-Proof Optics
- Standard Natural Aluminum Finish. Available in White or Black
- Includes Class 2 Low Voltage Power Supply-120V-277V
- High Impact Resistant Mounting Clips



**FACTORY INSTALLED ONLY**  
Includes Installation Charge

L	S/S Shelf Mounted		Glass Top Mounted	
	Model #	Price	Model #	Price
1'	LED-S-12	\$575	LED-G-12	\$843
2'	LED-S-24	693	LED-G-24	991
3'	LED-S-36	799	LED-G-36	1097
4'	LED-S-48	891	LED-G-48	1196
5'	LED-S-60	991	LED-G-60	1262
6'	LED-S-72	1130	LED-G-72	1398

Shelves Require 6" Clearance  
On Both Sides  
To Fit Above Led Lighting.

PRINT REQUIRED  
FOR PROPER LED LOCATION

### Heat Lamp Mounting Provisions

Customers To Supply Heat Lamp

All Food Shields With Glass Tops Require  
**Factory Installation Only**

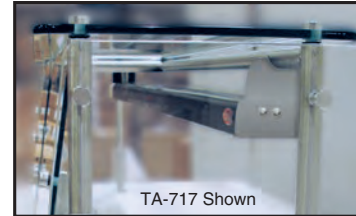

**FACTORY INSTALLED**

**TA-717 \$293 /lin. ft.**

MINIMUM OF 3 FEET REQUIRED.  
MUST ORDER SAME LENGTH AS  
FOOD SHIELD.

- Welded Tubular Stainless Steel Posts
- Chase-Way for Concealing Wiring
- Pre-Wiring Available
- Print Required For Proper Installation

**INSTALLED BY OTHERS**

(Provision for mounting to Stainless Steel Shelves only)

**TA-71 \$239 ea.**

### Revolutionary Sleek Shield™ Horizontal Swivel Bracket

- Bracket Connects Multiple Sleek Shields™ And Swivels Freely for Custom Line Up
- Easily Adjusts In Field Without Tools
- Factory Installed Only

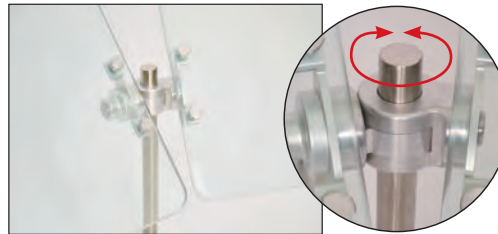

**SG-S \$1850**  
Per Section



**SG-1**

#### SURFACE MOUNTING BRACKET

(For 1" Posts)  
**SG-1 \$172 ea.**

#### CANTILEVER SUPPORT BRACKET UPGRADE

(Omits Front or Rear Support Leg To Equipment in Counter)

**SG-C \$639** per leg



**SG-PC Shown**

#### CUSTOM COLORS SG-AN Call For Pricing

Color Anodizing For Sleek Shields™ (For Aluminum Components)

#### SG-PC Call For Pricing

Powder Coating For Sleek Shields™ (For Stainless Steel Components)

REDUCE LENGTH OR WIDTH OF SHELF  
Start With Next Largest Size Then Add To Model Number  
**TA-60 N/C**

SPECIAL HEIGHT FOR FOOD SHIELDS  
Please Specify Height  
**TA-33F \$74**

## PORTABLE FOOD SHIELDS

- 15" Front Panel
- 1/4" Thick Thermoplastic Polymer Sneeze Guard
- 1" Stainless Steel Posts
- 1-1/2" Wide x 14-1/2" Front to Back Black Support Base
- Shipped K.D.

Length	Model #	Price	Approx. Wt.	Approx. Cubes
24"	PFS-24B	\$2657	11 lbs.	5
36"	PFS-36B	2915	12 lbs.	6
48"	PFS-48B	3375	15 lbs.	18
60"	PFS-60B	3796	18 lbs.	8
72"	PFS-72B	4142	21 lbs.	9

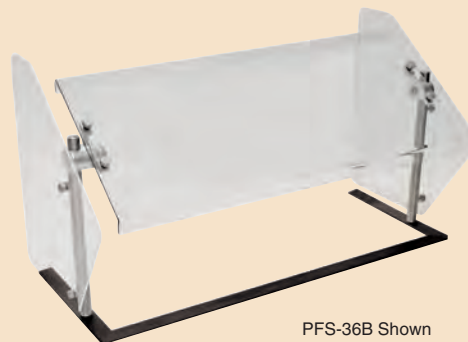

#### OPTIONAL 18" WIDE SIDE PANELS

18" x 20" x 1/4" Acrylic Side Panels  
Factory Installed Only

**PFS-SP \$1205 /set of 2**

Approx. 5 lbs.

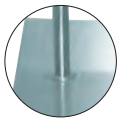

Shelves Mount to Underside of Table with Single Expansion Bolt to Maximize Space



# SHELVING

## Stainless Steel Shelving

### TABLE MOUNTED ALL STAINLESS STEEL SHELVING



SINGLE DECK SHELVING					
Ft.	12" WIDE	Price	15" WIDE†	Price	Approx. Wt. / Approx. Cubes
3'	OTS-12-36	\$1110	OTS-15-36	\$1328	24 lbs. / 2
4'	OTS-12-48	1168	OTS-15-48	1441	25 lbs. / 3
5'	OTS-12-60	1266	OTS-15-60	1625	31 lbs. / 3
6'	OTS-12-72	1348	OTS-15-72	1798	37 lbs. / 4
7'	OTS-12-84	1441	OTS-15-84	1881	43 lbs. / 5
8'	OTS-12-96*	1740	OTS-15-96*	2025	50 lbs. / 5
9'	OTS-12-108*	1848	OTS-15-108*	2412	59 lbs. / 6
10'	OTS-12-120*	1897	OTS-15-120*	2471	68 lbs. / 7
11'	OTS-12-132*	1996	OTS-15-132*	2770	82 lbs. / 7
12'	OTS-12-144*	2056	OTS-15-144*	2832	98 lbs. / 8

\* SHELVES 8' OR LONGER INCLUDE CENTER LEG SUPPORT



DOUBLE DECK SHELVING					
Ft.	12" WIDE	Price	15" WIDE†	Price	Approx. Wt. / Approx. Cubes
3'	ODS-12-36	\$2210	ODS-15-36	\$2391	24 lbs. / 4
4'	ODS-12-48	2273	ODS-15-48	2575	29 lbs. / 5
5'	ODS-12-60	2423	ODS-15-60	2889	35 lbs. / 6
6'	ODS-12-72	2584	ODS-15-72	3168	40 lbs. / 7
7'	ODS-12-84	2768	ODS-15-84	3437	46 lbs. / 8
8'	ODS-12-96*	3300	ODS-15-96*	3844	55 lbs. / 10
9'	ODS-12-108*	3554	ODS-15-108*	4182	60 lbs. / 11
10'	ODS-12-120*	3615	ODS-15-120*	4351	66 lbs. / 12
11'	ODS-12-132*	3860	ODS-15-132*	4587	72 lbs. / 13
12'	ODS-12-144*	3920	ODS-15-144*	4791	78 lbs. / 14

\*8' or longer includes center leg support

For 1" Rear Turn Up, add "R" after model # (Example: OTS-12-60R) • †15" Wide Shelving has 1-5/8" Tubing

### TABLE MOUNTED FULLY ADJUSTABLE SHELVING WITH 14" OR 30" CHROME POSTS

SINGLE DECK SHELVING					DOUBLE DECK SHELVING				
Ft.	12" WIDE	Price	Approx. Wt.	Approx. Cubes	Ft.	12" WIDE	Price	Approx. Wt.	Approx. Cubes
3'	TS-12-36	\$1040	13 lbs.	2	3'	DS-12-36	\$2051	24 lbs.	4
4'	TS-12-48	1104	15 lbs.	3	4'	DS-12-48	2113	29 lbs.	5
5'	TS-12-60	1179	17 lbs.	3	5'	DS-12-60	2274	35 lbs.	6
6'	TS-12-72	1260	20 lbs.	4	6'	DS-12-72	2435	40 lbs.	7
7'	TS-12-84	1346	23 lbs.	5	7'	DS-12-84	2598	46 lbs.	8
8'	TS-12-96*	1641	28 lbs.	5	8'	DS-12-96*	3150	55 lbs.	10
9'	TS-12-108*	1745	30 lbs.	6	9'	DS-12-108*	3416	60 lbs.	11
10'	TS-12-120*	1803	33 lbs.	7	10'	DS-12-120*	3480	66 lbs.	12
11'	TS-12-132*	1909	36 lbs.	7	11'	DS-12-132*	3740	72 lbs.	13
12'	TS-12-144*	1972	39 lbs.	8	12'	DS-12-144*	3796	78 lbs.	14

\*8' or longer includes center leg support

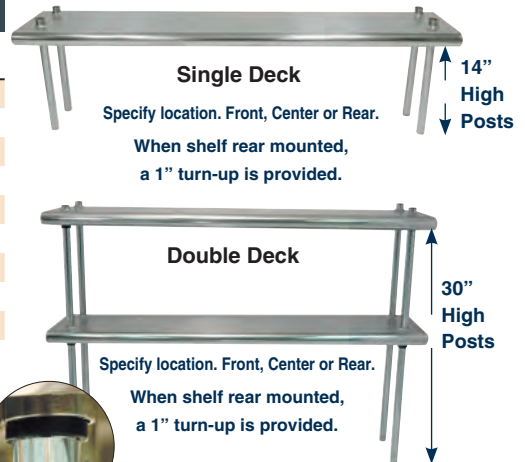

Tapered Split Sleeve Installation & Numbered Posts



For 1" Rear Turn Up, add "R" after model # (Example: TS-12-60R) • For 15" Wide Shelving (w/ 1-5/8" Tubing) Use OTS/ODS Series

### ADJUSTABLE 18" WIDE DOUBLE OVERSHELF WITH 6" OFFSET



Length	Model #	Price	Approx. Wt.	Approx. Cubes
3'	CDS-18-36	\$3900	24 lbs.	4
4'	CDS-18-48	3975	29 lbs.	5
5'	CDS-18-60	4474	35 lbs.	6
6'	CDS-18-72	4571	40 lbs.	7
7'	CDS-18-84	4668	46 lbs.	8
8'	CDS-18-96	4922	55 lbs.	10
9'	CDS-18-108	5215	60 lbs.	11
10'	CDS-18-120	5296	66 lbs.	12
11'	CDS-18-132	5509	72 lbs.	13
12'	CDS-18-144	5567	78 lbs.	14



= Ship Via UPS

## PASS-THRU SHELVING

### Standard Pass-Thru Shelf

- "Hat Channel" Design Allows Shelf To Be Freely Positioned
- Includes Wall Mounting Brackets For Securing Shelf To Desired Position



Pass-Thru shown with Cantilever Brackets

### Pass-Thru Shelf with Overshelf

- 1 CU Series Overshelf welded to a PA Series Pass-Thru shelf
- 1-5/8" Stainless Steel Tubing
- Shipped as Welded Set-Up



Pass-Thru with CU Series Shelf & Cantilever Bracket Shown

**Pre-Wiring Available!**

Contact our Smart Fab Department at [smartfab@advancetabco.com](mailto:smartfab@advancetabco.com)

18" WIDE	Price	24" WIDE	Price	# of Length Brackets
PA-18-24	<b>\$1516</b>	PA-24-24	<b>\$1706</b>	24" 2
PA-18-36	<b>1862</b>	PA-24-36	<b>1873</b>	36" 2
PA-18-48	<b>2025</b>	PA-24-48	<b>2529</b>	48" 2
PA-18-60	<b>2180</b>	PA-24-60	<b>2724</b>	60" 2
PA-18-72	<b>2256</b>	PA-24-72	<b>2918</b>	72" 2
PA-18-84	<b>2335</b>	PA-24-84	<b>3191</b>	84" 3
PA-18-96	<b>2417</b>	PA-24-96	<b>3415</b>	96" 3
PA-18-108	<b>2520</b>	PA-24-108	<b>3431</b>	108" 3
PA-18-120	<b>2566</b>	PA-24-120	<b>3478</b>	120" 3
PA-18-132	<b>2801</b>	PA-24-132	<b>3796</b>	132" 4
PA-18-144	<b>3191</b>	PA-24-144	<b>4073</b>	144" 4

18" WIDE	Price	24" WIDE	Price	# of Length Brackets
PA-18-48-2	<b>\$4164</b>	PA-24-48-2	<b>\$5258</b>	48" 2
PA-18-60-2	<b>4393</b>	PA-24-60-2	<b>5645</b>	60" 2
PA-18-72-2	<b>4549</b>	PA-24-72-2	<b>5964</b>	72" 2
PA-18-84-2	<b>4934</b>	PA-24-84-2	<b>6669</b>	84" 3
PA-18-96-2	<b>5222</b>	PA-24-96-2	<b>7154</b>	96" 3
PA-18-108-2	<b>5543</b>	PA-24-108-2	<b>7567</b>	108" 3
PA-18-120-2	<b>5771</b>	PA-24-120-2	<b>7942</b>	120" 3
PA-18-132-2	<b>6179</b>	PA-24-132-2	<b>8354</b>	132" 4
PA-18-144-2	<b>6672</b>	PA-24-144-2	<b>9146</b>	144" 4

### Mounting Brackets Included

With Pass-Thru Shelving



**\*2" x 4" - L Bracket**  
For 18" Wide Shelves



**\*\*5" x 5" - Cantilever Bracket**  
For 24" Wide Shelves

### PASS-THRU MODIFICATION

Includes Side & Top • Minimum Length = 36"

#### Pass-Thru Frame

Length	Model	Price
36"	TA-84F-36	<b>\$1869</b>
48"	TA-84F-48	<b>2074</b>
60"	TA-84F-60	<b>2285</b>
72"	TA-84F-72	<b>2445</b>
84"	TA-84F-84	<b>2573</b>



**Print Required For Proper Location**

## Electrical Utility Chases

**Call For Wiring Installation!**



FLOOR CHASE



CEILING CHASE

- Conceals Wires
- Removable Panel For Wire Access.
- Wiring Available Upon Request.

Available only for CU Series & OTS Series Shelving (Pages 77 & 79)

MODEL	FEED TYPE	PRICE
UCC-1	Ceiling	<b>\$2471</b>
UCF-1	Floor	<b>2184</b>

**Print required for proper chase location.**  
**Utility Chase is FACTORY INSTALLATION only.**

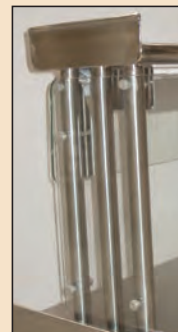

PIPE CHASE

- Conceals Wires For Heat Lamps.
- Required Installation Of Buyout Equipment

Consult Factory for Wiring

MODEL	PRICE
PC-1	<b>\$970 ea.</b>

# 18" & 24" WIDE TABLE MOUNTED SHELVING



# SHELVING Specialty Shelving

## For Existing Equipment For SMART FABRICATION™ CHEF'S LINE

- Stainless Steel Shelving (1 Tier or 2 Tier Shelves)
- Stainless Steel Posts (1" Posts Available)
- Mounting Brackets Included

Customer To Specify Models Of Buyout Equipment.  
Print Required.

### Call For a Custom Quote

Quote Prints Available On Request  
- A Service Only Advance Tabco Offers!  
Call Our Estimating Department At 800-645-3166  
or email smartFab@advancetabco.com

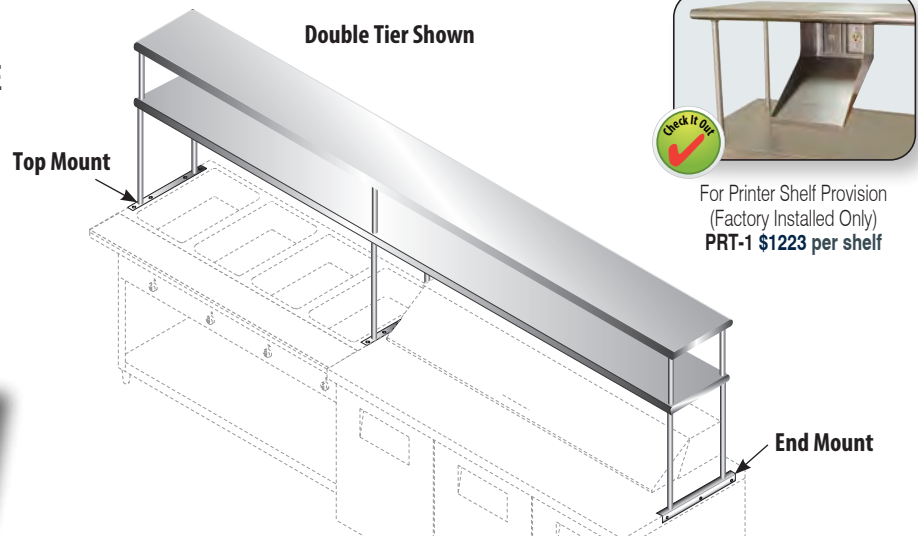

Single Tier Shelving							Double Tier Shelving						
Ft.	Approx. Cubes	18" WIDE	Approx. Price	Approx. Wt.	24" WIDE	Approx. Price	Approx. Wt.	18" WIDE	Approx. Price	Approx. Wt.	24" WIDE	Approx. Price	Approx. Wt.
4'	12	CU-18-48	\$2158	42 lbs.	CU-24-48	\$2668	55 lbs.	CU-18-48-2	\$4154	76 lbs.	CU-24-48-2	\$4569	114 lbs.
5'	15	CU-18-60	2228	53 lbs.	CU-24-60	2858	61 lbs.	CU-18-60-2	4352	95 lbs.	CU-24-60-2	4786	131 lbs.
6'	17	CU-18-72	2310	64 lbs.	CU-24-72	2983	70 lbs.	CU-18-72-2	4550	115 lbs.	CU-24-72-2	5004	152 lbs.
7'	20	CU-18-84	2617	75 lbs.	CU-24-84	3398	81 lbs.	CU-18-84-2	4938	135 lbs.	CU-24-84-2	5435	176 lbs.
8'	23	CU-18-96	2820	89 lbs.	CU-24-96	3658	98 lbs.	CU-18-96-2	5122	160 lbs.	CU-24-96-2	5634	207 lbs.
9'	26	CU-18-108	3042	95 lbs.	CU-24-108	4037	104 lbs.	CU-18-108-2	5347	121 lbs.	CU-24-108-2	5715	239 lbs.
10'	29	CU-18-120	3220	105 lbs.	CU-24-120	4344	113 lbs.	CU-18-120-2	5432	189 lbs.	CU-24-120-2	5800	283 lbs.
11'	32	CU-18-132	3396	118 lbs.	CU-24-132	4446	129 lbs.	CU-18-132-2	5431	212 lbs.	CU-24-132-2	5973	331 lbs.
12'	35	CU-18-144	3505	130 lbs.	CU-24-144	4948	146 lbs.	CU-18-144-2	5679	235 lbs.	CU-24-144-2	6249	387 lbs.

## Shelving Modifications

### Undermount Paper/Accessories Shelf

TA-117 \$386 /lin. ft.

#### Additional Fixed Partitions

(Specify Location For Factory Installation) TA-117A \$151 ea.

- 7" Wide x 12" High
- Two Adjustable Partitions To Create Separate Compartments

FACTORY INSTALLED ONLY

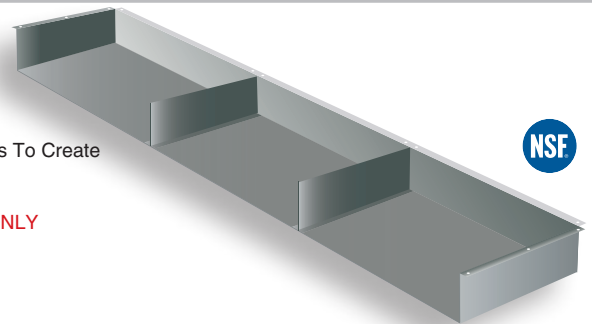

TA-9A	Partial 1" Turn-Up for all Table Mt. Shelves .....	\$65 /lin. ft.	TA-71	Heat Lamp Mounting Provision .....	\$239 ea.
TA-22A	Square Edge on Overshelf .....	151 ea.	TA-71A	Heat Lamp Remote Control Bracket.....	470 ea.
TA-26-10	Welded Wall Shelf Brackets for 10" Shelf.....	376 /shelf	TA-77	Check Minder Shelf Provision (Factory Install Only) .....	85 /lin. ft.
TA-26-12	Welded Wall Shelf Brackets for 12" Shelf.....	376 /shelf	TA-85	30" Wide CU Shelf (Add to price of 24" Shelf. For double tier, add twice) .....	302 /lin. ft.
TA-26-15	Welded Wall Shelf Brackets for 15" Shelf.....	376 /shelf	TA-99	16 Ga. S/S 304 Upgrade for Wall & Over Shelves .....	37 /lin. ft.
TA-26-18	Welded Wall Shelf Brackets for 18" Shelf.....	376 /shelf	TA-99A	14 Ga. S/S 304 Upgrade for Wall & Over Shelves .....	68 /lin. ft.
TA-33A	Customize Post Height (Specify Height) .....	74 /Shelf	TA-100A	Bull Nose Edge On all 4 Sides of Shelf .....	151 ea.
TA-47	Shelf Mounting Bracket for Existing Table .....	138 /shelf	TA-102	24" x 24" Extension for Microwave or Computer Shelf (Add to OTS and ODS Shelves. See page 77) .....	625 ea.
TA-49	Wall Shelf 2" Offset .....	266 /shelf	TA-103	24" Wide PT Shelf (36" Min Length. Mid mount only. PT Series Shelf, see pg. 48. Add to 18" Wide Shelf) .....	186 /lin. ft.
TA-60	Special Sizing Charge for Shelves (Must Order Larger Unit to be Cut Down to Smaller Size) .....	N/C	TA-104	Add'l Length Over 12' - Add to 18" or 24" Shelf (CU Shelving Only. Maximum Length is 14' as Single Piece) .....	402 /lin. ft.
TA-62C	Duplex Electrical Outlet (Under Flat Top) .....	705 ea.			
TA-62D	GFI Duplex Outlet in a Doghouse Box .....	749 ea.			

# SHELVING

## Wall Mounted Shelving



Brackets Can Be Positioned To Accommodate Wall Studs

### 16 GA. WALL MOUNTED SHELVING 304 Type Stainless Steel

• 1 1/2" Rolled Rim With A 1 1/2" Turn-Up At Rear Ends Are Turned Down Square

Length	10" WIDE	Price	12" WIDE	Price	15" WIDE	Price	18" WIDE	Price	Approx. Wt.	Approx. Cubes
2'	WS-10-24-16	\$521	WS-12-24-16	\$525	WS-15-24-16	\$723	WS-18-24-16	\$1224	10 lbs.	3
30"	-	-	WS-12-30-16	570	-	-	-	-	11 lbs.	3
3'	WS-10-36-16	561	WS-12-36-16	593	WS-15-36-16	838	WS-18-36-16	1281	12 lbs.	4
42"	-	-	WS-12-42-16	693	-	-	-	-	13 lbs.	5
4'	WS-10-48-16	590	WS-12-48-16	594	WS-15-48-16	960	WS-18-48-16	1336	14 lbs.	5
5'	WS-10-60-16	657	WS-12-60-16	693	WS-15-60-16	1059	WS-18-60-16	1478	17 lbs.	6
6'	WS-10-72-16	707	WS-12-72-16	788	WS-15-72-16	1205	WS-18-72-16	1624	19 lbs.	7
7'	WS-10-84-16	809	WS-12-84-16	821	WS-15-84-16	1283	WS-18-84-16	1704	22 lbs.	8
8'	WS-10-96-16	925	WS-12-96-16	947	WS-15-96-16	1360	WS-18-96-16	1775	26 lbs.	10
9'	WS-10-108-16	982	WS-12-108-16	982	WS-15-108-16	1418	WS-18-108-16	1917	28 lbs.	11
10'	WS-10-120-16	1042	WS-12-120-16	1042	WS-15-120-16	1531	WS-18-120-16	2133	31 lbs.	12
11'	WS-10-132-16	1130	WS-12-132-16	1130	WS-15-132-16	1726	WS-18-132-16	2214	35 lbs.	13
12'	WS-10-144-16	1166	WS-12-144-16	1166	WS-15-144-16	1832	WS-18-144-16	2296	38 lbs.	14

### 18 GA. WALL MOUNTED SHELVING 430 Type Stainless Steel

Length	10" WIDE	Price	12" WIDE	Price	15" WIDE	Price	18" WIDE	Price	Approx. Wt.	Approx. Cubes
2'	WS-10-24	\$417	WS-12-24	\$429	WS-15-24	\$498	WS-18-24	\$903	10 lbs.	3
30"	-	-	WS-12-30	487	-	-	-	-	12 lbs.	4
3'	WS-10-36	441	WS-12-36	489	WS-15-36	562	WS-18-36	949	12 lbs.	4
42"	-	-	WS-12-42	551	-	-	-	-	14 lbs.	5
4'	WS-10-48	471	WS-12-48	553	WS-15-48	635	WS-18-48	1075	14 lbs.	5
5'	WS-10-60	547	WS-12-60	610	WS-15-60	676	WS-18-60	1115	17 lbs.	6
6'	WS-10-72	592	WS-12-72	651	WS-15-72	732	WS-18-72	1217	19 lbs.	7
7'	WS-10-84	645	WS-12-84	718	WS-15-84	749	WS-18-84	1329	22 lbs.	8
8'	WS-10-96	746	WS-12-96	785	WS-15-96	868	WS-18-96	1408	26 lbs.	10
9'	WS-10-108	773	WS-12-108	855	WS-15-108	1161	WS-18-108	1639	28 lbs.	11
10'	WS-10-120	923	WS-12-120	973	WS-15-120	1193	WS-18-120	1704	31 lbs.	12
11'	WS-10-132	950	WS-12-132	1023	WS-15-132	1362	WS-18-132	1790	35 lbs.	13
12'	WS-10-144	990	WS-12-144	1049	WS-15-144	1442	WS-18-144	1874	38 lbs.	14

TA-22A	Square Edge Shelf	\$151 ea.
TA-26-10	Weld Support Brackets To Wall Shelf For 10" Deep Wall Shelves	376 ea.
TA-26-12	Weld Support Brackets To Wall Shelf For 12" Deep Wall Shelves	376 ea.
TA-26-15	Weld Support Brackets To Wall Shelf For 15" Deep Wall Shelves	376 ea.
TA-26-18	Weld Support Brackets To Wall Shelf For 18" Deep Wall Shelves	376 ea.
TA-49	2" Wall Shelf Offset	266 /shelf

TA-60	Special Sizing Charge For Shelves (Must Order Larger Unit To Be Cut Down To Smaller Size)	N/C
TA-71	Heat Lamp Mounting Provision	239 ea.
TA-77	Check Minder Provision On Any Shelf	85 /lin. ft.
TA-99A	14 Ga. S/S 304 Upgrade For Wall & Over Shelves	68 /lin. ft.
TA-100A	Bullnose Edge On All 4 Sides Of Shelf	151 ea.

### K.D. WALL SHELVES

Length	STAINLESS STEEL w/ Stainless Steel Brackets		Approx. Wt.	Approx. Cubes
	Model #	Price		
2'	WS-KD-24	\$366	10 lbs.	2
3'	WS-KD-36	380	12 lbs.	3
4'	WS-KD-48	423	14 lbs.	4
5'	WS-KD-60	475	17 lbs.	5



Width Of Shelf Is 11-1/8"

Single Shipping Container Can Be Shipped U.P.S.



Custom Sizes are Available. Contact Our SMART FABRICATION™ Department. 800-645-3166

# SHELVING

## Wall Mounted Shelving



### WALL SHELVES

#### Slotted Cook Line Wall Shelf



- Heavy Duty
- 304 Type Stainless Steel
- 21" Wide
- 1 1/2" Square Tubes
- 1 1/4" Spacing
- Tubular Support Brackets (Shipped Loose To Suit Wall Stud Location)

**TA-26-21 \$504 per shelf**  
Optional Factory Welded Shelf Brackets (Print Required)



L	Model #	Price	# of Brackets	Approx. Wt.	Approx. Cubes
48"	DT21-4	\$5391	2	90 lbs.	6
72"	DT21-6	8086	3	105 lbs.	8
96"	DT21-8	10779	3	145 lbs.	10
120"	DT21-10	13477	4	190 lbs.	13
144"	DT21-12	16169	4	210 lbs.	15

**NOTE: Recommend Field Welding Brackets To Underside Of Cook Line Shelf**

#### Built-In Check Minder



Floating Ball Mechanism Quickly Grabs Checks And Holds Them In Place

L	12" WIDE	Price	Approx. Wt.	Approx. Cubes
3'	WS-12-36CM	\$579	15 lbs.	4
4'	WS-12-48CM	639	19 lbs.	5
5'	WS-12-60CM	691	21 lbs.	6
6'	WS-12-72CM	737	25 lbs.	7
8'	WS-12-96CM	873	32 lbs.	10

#### Under Mounted Multi-Purpose Shelf

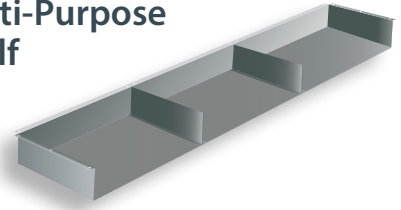

- Heavy Duty
- Mounts below shelving or table top
- Supplied with mounting holes.
- 1 stationary divider included 36" lengths & under 2 stationary dividers included over 36" lengths

Model #	Price	Approx. Wt.
TA-117	\$405 lin. ft.	22 lbs. per sq. ft.

TA-117A \$151 ea.  
Additional Dividers

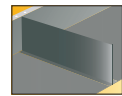

**FACTORY INSTALLED ONLY**

### with Built-In Pot Rack



Length	12" WIDE	Price	15" WIDE	Price	18" WIDE	Price	# of Hooks	Approx. Wt.	Approx. Cubes
3'	PS-12-36	\$1174	PS-15-36	\$1416	PS-18-36	\$1802	6	30 lbs.	5
4'	PS-12-48	1237	PS-15-48	1488	PS-18-48	1929	6	40 lbs.	6
5'	PS-12-60	1290	PS-15-60	1529	PS-18-60	1970	9	50 lbs.	7
6'	PS-12-72	1332	PS-15-72	1582	PS-18-72	2069	9	60 lbs.	8
7'	PS-12-84	1399	PS-15-84	1604	PS-18-84	2184	9	70 lbs.	10
8'	PS-12-96	1468	PS-15-96	1721	PS-18-96	2261	9	80 lbs.	11
9'	PS-12-108	1538	PS-15-108	2012	PS-18-108	2491	9	90 lbs.	12
10'	PS-12-120	1656	PS-15-120	2045	PS-18-120	2556	9	100 lbs.	13
11'	PS-12-132	1704	PS-15-132	2214	PS-18-132	2644	9	110 lbs.	14
12'	PS-12-144	1733	PS-15-144	2296	PS-18-144	2727	9	120 lbs.	26



**FOR CHECK MINDER PROVISION**  
On Any Shelf Use

TA-77  
\$85/lin. ft.



TA-60 Special Sizing Charge for Wall Shelves  
TA-99 16 ga. 304 Upgrade for Wall and Over Shelves  
TA-99A 14 Ga. S/S 304 Upgrade for Wall & Over Shelves

**N/C - Add to next longer shelf \$37 / lin. ft. 68 / lin. ft.**

#### Wall Shelf w/Multipurpose Undershelf

- 5 1/2" Undershelf
- Upper & Lower Grommet Holes



Shown with Microwave Units (Not Included)



Size W x L	Model #	Price	Approx. Wt.	Approx. Cubes
24" x 24"	MS-24-24-PS	\$2141	58 lbs.	11
24" x 36"	MS-24-36-PS	2503	85 lbs.	16
24" x 48"	MS-24-48-PS	2868	110 lbs.	21

#### Microwave Shelf



Size W x L	Model #	Price	Approx. Wt.	Approx. Cubes
18" x 24"	MS-18-24	\$818	27 lbs.	5
24" x 24"	MS-24-24	927	32 lbs.	5
24" x 36"	MS-24-36	1292	38 lbs.	7
20" x 30"	MS-20-30	1196	36 lbs.	5

TA-108 \$201  
2" Hole with Grommet For Appliance Cord.  
(Please Specify Hole Size And Location)



#### 8" Wide Utility Shelf



Length	Model #	Price	Approx. Wt.	Approx. Cubes
24"	K-245	\$1159	50 lbs.	1
36"	K-246	1316	55 lbs.	2

# SHELVING

## Shelving & Modifications

### 18" WIDE CEILING MOUNTED SHELVING

- Stainless Steel
- 1 5/8" Stainless Steel Posts
- Shipped KD
- Load Capacity is 5 lbs. per sq. ft. (Evenly Distributed)

SINGLE



DOUBLE



#### Single Shelf

Length	Model #	Price	Approx. Wt.	Approx. Cubes
3'	CM-18-36	\$3959	24 lbs.	4
4'	CM-18-48	4245	29 lbs.	5
5'	CM-18-60	4524	35 lbs.	6
6'	CM-18-72	4807	40 lbs.	7
7'	CM-18-84	4814	46 lbs.	8
8'	CM-18-96	4938	51 lbs.	9

#### Double Shelves

Length	Model #	Price	Approx. Wt.	Approx. Cubes
3'	DCM-18-36	\$5088	55 lbs.	5
4'	DCM-18-48	5938	60 lbs.	6
5'	DCM-18-60	6220	66 lbs.	7
6'	DCM-18-72	7071	72 lbs.	8
7'	DCM-18-84	7170	78 lbs.	9
8'	DCM-18-96	7405	84 lbs.	10

**CUSTOMER MUST SPECIFY CEILING HEIGHT**

= Ship Via UPS

### SHELVING MODIFICATIONS

FACTORY INSTALLED ONLY

#### Printer Shelf

- Heavy gauge stainless steel
- 8"x16" Printer Deck
- 10" height
- 1 Data Port Receptacle
- 1 Electrical Receptacle
- Rear Gem Box with Removable Enclosure
- Turned up front edge to hold Printer in place



**PRT-1 \$1284/shelf** Back of Shelf Shown

#### Check Minder



- Extruded Anodized Aluminum
- Holds checks with ease
- Floating ball mechanism quickly grabs checks & holds them in place
- Mounts to any shelf

**TA-77 \$85/lin. ft.**  
**TA-77A \$61/lin. ft.**

Concealer for Heat Lamp. (Requires a TA-77)

#### Microwave Shelf Extension



24" Front to Back  
1-5/8" Posts

Use the full length of OTS Shelves found on page 77 and then add **TA-102 \$625** extension. Specify Right or Left.

#### Table Mounted Equipment Shelf



1-5/8" Posts

L	Model #	Price	Approx. Wt.	Approx. Cubes
2'	MST-24-24	\$1694	32 lbs.	1
3'	MST-24-36	1979	38 lbs.	2

#### 6" Shelf Offset



- Posts located towards rear shelf
- Provides shelf reach
- Available for 18" or Wider shelving Only (CU Series Shelving)

**TA-120 \$187/Per level**

### Accessories

#### Check Minder Accessory



- Holds Checks With Ease
- Floating Ball Mechanism Quickly Grabs Checks & Holds Them In Place
- Mounts To Existing Wall Or Shelf

Length	Model #	Price	Approx. Wt.
2'	CM-24	\$81	1.5 lbs.
3'	CM-36	102	2.25 lbs.
4'	CM-48	117	3 lbs.
5'	CM-60	131	4.25 lbs.

#### Wall Cap



- 16 ga., 304 Stainless Steel
- 2" x Wall Thickness x 2" x Height

Model #	Price
<b>WALLCAP</b>	<b>\$83 Lin. ft.</b>

**MUST SPECIFY:**  
**Wall thickness** (maximum 6")  
**Height** (Maximum of 10 feet)  
 Minimum charge 4 linear feet

#### Bumper Guards



- 16 ga., 304 Stainless Steel
- Bracket Included

Model #	Size	Price
<b>BG-48</b>	2" x 4" x 48"	<b>\$313</b>
<b>BG-60</b>	2" x 4" x 60"	<b>423</b>

#### Outside Corner Guards

- 16 ga., 304 Stainless Steel
- Adhesive Tape Backing

2" x 2"

Model #	Size	Price
<b>CG-48</b>	2" x 2" x 48"	<b>\$212</b>
<b>CG-60</b>	2" x 2" x 60"	<b>279</b>
<b>CG-72</b>	2" x 2" x 72"	<b>311</b>
<b>CG-84</b>	2" x 2" x 84"	<b>366</b>
<b>CG-96</b>	2" x 2" x 96"	<b>401</b>
<b>CG-120</b>	2" x 2" x 120"	<b>435</b>
4" x 4"		
<b>OCG-48-SS</b>	4" x 4" x 48"	<b>401</b>

**Inner Corner Guards Available!**  
 Please call for more info!

# POT RACKS

## Additional Pot Racks

### STAINLESS STEEL WALL MOUNTED POT RACKS

Includes Pot Hooks

#### Single Bar

Length	Stainless Steel			Aluminum			# Of Hooks	Cu.
	Model #	Price	Wt.	Model #	Price	Wt.		
2'	NOT AVAILABLE			ALW-24	\$492	5 lbs.	6	1.0
3'	SW1-36	\$924	13 lbs.	ALW-36	610	6 lbs.	6	1.5
4'	SW1-48	950	15 lbs.	ALW-48	665	7 lbs.	6	2.0
5'	SW1-60	1017	17 lbs.	NOT AVAILABLE			9	2.5
6'	SW1-72	1009	19 lbs.		9	3.0		
7'	SW1-84	1034	21 lbs.		9	3.5		
8'	SW1-96	1136	23 lbs.		9	4.0		
9'	SW1-108	1251	25 lbs.		9	4.5		
10'	SW1-120	1360	27 lbs.				9	5.0

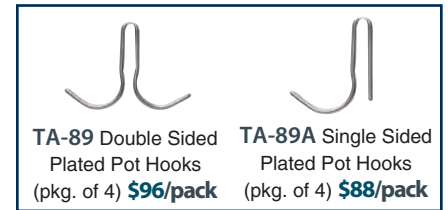

SW1-36 Shown

#### Double Bar

Length	Model #	Price	# Of Hooks	Wt.	Cu.
2'	SW-24	\$1280	12	18 lbs.	4
3'	SW-36	1386	12	22 lbs.	5
4'	SW-48	1432	12	26 lbs.	6
5'	SW-60	1539	18	30 lbs.	7
6'	SW-72	1617	18	34 lbs.	9
7'	SW-84	1786	18	44 lbs.	10
8'	SW-96	1852	18	48 lbs.	12
9'	SW-108	2190	18	52 lbs.	13
10'	SW-120	2395	18	56 lbs.	15
11'	SW-132	2599	18	60 lbs.	16
12'	SW-144	2748	18	64 lbs.	18



SW-36 Shown

### CEILING MOUNTED STAINLESS STEEL POT RACKS

Hangs 36" From Ceiling • Includes Pot Hooks



Length	Model #	Price	# Of Hooks	Wt.	Cu.
3'	SC-36	\$2378	12	42 lbs.	5
4'	SC-48	2423	12	48 lbs.	6
5'	SC-60	2524	18	54 lbs.	7
6'	SC-72	2633	18	60 lbs.	9
7'	SC-84	2936	18	66 lbs.	10
8'	SC-96	3323	18	80 lbs.	12
9'	SC-108	3704	18	86 lbs.	13
10'	SC-120	4148	18	92 lbs.	15
11'	SC-132	4370	18	98 lbs.	16
12'	SC-144	4852	18	104 lbs.	18

TA-98 Stainless Steel Flat Bar in lieu of Chain **\$414/pot rack**

### LEG MOUNTED POT RACK

For 30" Wide Tables

Includes 6 Pot Hooks Per Unit



Stainless Steel

UB-30   
**\$608**  
Wt. 10 lbs.

For Adjustable Pot Rack Components  
See Page 80

# POT RACKS

## Adjustable Pot Rack Components



**#1** HOW TO ORDER  
Select from  
3 Mounting  
Provisions

*Mid, Rear or Splash*

**#2** Choose  
Desired  
Components



### TABLE with POT RACK, SHELVING & UTENSIL RACK MID MOUNT DESIGN



MIX & MATCH to Maximize Your Work Area. Components are Adjustable. You set the Height to Meet Your Demanding Requirement.

#### SPECIFY MOUNTING PROVISION

FOR MID MOUNT  
Add TA-228 N/C



FOR REAR MOUNT  
ADD TA-229 N/C



FOR SPLASH MOUNT  
ADD TA-227 N/C



#### Pot Racks (Includes Utensil Rack)

#### Utensil Racks

Length	Model #	# of Pot Hooks	Price	Approx. Wt.	Approx. Cubes	Model #	# of Pot Hooks	Price	Approx. Wt.	Approx. Cubes
36"	SCT-36	12	\$2135	30	5	AUR-36	6	\$806	30	2
48"	SCT-48	12	2214	34	6	AUR-48	6	819	34	3
60"	SCT-60	18	2275	37	7	AUR-60	9	878	37	3
72"	SCT-72	18	3136	46	9	AUR-72	9	920	46	4
84"	SCT-84	18	3212	50	10	AUR-84	9	1077	50	5
96"	SCT-96	18	3430	55	12	AUR-96	9	1179	55	5
108"	SCT-108	18	4177	60	13	AUR-108	9	1483	60	6
120"	SCT-120	18	4526	65	15	AUR-120	9	1573	65	7
132"	SCT-132	18	4650	68	16	AUR-132	9	1781	68	7
144"	SCT-144	18	4742	72	18	AUR-144	9	1977	72	8
36"	SWT-36	12	\$1697	30	5	AUR-36	6	\$806	30	2
48"	SWT-48	12	1740	34	6	AUR-48	6	819	34	3
60"	SWT-60	18	1759	37	7	AUR-60	9	878	37	3
72"	SWT-72	18	1781	46	9	AUR-72	9	920	46	4
84"	SWT-84	18	2135	50	10	AUR-84	9	1077	50	5
96"	SWT-96	18	2174	55	12	AUR-96	9	1179	55	5
108"	SWT-108	18	2583	60	13	AUR-108	9	1483	60	6
120"	SWT-120	18	2611	65	15	AUR-120	9	1573	65	7
132"	SWT-132	18	2674	68	16	AUR-132	9	1781	68	7
144"	SWT-144	18	2736	72	18	AUR-144	9	1977	72	8
36"	SWT-36	12	\$1697	30	5	AUR-36	6	\$806	30	2
48"	SWT-48	12	1740	34	6	AUR-48	6	819	34	3
60"	SWT-60	18	1759	37	7	AUR-60	9	878	37	3
72"	SWT-72	18	1781	46	9	AUR-72	9	920	46	4
84"	SWT-84	18	2135	50	10	AUR-84	9	1077	50	5
96"	SWT-96	18	2174	55	12	AUR-96	9	1179	55	5
108"	SWT-108	18	2583	60	13	AUR-108	9	1483	60	6
120"	SWT-120	18	2611	65	15	AUR-120	9	1573	65	7
132"	SWT-132	18	2674	68	16	AUR-132	9	1781	68	7
144"	SWT-144	18	2736	72	18	AUR-144	9	1977	72	8

Pot Racks 8' Or Longer, Include Center Leg Support

# SHELVING

## Adjustable Shelving Components Convert Your Table into an Effective Work Station

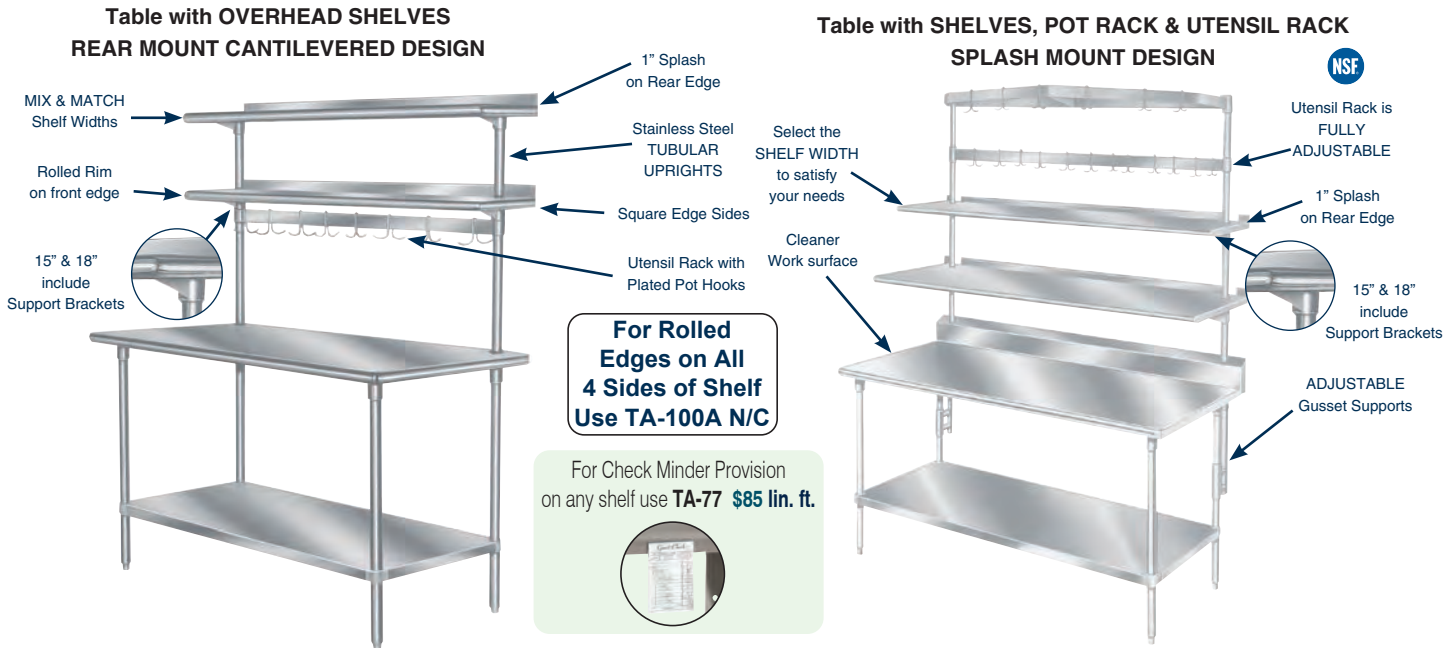

ADD - CHANGE - MODIFY with Components to Meet the Demanding Prep-Requirements of an Upgrading or Changing Food Service Environment

### Adjustable Shelves

Length	10" WIDE	Price	12" WIDE	Price	15" WIDE	Price	18" WIDE	Price	Approx. Wt.	Approx. Cubes
36"	PT-10-36	\$712	PT-12-36	\$747	PT-15-36	\$836	PT-18-36	\$931	30	2
48"	PT-10-48	764	PT-12-48	798	PT-15-48	893	PT-18-48	998	34	3
60"	PT-10-60	801	PT-12-60	855	PT-15-60	958	PT-18-60	1069	37	3
72"	PT-10-72	840	PT-12-72	903	PT-15-72	1012	PT-18-72	1130	46	4
84"	PT-10-84	878	PT-12-84	949	PT-15-84	1064	PT-18-84	1187	50	5
96"	PT-10-96	1229	PT-12-96	1327	PT-15-96	1488	PT-18-96	1660	55	5
108"	PT-10-108	1378	PT-12-108	1488	PT-15-108	1664	PT-18-108	1859	60	6
120"	PT-10-120	1540	PT-12-120	1664	PT-15-120	1867	PT-18-120	2082	65	7
132"	PT-10-132	1725	PT-12-132	1867	PT-15-132	2090	PT-18-132	2333	68	7
144"	PT-10-144	1933	PT-12-144	2090	PT-15-144	2340	PT-18-144	2611	72	8
36"	PT-10R-36	\$840	PT-12R-36	\$874	PT-15R-36	\$979	PT-18R-36	\$1092	30	2
48"	PT-10R-48	880	PT-12R-48	930	PT-15R-48	1044	PT-18R-48	1164	34	3
60"	PT-10R-60	930	PT-12R-60	990	PT-15R-60	1109	PT-18R-60	1238	37	3
72"	PT-10R-72	983	PT-12R-72	1049	PT-15R-72	1175	PT-18R-72	1313	46	4
84"	PT-10R-84	1034	PT-12R-84	1111	PT-15R-84	1244	PT-18R-84	1390	50	5
96"	PT-10R-96	1445	PT-12R-96	1556	PT-15R-96	1744	PT-18R-96	1945	55	5
108"	PT-10R-108	1619	PT-12R-108	1744	PT-15R-108	1952	PT-18R-108	2179	60	6
120"	PT-10R-120	1813	PT-12R-120	1952	PT-15R-120	2187	PT-18R-120	2440	65	7
132"	PT-10R-132	2033	PT-12R-132	2187	PT-15R-132	2450	PT-18R-132	2735	68	7
144"	PT-10R-144	2275	PT-12R-144	2450	PT-15R-144	2742	PT-18R-144	3060	72	8
36"	PT-10S-36	\$1071	PT-12S-36	\$1111	PT-15S-36	\$1244	PT-18S-36	\$1390	30	2
48"	PT-10S-48	1129	PT-12S-48	1173	PT-15S-48	1314	PT-18S-48	1466	34	3
60"	PT-10S-60	1173	PT-12S-60	1224	PT-15S-60	1370	PT-18S-60	1532	37	3
72"	PT-10S-72	1220	PT-12S-72	1292	PT-15S-72	1446	PT-18S-72	1615	46	4
84"	PT-10S-84	1274	PT-12S-84	1350	PT-15S-84	1511	PT-18S-84	1688	50	5
96"	PT-10S-96	1786	PT-12S-96	1891	PT-15S-96	2117	PT-18S-96	2364	55	5
108"	PT-10S-108	1964	PT-12S-108	2081	PT-15S-108	2331	PT-18S-108	2599	60	6
120"	PT-10S-120	2160	PT-12S-120	2287	PT-15S-120	2563	PT-18S-120	2860	65	7
132"	PT-10S-132	2376	PT-12S-132	2518	PT-15S-132	2818	PT-18S-132	3146	68	7
144"	PT-10S-144	2612	PT-12S-144	2770	PT-15S-144	3102	PT-18S-144	3460	72	8

Shelves 8' Or Longer, Include Center Leg Support

# DISHTABLE STANDARDS



Shown with 8" Deep Sink Bowl, Pre-rinse Basket & Slide Bar

## Features and Benefits

- 3/4" Radius Corner Sink Bowls
- 10 1/2" Tile Edge Backsplash
- 1 5/8" Tubular Legs
- Economical Savings
- Satin Finish

## SPEC-LINE "30" Series

- 14 ga. 304 Stainless Steel Top
- Stainless Steel Cross Bracing on Sides
- 16 ga. 304 Stainless Steel Legs & Adjust. Bullet Feet
- 10 1/2" Backsplash
- 8" Deep Sink Bowls (Soil Units)
- Includes Basket & Slide Bar



## STANDARD "70" Series

- 16 ga. 304 Stainless Steel Top
- Stainless Steel Cross Bracing on Sides
- Stainless Steel Legs and Adjust. Bullet Feet
- 10 1/2" Backsplash
- 5" Deep Sink Bowls (Soil Units)



WHEN PLACING AN ORDER, PLEASE PROVIDE THE DISH MACHINE MODEL NUMBER TO ENSURE PROPER DISHTABLE COMPATIBILITY.

Due to some machine manufacturer's recommendations for specific service access, the following modifications will apply...

### DTA-76 (Relocate sink location)

*Dish Machines that require a DTA-76:*

ES-4400, ES-6600, WH-series, APEX TSC-V  
CMA 180 (Right-side), 44, 66  
Hobart AM-15 (corner configuration) C-series, CL-series,  
CCS-66/77/86/110, CRS-series  
Jackson AJ-series, TS-series, TSC-series  
Meiko K-series  
Stero SCT-series

**DTA-76: No Charge**

### DTA-78 (Notch in backsplash to clear handle)

*Dish Machines that require a DTA-78:*

ADS HT-25, SS-25  
Blakeslee D-8, D-9  
Ecolab ES-4000  
Electrolux WT65  
Hobart AM-15 (Corner Configuration)

**DTA-78: \$214**

This Is A Partial List. Please Refer To Our "Product Support" Section At [www.advantetabco.com](http://www.advantetabco.com) For Updates.

**! ATTENTION:**

See Dish Machine Information on Pg. 83 to ensure proper compatibility



# DISHTABLES

## Soil Dishtables

### STRAIGHT SOIL DISHTABLES

Spec-Line S30 Series

Standard S70 Series

14 Ga.

16 Ga.

Nominal Size	Length	Model #	Price	Model #	Price	Approx. Weight	Approx. Cu. Ft.
3 Ft.	35"	DTS-S30-36LorR	\$3465	DTS-S70-36LorR	\$2609	70 lbs.	12
4 Ft.	47"	DTS-S30-48LorR	3901	DTS-S70-48LorR	3420	85 lbs.	17
5 Ft.	59"	DTS-S30-60LorR	4183	DTS-S70-60LorR	3716	100 lbs.	19
6 Ft.	71"	DTS-S30-72LorR	4517	DTS-S70-72LorR	4410	115 lbs.	23
7 Ft.	83"	DTS-S30-84LorR	4888	DTS-S70-84LorR	4709	125 lbs.	27
8 Ft.	95"	DTS-S30-96LorR	5034	DTS-S70-96LorR	4800	135 lbs.	31
9 Ft.	107"	DTS-S30-108LorR	5205	DTS-S70-108LorR	4885	235 lbs.	45
10 Ft.	119"	DTS-S30-120LorR	5447	DTS-S70-120LorR	5095	290 lbs.	50
12 Ft.	143"	DTS-S30-144LorR	6076	DTS-S70-144LorR	5358	320 lbs.	60

Faucet Holes are Splash Mounted 8" O.C.

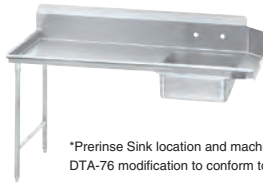

\*Prerinse Sink location and machine opening may require DTA-76 modification to conform to Dishmachine requirements.

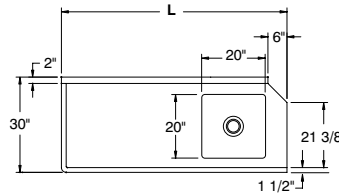

LEFT SOIL TABLE

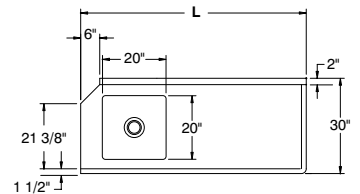

RIGHT SOIL TABLE



### CORNER SOIL DISHTABLES

Spec-Line K30 Series

Standard K70 Series

14 Ga.

16 Ga.

Nominal Size	Length	Model #	Price	Model #	Price	Approx. Weight	Approx. Cu. Ft.
4 Ft.	47"	DTS-K30-48LorR	\$9575	DTS-K70-48LorR	\$8754	128 lbs.	29
5 Ft.	59"	DTS-K30-60LorR	9803	DTS-K70-60LorR	8896	138 lbs.	37
6 Ft.	71"	DTS-K30-72LorR	9976	DTS-K70-72LorR	9117	149 lbs.	44
7 Ft.	83"	DTS-K30-84LorR	10253	DTS-K70-84LorR	9321	163 lbs.	51
8 Ft.	95"	DTS-K30-96LorR	10424	DTS-K70-96LorR	9552	182 lbs.	58
9 Ft.	107"	DTS-K30-108LorR	10806	DTS-K70-108LorR	10040	355 lbs.	83
10 Ft.	119"	DTS-K30-120LorR	11328	DTS-K70-120LorR	10907	380 lbs.	92
12 Ft.	143"	DTS-K30-144LorR	12515	DTS-K70-144LorR	10579	390 lbs.	110

Faucet Holes are Splash Mounted 8" O.C.



\*Prerinse Sink location and machine opening may require DTA-76 modification to conform to Dishmachine requirements.

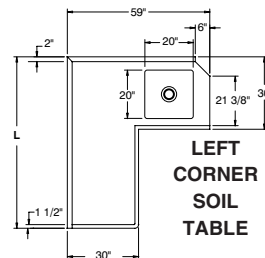

LEFT CORNER SOIL TABLE

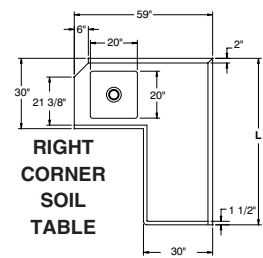

RIGHT CORNER SOIL TABLE

# DISHTABLES

## Soil Dishtables

**! ATTENTION:**  
See Dish Machine Information on Pg. 83 to ensure proper compatibility

### ISLAND SOIL DISHTABLES

Spec-Line G30 Series

Standard G70 Series

14 Ga.

16 Ga.

Nominal Size	Length	Model #	Price	Model #	Price	Approx. Weight	Approx. Cu. Ft.
4 Ft.	47"	DTS-G30-48LorR	<b>\$8966</b>	DTS-G70-48LorR	<b>\$8212</b>	129 lbs.	29
5 Ft.	59"	DTS-G30-60LorR	<b>9170</b>	DTS-G70-60LorR	<b>8362</b>	138 lbs.	37
6 Ft.	71"	DTS-G30-72LorR	<b>9406</b>	DTS-G70-72LorR	<b>8559</b>	150 lbs.	44
7 Ft.	83"	DTS-G30-84LorR	<b>9608</b>	DTS-G70-84LorR	<b>8811</b>	162 lbs.	51
8 Ft.	95"	DTS-G30-96LorR	<b>9774</b>	DTS-G70-96LorR	<b>8993</b>	178 lbs.	58
9 Ft.	107"	DTS-G30-108LorR	<b>10029</b>	DTS-G70-108LorR	<b>9428</b>	335 lbs.	83
10 Ft.	119"	DTS-G30-120LorR	<b>10449</b>	DTS-G70-120LorR	<b>10231</b>	365 lbs.	92
12 Ft.	143"	DTS-G30-144LorR	<b>11018</b>	DTS-G70-144LorR	<b>10799</b>	380 lbs.	110



\*Pre-rinse Sink location and machine opening may require **DTA-76** modification to conform to Dishmachine requirements.

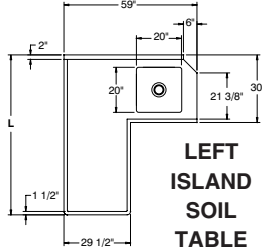

**LEFT ISLAND SOIL TABLE**

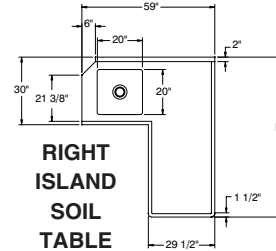

**RIGHT ISLAND SOIL TABLE**

Faucet Holes are Splash Mounted 8" O.C.

### DISHLANDING SOIL DISHTABLES

Spec-Line D32 Series

Standard D70 Series

15 Ga.

16 Ga.

Nominal Size	Length	Model #	Price	Model #	Price	Approx. Weight	Approx. Cu. Ft.
4 Ft.	47"	DTS-D32-48LorR	<b>\$10225</b>	DTS-D70-48LorR	<b>\$9780</b>	139 lbs.	33
5 Ft.	59"	DTS-D32-60LorR	<b>10439</b>	DTS-D70-60LorR	<b>9979</b>	147 lbs.	41
6 Ft.	71"	DTS-D32-72LorR	<b>10712</b>	DTS-D70-72LorR	<b>10202</b>	160 lbs.	50
7 Ft.	83"	DTS-D32-84LorR	<b>11040</b>	DTS-D70-84LorR	<b>10429</b>	175 lbs.	58
8 Ft.	95"	DTS-D32-96LorR	<b>11117</b>	DTS-D70-96LorR	<b>10664</b>	205 lbs.	66
9 Ft.	107"	DTS-D32-108LorR	<b>11642</b>	DTS-D70-108LorR	<b>10901</b>	320 lbs.	93
10 Ft.	119"	DTS-D32-120LorR	<b>12112</b>	DTS-D70-120LorR	<b>11535</b>	365 lbs.	103
12 Ft.	143"	DTS-D32-144LorR	<b>12641</b>	DTS-D70-144LorR	<b>12031</b>	390 lbs.	123



\*Pre-rinse Sink location and machine opening may require **DTA-76** modification to conform to Dishmachine requirements.

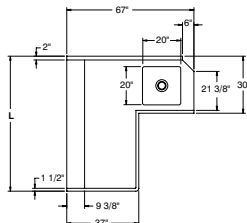

**LEFT DISHLANDING SOIL TABLE**

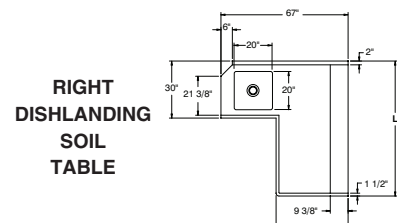

**RIGHT DISHLANDING SOIL TABLE**

**! ATTENTION:**

See Dish Machine Information on Pg. 83 to ensure proper compatibility

# DISHTABLES

## Clean Dishtables

### STRAIGHT CLEAN DISHTABLES

Spec-Line S30 Series

Standard S70 Series

14 Ga.

16 Ga.

Nominal Size	Length	Model #	Price	Model #	Price	Approx. Weight	Approx. Cu. Ft.
2 Ft.	23"	DTC-S30-24LorR	\$2573	DTC-S70-24LorR	\$2430	35 lbs.	12
3 Ft.	35"	DTC-S30-36LorR	3117	DTC-S70-36LorR	2791	45 lbs.	12
4 Ft.	47"	DTC-S30-48LorR	3264	DTC-S70-48LorR	3039	60 lbs.	17
5 Ft.	59"	DTC-S30-60LorR	3479	DTC-S70-60LorR	3219	70 lbs.	19
6 Ft.	71"	DTC-S30-72LorR	3670	DTC-S70-72LorR	3374	85 lbs.	23
7 Ft.	83"	DTC-S30-84LorR	4455	DTC-S70-84LorR	3749	100 lbs.	27
8 Ft.	95"	DTC-S30-96LorR	4662	DTC-S70-96LorR	4065	110 lbs.	31
9 Ft.	107"	DTC-S30-108LorR	5184	DTC-S70-108LorR	4584	225 lbs.	45
10 Ft.	119"	DTC-S30-120LorR	5390	DTC-S70-120LorR	4939	250 lbs.	50
12 Ft.	143"	DTC-S30-144LorR	5925	DTC-S70-144LorR	5409	270 lbs.	60



**NSF**  
Optional Undershelf

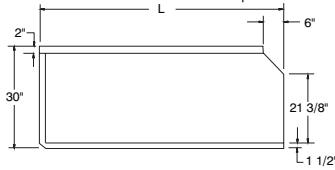

LEFT CLEAN TABLE

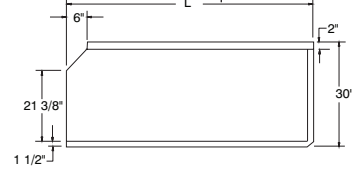

RIGHT CLEAN TABLE

### CORNER CLEAN DISHTABLES

Spec-Line K30 Series

Standard K70 Series

14 Ga.

16 Ga.

Nominal Size	Length	Model #	Price	Model #	Price	Approx. Weight	Approx. Cu. Ft.
4 Ft.	47"	DTC-K30-48LorR	\$6887	DTC-K70-48LorR	\$6402	105 lbs.	29
5 Ft.	59"	DTC-K30-60LorR	7081	DTC-K70-60LorR	6578	115 lbs.	37
6 Ft.	71"	DTC-K30-72LorR	7385	DTC-K70-72LorR	7059	125 lbs.	44
7 Ft.	83"	DTC-K30-84LorR	7734	DTC-K70-84LorR	7331	138 lbs.	51
8 Ft.	95"	DTC-K30-96LorR	7816	DTC-K70-96LorR	7421	157 lbs.	58
9 Ft.	107"	DTC-K30-108LorR	9689	DTC-K70-108LorR	9168	330 lbs.	83
10 Ft.	119"	DTC-K30-120LorR	10152	DTC-K70-120LorR	9590	360 lbs.	92
12 Ft.	143"	DTC-K30-144LorR	11167	DTC-K70-144LorR	10486	380 lbs.	110



**NSF**

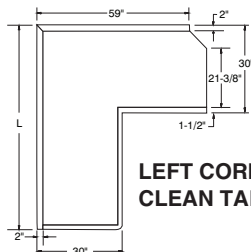

LEFT CORNER CLEAN TABLE

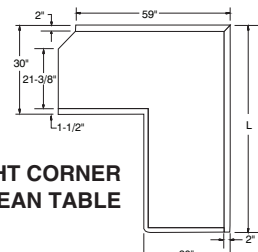

RIGHT CORNER CLEAN TABLE

# Clean Dishtables

**! ATTENTION:**  
See Dish Machine Information on Pg. 83 to ensure proper compatibility

## ISLAND CLEAN DISHTABLES

Spec-Line G30 Series      Standard G70 Series  
14 Ga.      16 Ga.

Nominal Size	Length	Model #	Price	Model #	Price	Approx. Weight	Approx. Cu. Ft.
4 Ft.	47"	DTC-G30-48LorR	\$6692	DTC-G70-48LorR	\$6038	102 lbs.	29
5 Ft.	59"	DTC-G30-60LorR	6890	DTC-G70-60LorR	6293	112 lbs.	37
6 Ft.	71"	DTC-G30-72LorR	7193	DTC-G70-72LorR	6443	125 lbs.	44
7 Ft.	83"	DTC-G30-84LorR	7531	DTC-G70-84LorR	6731	135 lbs.	51
8 Ft.	95"	DTC-G30-96LorR	7618	DTC-G70-96LorR	6825	148 lbs.	58
9 Ft.	107"	DTC-G30-108LorR	9429	DTC-G70-108LorR	8401	310 lbs.	83
10 Ft.	119"	DTC-G30-120LorR	9762	DTC-G70-120LorR	8988	340 lbs.	92
12 Ft.	143"	DTC-G30-144LorR	10738	DTC-G70-144LorR	10067	360 lbs.	110

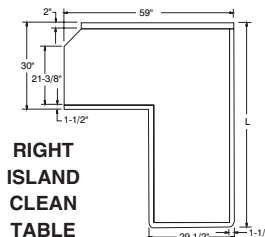
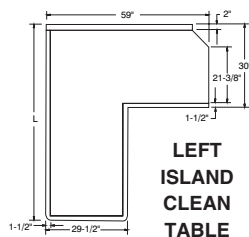

## U-SHAPED SOIL DISHTABLES

Nominal Size	Length	Model #	Price	Approx. Weight	Approx. Cu. Ft.
6 Ft.	71"	DTS-U30-72LorR	\$17316	450 lbs.	99
7 Ft.	83"	DTS-U30-84LorR	17649	470 lbs.	114
8 Ft.	95"	DTS-U30-96LorR*	18327	490 lbs.	130
9 Ft.	107"	DTS-U30-108LorR*	18799	525 lbs.	145
10 Ft.	119"	DTS-U30-120LorR*	19276	550 lbs.	160
11 Ft.	131"	DTS-U30-132LorR*	19580	575 lbs.	176
12 Ft.	143"	DTS-U30-144LorR*	19914	lbs. 600	192

\*Includes Field Joint (To be welded in field by others)

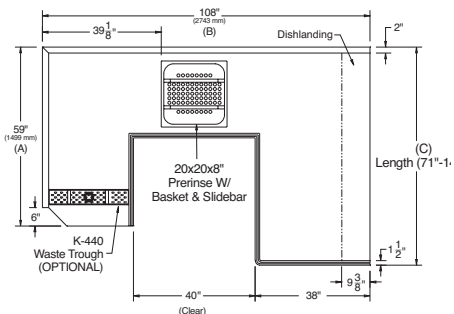

- Includes Prerinse sink basket and bar slide and dishlanding.
- Additional length on any leg of dishtables, use DTA-56 \$316 per ft. (Field joint may be required)
- Additional custom lengths available on all sides.
- If any 2 sides are larger than 90°, a welded field joint is required (WELDED BY OTHERS). USE K-57 \$411.
- For additional accessories and modifications, see pages 88-90. Dishlanding may be replaced with backslash or rolled edge at no additional charge.

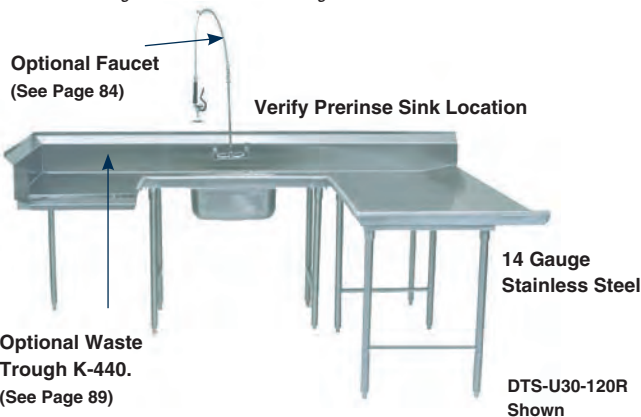

### Prerinse Basket with Welded Slide Bar

All Stainless Steel  
Type 304 Series  
Perforated Basket for  
3/4" Radius Bowls

Model #	Size	Price
DTA-100	19 1/2" x 19 1/2" 12 lbs. 1 Cu. Ft.	\$950



4" Depth

### Prerinse Slide Bar

Model #	Size	Price
DTA-60	19 1/2" x 19 1/2" 9 lbs. 1 Cu. Ft.	\$546

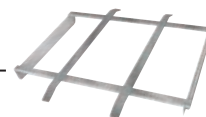

**ATTENTION:**

See Dish Machine Information on Pg. 83 to ensure proper compatibility

Faucets Can Be Found On Page 94

# DISHTABLES

## Specialty Dishtables

### DISHTABLE WITH 3 COMPARTMENT BOWLS

• 16 Gauge Stainless Steel • Stainless Steel Legs and Cross Rails • Stainless Steel Bullet Feet

#### Multiple Bowl Choices & Lengths

#### DEEP DRAWN BOWLS

Model #	Price	Length	Bowl Size	Drainboard Size	Approx. Weight
DTC93-1620-6LorR	<b>\$8635</b>	72"	16" x 20" x 12"	4"	200 lbs.
DTC93-1620-7LorR	<b>8990</b>	84"	16" x 20" x 12"	16"	220 lbs.
DTC93-1620-8LorR	<b>9282</b>	96"	16" x 20" x 12"	28"	240 lbs.
DTC93-1620-9LorR	<b>9760</b>	108"	16" x 20" x 12"	40"	275 lbs.
DTC93-2020-8LorR	<b>9692</b>	96"	20" x 20" x 12"	16"	260 lbs.
DTC93-2020-9LorR	<b>10167</b>	108"	20" x 20" x 12"	28"	310 lbs.
DTC93-2020-10LorR	<b>10496</b>	120"	20" x 20" x 12"	40"	310 lbs.

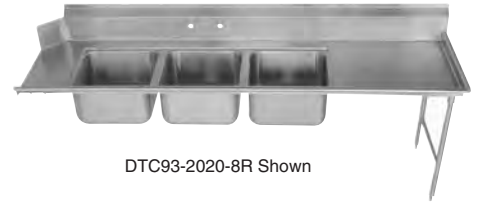

DTC93-2020-8R Shown

**BOWLS ARE LOCATED 12" IN FROM MACHINE**

For Other Configurations, Contact Factory

*(Must Verify Machine For Control Box Or Drive Unit Interference)*

#### FABRICATED BOWLS

Model #	Price	Length	Bowl Size	Drainboard Size	Approx. Weight
DTC-3-1620-66LorR	<b>\$8447</b>	66"	16" x 20" x 14"	6"	200 lbs.
DTC-3-1620-84LorR	<b>8715</b>	83"	16" x 20" x 14"	23"	220 lbs.
DTC-3-1620-96LorR	<b>8870</b>	95"	16" x 20" x 14"	35"	240 lbs.
DTC-3-1620-120LorR	<b>9337</b>	119"	16" x 20" x 14"	59"	265 lbs.
DTC-3-1620-144LorR	<b>10244</b>	143"	16" x 20" x 14"	83"	290 lbs.
DTC-3-1824-96LorR	<b>9720</b>	95"	18" x 24" x 14"	29"	350 lbs.
DTC-3-1824-108LorR	<b>10108</b>	107"	18" x 24" x 14"	41"	250 lbs.
DTC-3-1824-120LorR	<b>10382</b>	119"	18" x 24" x 14"	53"	260 lbs.
DTC-3-1824-144LorR	<b>10911</b>	143"	18" x 24" x 14"	77"	365 lbs.
DTC-3-2020-84LorR	<b>9030</b>	83"	20" x 20" x 14"	11"	240 lbs.
DTC-3-2020-96LorR	<b>9296</b>	95"	20" x 20" x 14"	23"	260 lbs.
DTC-3-2020-108LorR	<b>9516</b>	107"	20" x 20" x 14"	35"	285 lbs.
DTC-3-2020-120LorR	<b>9952</b>	119"	20" x 20" x 14"	48"	310 lbs.
DTC-3-2020-144LorR	<b>11154</b>	143"	20" x 20" x 14"	71"	340 lbs.
DTC-3-2424-120LorR*	<b>10815</b>	119"	24" x 24" x 14"	35"	350 lbs.
DTC-3-2424-144LorR*	<b>12938</b>	143"	24" x 24" x 14"	59"	380 lbs.



DTC-3-1620-84L Shown

\* Requires Two Faucets

For Upgrade To 14 Gauge Use "DTA-49" \$905

#### CORNER FABRICATED BOWLS

- 16 Gauge Stainless Steel
- Stainless Steel Legs and adjustable Cross Rails
- Stainless Steel Bullet Feet

Model #	Price	Length	Bowl Size	Drainboard Length	Approx. Weight
DTC-3-K20-72LorR	<b>\$9030</b>	72"	20" x 20" x 12"	24"	270 lbs.
DTC-3-K20-96LorR	<b>9345</b>	96"	20" x 20" x 12"	48"	310 lbs.



#### PRERINSE BASKETS & WELDED SLIDE BARS

##### Prerinse Baskets with Slide Bar

Model #	Fits Bowls	Price	Wt.	Cu.
DTA-125	16" x 20" x 4"	<b>\$830</b>	9 lbs.	1
DTA-100	20" x 20" x 4"	<b>950</b>	12 lbs.	1
Large Size Baskets				
DTA-58	18" x 24" x 4"	<b>1212</b>	11 lbs.	1
DTA-59	24" x 24" x 4"	<b>1381</b>	20 lbs.	1



DTA-100 Shown

##### Prerinse Slide Bars

Model #	Fits Bowls	Price	Wt.	Cu.
DTA-64	16" x 20"	<b>\$470</b>	7 lbs.	1
DTA-60	20" x 20"	<b>546</b>	9 lbs.	1
Large Size Prerinse Slide Bars				
DTA-51	18" x 24"	<b>688</b>	8 lbs.	1
DTA-52	24" x 24"	<b>817</b>	10 lbs.	1

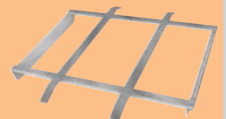

Prerinse Baskets &amp; Slide Bar For Deep Drawn Bowls, See Page 87

# DISHTABLES

## Specialty Dishtables, Hoods & Risers

### UNDERCOUNTER DISHTABLE

20" x 20" x 5" Sink Bowl

Length	Model #	Price	Approx. Weight	Approx. Cu. Ft.
48"	DTU-U60-48LorR	\$4208	80 lbs.	17
60"	DTU-U60-60LorR	4432	95 lbs.	19
72"	DTU-U60-72LorR	4610	115 lbs.	23



DTU-U60-48R Shown

Left Or Right Designation Is Determined By Sink Location.

### STAINLESS STEEL CONDENSATE HOODS

Model #	Length	Width	Height	Price
CH-3636	36"	36"	20"	\$4095
CH-4242	42"	42"	20"	4410
CH-4848	48"	48"	20"	5040
CH-61	Specify Alternate Collar Location			267
CH-56	Additional Length Or Width			420 /lin. Ft.



8" x 10" vent opening.  
Collar is centered 2" in height.

### STAINLESS STEEL VENT RISER

- Type 300 Stainless Steel
- Adjustable Ceiling Trim Collar
- Accommodates Standard 4" x 16" Vent Hood Duct

Model #	Length	Width	Height	Price
VR-1	16"	4"	60"	\$3032

(Custom Sizes Available - Consult Factory)

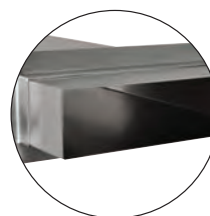

View of Opening

**CAN WE HELP YOU?**

Call Customer Service at:  
800-645-3166 or [customer@advancetabco.com](mailto:customer@advancetabco.com)

# DISHTABLE MODS

## Dishtable Modifications & Accessories

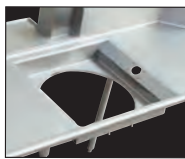

DTA-95

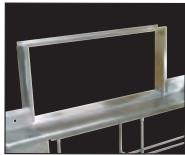

DTA-87



DTA-82



DTA-45

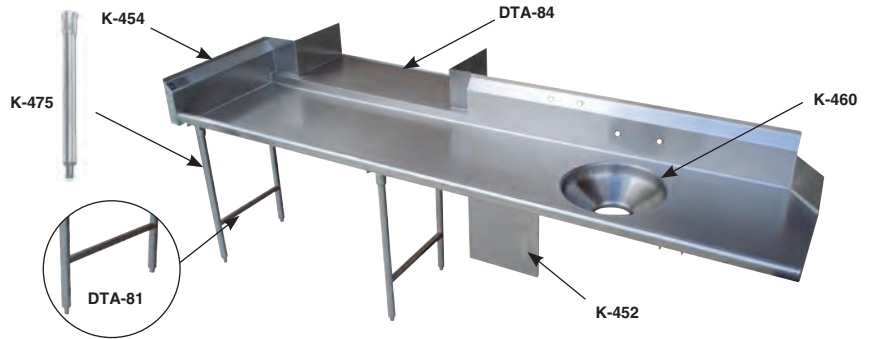

### MODIFICATIONS

K-23	Dishtable Legs Welded To Undershelf Or Left-To-Right Cross Rails, Shipped Set Up & Crated. (Top Is Not Welded To Legs)	\$589 /sink
K-23A	Dishtable Legs Welded To Leg Gussets Under Sink Top & To Undershelf Or Left-To-Right Cross Rails, Shipped Set Up & Crated	778 /sink
K-24	Shell Crating	455
K-37	Anti-Siphon Vacuum Breaker Hole	176
K-57	Welded Field Joint (Welded In Field By Others)	411
K-76	Paint On Sound Deadening	783 /sink
K-77	Splash Cut-Out (Pipe Chase)	278
K-440	Waste Trough Installation Welded Into Table And Furnished With A 2" Deep Removable Basket	1341
K-452	Control Bracket 8" x 12"	392 ea.
K-453	Control Bracket 14" x 16"	420 ea.
K-454	Side Splash	610 ea.
K-456	Scrap Block Installed (Includes Rubber Scrap Block)	573 ea.
K-460	Disposal Cone Welded Into Table And Furnished With 8" x 12" Control Bracket & Faucet Holes (Supplied By Others)	1171
K-460A	Installation Of Disposal Cone With 14" x 16" Control Bracket, Faucet Holes (Cone Supplied By Others)	1243
K-461	Disposal Collar Welded Into Sink Bowl And Furnished With 8" x 12" Control Bracket (Supplied By Others)	1171
K-461A	Disposal Collar Welded Into Sink Bowl And Furnished With 14" x 16" Control Bracket (Supplied By Others)	1243
K-472	Special Faucet Hole Location	185 ea.
K-495	Turn Down Backsplash (Incl. 2 Brackets. See K-397 For Add'l Sets)	245
K-508A	Special Modification Charge	373
K-550	Stainless Steel Tubular Rack Storage	293 lin. ft.

DTA-40	Drain Hole (For Sorting Table)	\$201
DTA-45	Scrap Trough Welded To Dump Sink - Min. Scrap Trough Length Is 3'. Max. Length Is 8'. For 20" x 20" x 8" Bowl Spec-Line Soil S30 Series Only. - Consult Factory For Trough Lengths Exceeding 8 Feet	530 lin. ft.
DTA-46	Inside Mitered Corner	789
DTA-66	Provision For Dishlanding On Straight Soil Table (Min 4')	387 /lin. Ft.
DTA-70	Install Booster Heater Brackets (Brackets By Others)	249
DTA-72	Provision For Side Loader	1615
DTA-75	Provision For Limit Switch (Limit Switch By Others)	284
DTA-76	Move Prerinse Sink To Conform To Dishmachine Requirements. Please Specify Machine When Placing Order	N/C
DTA-78	Notch In Backsplash Return To Clear Handle Please Specify Machine When Placing Order	214
DTA-81	S/S Welded Leg Assembly with S/S Feet	453 /bowl
DTA-82	15" x 20" x 8" Undercounter Dump Sink (Factory-prepared for field installation only)	3813 /bowl
DTA-84	Simple Pass-Thru (Specify Wall Thickness - Min. Length 36")	940 /Ft.
DTA-87	Pass-Thru Wall Frame (Specify Wall Thickness - Min. Length 36")	538 /lin. Ft.
DTA-95	Install Scrapper Top	2597
DTA-96	Install Trough Collector	3195
DTA-99A	16" x 20" x 12" Sink Bowls	2008 /bowl
DTA-99B	20" x 20" x 12" Sink Bowls	2157 /bowl
DTA-99C	10" x 14" x 5" Dump Sink	1718 /bowl
DTA-99D	18" x 24" x 14" Sink	2356 /bowl
DTA-99E	24" x 24" x 14" Sink	2510 /bowl
DTA-106	Mirror Highlight To Dishtable Upgrade	620

### ACCESSORIES

K-4	Lever Drain Bracket	\$198
K-5	Twist Handle Operated Drain	407
K-15	Twist Handle Operated Drain With Overflow	748
K-397	Wall Brackets (2 Each. Brackets Included With K-495)	125 /set
K-455C	Stainless Steel Sink Cover 16" x 20"	726
K-455E	Stainless Steel Sink Cover 20" x 20"	726
K-457	Replacement Rubber Scrap Block (See K-456 For Install Cost)	174 ea.
K-475	Replacement S/S Leg With Stainless Steel Bullet Foot	105 ea.
K-478	Replacement Stainless Steel Bullet Foot	42 ea.
K-488	Flanged S/S Bullet Foot	89 ea.
K-550	Stainless Steel Tubular Rack Storage	293 /lin. Ft.
K-610	Perforated Stainless Steel Sink Grid (Specify Bowl Size)	1119 ea.
K-700D	12" High Removable Side Splash For Dishtables (Specify Model)	708 ea.
DTA-53	SPEC-LINE Heavy Duty Prerinse Faucet	1158
DTA-51	Pre-Rinse Slide Bar for 18" x 24" Fab. Sink Bowls	688

DTA-52	Pre-Rinse Slide Bar for 24" x 24" Fab. Sink Bowls	\$817
DTA-55	Column Notch (Includes Splash)	1119
DTA-56	Add'l Length On 59" Side Of Corner Or Straight Tables	316 /lin. Ft.
DTA-58	Pre-Rinse Basket w/ Slide Bar for 18" x 24" Fab. Sink Bowls	1212
DTA-59	Pre-Rinse Basket w/ Slide Bar for 24" x 24" Fab. Sink Bowls	1381
DTA-60	Prerinse Slide Bar for 20" x 20" Fab. Sink Bowls	546
DTA-62	Prerinse Basket For 20" x 20" Deep Drawn Bowls	1192
DTA-63	Prerinse Slide Bar For 20" x 20" Deep Drawn Bowls	546
DTA-64	Prerinse Slide Bar For 16" x 20" Fab. Sink Bowls	470
DTA-65	Prerinse Slide Bar For 16" x 20" Deep Drawn Bowls	470
DTA-67	Stainless Steel Rear Cross-Bracing (Factory Installed Only)	53 /lin. Ft.
DTA-69	Prerinse Basket For 16" x 20" Deep Drawn Bowls	1134
DTA-100	Prerinse Basket with Slide Bar for 20" x 20" Fab. Sink Bowls	950
DTA-125	Prerinse Basket with Slide Bar for 16" x 20" Fab. Sink Bowls	830
DTA-125A	Prerinse Scrap Basket For DTA-82 Undermount Dump Sink	1109

# Dishtables

## Dishtable Faucets & Accessories

= Ships via UPS

### SPEC-LINE EXTRA HEAVY DUTY 14" Splash Mounted Swing Spout Faucet



8" O.C.

**K-105 \$613**   
T&S Equivalent Model # B231

Splash Mounted  
Prerinse Faucet

**K-116 \$1846**

12" Add-A-Faucet

**K-117-TS \$810**   
(Fits K-116 Only)

### Prerinse Faucets

Prerinse Features:

- 8" O.C.
- Wall Bracket
- Continuous Spray Ring
- Heavy Duty Chrome Plated Spring

SPEC-LINE  
HEAVY DUTY  
Splash Mounted

**DTA-53 \$1158**

T&S Equivalent  
Model # B133-B

12" Add-A-Faucet

**K-117 \$272**   
(Fits DTA-53 Only)

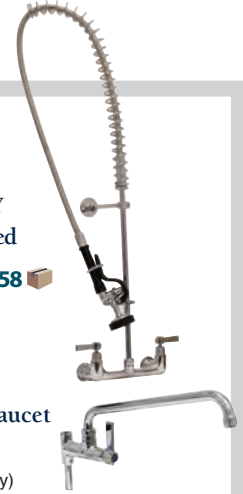

### Table Mounted SORTING SHELVES

Mounts to backsplash and end roll of dishtable  
(D, G and U-shaped Dishtables only)

Shelf Shipped Separate From Table To Reduce Freight  
Costs And Chance Of Shipping Damage.



New Versatile Design allows for  
Different Glass Rack Applications

- Drip Tubes For Water Drainage
- 14 Gauge End Plates
- 16 Gauge, 1 5/8" Tubes

**DTA-79 \$546 /lin. Ft.**



- Drip Tubes For Water Drainage
- 14 Gauge End Plates & Base
- 18 Gauge, 1 5/8" Tube

**DTA-79S \$896 /lin. Ft.**

### STAINLESS STEEL UNDERSHELVES

Additional Storage

Shelving Is Reversible (Left Or Right)



Size Undershell To Be At Least  
6" Shorter Than Dishtable.

Now With Stainless Steel Legs!

Length	Model #	Price	Approx. Wt.	Approx. Cubes
18"	DTA-SS-18	\$665	11 lbs.	1
24"	DTA-SS-24	758	13 lbs.	1
30"	DTA-SS-30	800	15 lbs.	1
42"	DTA-SS-42	853	20 lbs.	2
54"	DTA-SS-54	972	23 lbs.	2
66"	DTA-SS-66	1096	30 lbs.	3
78"	DTA-SS-78	1162	35 lbs.	3
90"	DTA-SS-90	1239	39 lbs.	4
102"	DTA-SS-102	1405	45 lbs.	5
114"	DTA-SS-114	1464	50 lbs.	5
126"	DTA-SS-126	1725	55 lbs.	6
138"	DTA-SS-138	1800	59 lbs.	6

### SORTING SHELVES

Traditional Design

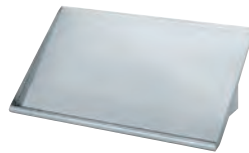

KD Tubular Design



FOR TABLE MOUNTED, ADD DTA-88 \$851

Length	Model #	Racks	Price	Approx. Wt.	Approx. Cubes
22"	DT-6R-11	1	\$1912	20 lbs.	1
42"	DT-6R-12	2	2045	30 lbs.	2
62"	DT-6R-13	3	2148	40 lbs.	4
82"	DT-6R-14	4	2289	50 lbs.	5

Length	Model #	Racks	Price	Approx. Wt.	Approx. Cubes
22"	DT-6R-21	1	\$1424	15 lbs.	1
42"	DT-6R-22	2	1607	23 lbs.	2
62"	DT-6R-23	3	1713	30 lbs.	4
82"	DT-6R-24	4	1820	38 lbs.	5

### SORTING TABLES

16 Gauge 304 Stainless Steel • 3" Raised Edge  
**STAINLESS STEEL CROSS BRACING ON ALL SIDES**

#### Standard

Model #	Price	Size	Approx. Wt.	Approx. Cubes
SR-48	\$3114	48" x 30"	84 lbs.	12
SR-60	3295	60" x 30"	98 lbs.	15
SR-72	3479	72" x 30"	109 lbs.	18
SR-96	3889	96" x 30"	143 lbs.	21



Shown With  
Optional Casters

#### 10 1/2" Backsplash

Model #	Price	Size	Approx. Wt.	Approx. Cubes
BSR-48	\$3149	48" x 30"	88 lbs.	12
BSR-60	3319	60" x 30"	103 lbs.	15
BSR-72	3498	72" x 30"	115 lbs.	18
BSR-96	4022	96" x 30"	150 lbs.	21



- TA-255 Super Heavy Duty Casters ..... \$831
- DTA-40 Drain Hole ..... 201

**WARNING:** Faucets on this page may contain a chemical known to the State of California to cause cancer, birth defects or other reproductive harm.

# Underbar Basics™

## Featuring New Extended Widths!

Sinks, Blender Stations, Drainboards & Liquor Racks now have a new flush design for a clean, linear appearance when adding SRK Speed Rails.



### Features and Benefits

- 18", 21", 23" & 26" Widths
- 4" Backsplash
- All Units Come with 4 Galvanized Legs w/ Adjustable Plastic Bullet Feet
- Selected Models Feature Adjustable Galvanized Cross-Bracing (Front to Back)
- Embossed & Seamless Drainboards (Where Applies)
- Blender Stations Include Hidden Duplex Electrical Outlet



# UNDERBAR DROP-INS



## Drop-In Ice Bins, Water Stations & Hand Sinks

### DROP-IN WATER STATIONS

Includes K-54 Deck Mount Faucet With "Push-Back" Acrylic Lever Arm



**Ice Bin Inside Dim.:**  
8" x 13 1/2" x 10 13/16"  
**Ice Capacity:** 23 lbs.

**Ice Bin Inside Dim.:**  
13 1/2" x 18 3/4" x 10 13/16"  
**Ice Capacity:** 50 lbs.

### Underbar Basics™

For Custom Cut-Out Use  
Model # TA-34 \$355



**Overall Size:**  
12" x 14"

#### D-24-WSIBL \$2067

Removable Grate Covers Drip Pan  
13" Deep Insulated Ice Bin w/ S/S Steel Cover  
1" IPS Drain  
Outside Dim. 21" x 18"  
Cut-Out Size: 20 5/8" x 15 1/4"  
30 lbs. 5 cu. Ft.

#### D-24-WSIBL2 \$2473

Removable Grate Covers Drip Pan  
13" Deep Insulated Ice Bin w/ S/S Steel Cover  
1" IPS Drain  
Outside Dim.: 18" x 21"  
Cut-Out Size: 15 1/4" x 20 5/8"  
47 lbs. 5 cu. Ft.

Add A 7-Circuit Cold Plate  
To D-24-WSIBL2  
Add SU-49 \$2713

#### DI-1-9 \$1539

Removable Electro-Polished  
Stainless Steel Grill  
1 1/2" IPS Basket Drain  
Cut-Out Size: 11 1/4" x 13 1/4"  
15 lbs. 3 cu. Ft.

### DROP-IN BAR HAND SINKS

Featuring Deep Drawn Sink Bowls



**Overall Size:**  
13" x 19"

SPACE SAVER



**Overall Size:**  
12" x 14"



Includes  
Sliding  
Stainless Steel  
Cover

**Hand Sink Bowl Size:**  
9" x 9" x 4"

**Ice Bin Inside Dim.:**  
8" x 13 1/2" x 10 13/16"

**Ice Capacity:** 23 lbs.

#### DI-1-5 \$866

K-52 Deck Mounted Faucet  
1 1/2" IPS Basket Drain  
Cut-Out Size: 12 1/4" x 18 1/4"  
20 Gauge Stainless Steel  
12 lbs. 2 cu. Ft.

#### DI-1-25 \$965

K-52 Deck Mounted Faucet  
1 1/2" IPS Basket Drain  
Cut-Out Size: 11 1/4" x 13 1/4"  
20 Gauge Stainless Steel  
8 lbs. 2 cu. Ft.

#### D-24-SIBL \$2209

K-51 Deck Mounted Faucet  
Insulated Ice Bin w/ S/S Cover  
1" IPS Drain In Ice Bin  
Outside Dim.: 21" x 18"  
Cut-Out Size: 20 5/8" x 15 1/4"  
Factory Installed Only  
20 Gauge Galvanized Steel  
30 lbs. 5 cu. Ft.

For Our Full Line Of Drop-in Sinks, See pages 3-5

## ACCESSORIES & MODIFICATIONS

### Replacement Sliding Stainless Steel Covers

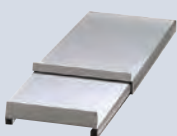

D-12  
Shown

Model #	Price	For Use With:
D-12	\$246	D-12-IBL, D-24-WSIBL, D-24-WSIBL2, D-24-SIBL
D-24	381	D-24-IBL, D-24-IBL-7
D-24V	339	D-24-IBL, D-24-IBL-7
D-30	334	Units oriented with 18" dimension left-to-right D-30-IBL, D-30-IBL-7
D-36	365	D-36-IBL, D-36-IBL-7

Cover designed to open front-to-rear, with 18" ice bin dimension front-to-rear.  
(D-24-WSIBL2 opens left to right when installed with 21" front-to-rear)



Add Wrist Handles  
K-316-LU  
\$175

### Water Filler Faucets

K-54 8-1/4" High \$781  
K-54A 12" High \$887  
K-54OMIT -\$300  
Omit K-54 Faucet



6" Deck  
Mounted Faucet  
K-51 \$696  
4" O.C.



3 1/2" Gooseneck  
Deck Mounted Faucet  
K-52 \$348



# UNDERBAR DROP-INS

## Drop-In Ice Bins, Bar Sinks, Drain Pans & Glass Rinsers

### Underbar Basics™

- Rubber Thermal Breaker Reduces Condensation
- Optional 7-Circuit Cold Plate Sealed Into The Bottom

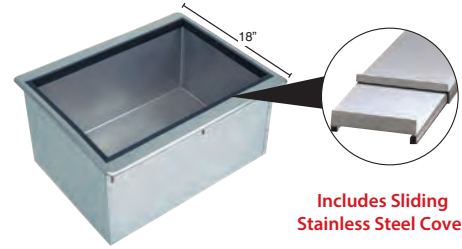

Includes Sliding Stainless Steel Cover

For Replacement Sliding Stainless Steel Covers, See Page 96.

## DROP-IN ICE BINS

11" Deep Insulated Ice Bin w/ Sliding Stainless Steel Cover

Model #	Price	Overall Length	Cut Out Size W x L	Ice Capacity	Approx. Weight	Approx. Cu. Ft.
D-12-IBL	\$1658	12"	15 1/4" x 9 5/8"	23 lbs.	22 lbs.	3
D-24-IBL	1818	21"	15 1/4" x 20 3/8"	50 lbs.	39 lbs.	5
D-30-IBL	1840	27"	15 1/4" x 26 3/8"	62 lbs.	62 lbs.	8
D-36-IBL	2055	33"	15 1/4" x 32 3/8"	75 lbs.	67 lbs.	9
w/ 7-CIRCUIT COLD PLATE						
D-24-IBL-7	4138	21"	15 1/4" x 20 3/8"	50 lbs.	84 lbs.	9
D-30-IBL-7	4191	27"	15 1/4" x 26 3/8"	62 lbs.	107 lbs.	13
D-36-IBL-7	4387	33"	15 1/4" x 32 3/8"	75 lbs.	113 lbs.	15

## DROP-IN BAR SINKS

Optional Built-in Embossed Drainboard

- 10" x 14" x 10" Sink Bowls
- 9" High Overflow Pipe(s) w/ 1 1/2" IPS Drain(s)
- 4" O.C. Deck Mounted Swing Faucet
- 4" O.C. Deck Mounted Faucet

Model #	Price	# of Bowls	# of Drbds.	Drbd. Size	Drbd. Location	Outside Dim. W x L	Cut Out Size W x L	Approx. Weight	Approx. Cu. Ft.
DBS-1	\$1268	1	0	N/A	N/A	13" x 19"	12 1/4" x 18 1/4"	21 lbs.	3
DBS-2	1423	2	0	N/A	N/A	25 1/2" x 19"	24 3/4" x 18 1/4"	26 lbs.	4
DBS-3	1713	3	0	N/A	N/A	38" x 19"	37 1/4" x 18 1/4"	42 lbs.	9
DBS-43L	2580	3	1	12"	Right	21 1/8" x 48 5/16"	17" x 47"	88 lbs.	10
DBS-43R	2750	3	1	12"	Left	21 1/8" x 48 5/16"	17" x 47"	88 lbs.	10
DBS-53C	2750	3	2	12"	Left & Right	21 1/8" x 60 5/16"	17" x 59"	100 lbs.	21
DBS-63C	2933	3	2	18"	Left & Right	21 1/8" x 72 5/16"	17" x 71"	110 lbs.	24

L and R Indicate Sink Location. C Indicates Sink is Centered.



DBS-1

DBS-53C shown

## 18" WIDE COUNTERTOP DRAIN PAN

- Removable Drip Tray
- Stainless Steel Top
- 1/2" NPT Drain

CUSTOM SIZES AVAILABLE  
Consult Factory For Details

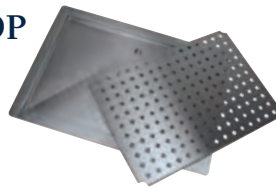

Model #	Price	Size W x L	Cut Out Size	Approx. Weight	Approx. Cu. Ft.
DP-1818	\$1169	18" x 18"	15 3/4" x 15 3/4"	18 lbs.	2
DP-1824	1194	18" x 24"	15 3/4" x 21 3/4"	23 lbs.	2
DP-1830	1220	18" x 30"	15 3/4" x 27 3/4"	28 lbs.	3
DP-1836	1262	18" x 36"	15 3/4" x 33 3/4"	33 lbs.	3
DP-1842	1358	18" x 42"	15 3/4" x 39 3/4"	38 lbs.	4
DP-1848	1464	18" x 48"	15 3/4" x 45 3/4"	43 lbs.	4

## BAR DRINK RAILS

- Type 300 Stainless Steel
- 8" Wide (Front To Back) x 3/4" Deep
- Perforated Removable Grate Allows For Easy Cleaning
- 1" Drain On Right Side
- Designed To Secure To Underside Of Wood Substrate



Model #	Price	Size W x L	Approx. Weight	Approx. Cu. Ft.
DRKR-12	\$424	8" x 12"	10 lbs.	2
DRKR-18	471	8" x 18"	15 lbs.	2
DRKR-24	497	8" x 24"	20 lbs.	2
DRKR-30	570	8" x 30"	25 lbs.	2
DRKR-36	632	8" x 36"	30 lbs.	3
DRKR-42	716	8" x 42"	35 lbs.	3
DRKR-48	805	8" x 48"	40 lbs.	3

### OPTIONS

- DRKC-45-IC  
45° Inside Corner
- DRKC-45-OC  
45° Outside Corner  
**\$790 ea.**
- DRKC-90-IC  
90° Inside Corner
- DRKC-90-OC  
90° Outside Corner  
**\$790 ea.**

## COUNTERTOP GLASS RINSER

Rinses away any impurities that might be in the glass!

- Mounts Easily to countertop or bar equipment
- Brushed Stainless Steel
- Water Rinsers And Glass Actuator  
By Pushing Down On Glass
- Threaded Drain For 1/2" Drain Hose



SU-16

Model #	Price	Size	Approx. Wt	Approx. Cu. Ft.
SU-16	808	6 3/8" x 6 3/8" x 3/4"	7 lbs.	1

## GLASS RINSER FOR PERFORATED DRAINBOARDS (Activator Only) **FACTORY INSTALLED ONLY**

SU-16P	\$600	4 1/4" Diameter	3 lbs.	1
--------	-------	-----------------	--------	---



SU-16P

## UNDERCOUNTER GLASS RINSER

Rinses away any impurities that might be in the glass!

- Mounts Easily to Underside Of Wood Substrate
- Brushed Stainless Steel
- Retrofit any liquid dispense station
- Water Rinsers And Glass Actuator  
By Pushing Down On Glass
- Threaded Drain For 1/2" Drain Hose



SU-16UM

Model #	Price	O.A. W x L x H	Rinsers Size W x L x H	Approx. Wt	Approx. Cu. Ft.
SU-16UM	\$900	6 3/8" x 11 3/8" x 1"	6-3/8" x 6-3/8" x 1"	8 lbs.	1

**WARNING:** Faucets on this page may expose you to chemicals, including lead, that are known to the State of California to cause cancer or birth defects or other reproductive harm. For more info, visit [www.p65warnings.ca.gov](http://www.p65warnings.ca.gov).

# BAR HAND SINKS

## Free Standing Bar Hand/Dump Sinks

Underbar **Basics™**



### BAR HAND SINKS

Bowl Size: 10" x 14" x 7" • 29" Working Height • 4" High Backsplash  
Includes 1-1/2" IPS Drain & Galvanized Legs w/ Adjustable Galvanized Side Cross-Bracing & Adjustable Plastic Bullet Feet  
Add SU-10A For Stainless Steel Leg & Stainless Steel Bullet Foot Upgrade w/ Front-to-Back Cross-Bracing **\$378**



#### 18" Wide Units

- 4" O.C. Splash Mounted Swing Spout Faucet

Model #	Price	Overall Length	Approx. Weight	Approx. Cu. Ft.
SL-HS-12	<b>\$1404</b>	12"	31 lbs.	5
SL-HS-15	<b>1490</b>	15"	34 lbs.	6



#### 21" Wide Units

- 4" O.C. Deck Mounted Swing Spout Faucet
- Rear Deck For Extra Storage

Model #	Price	Overall Length	Approx. Weight	Approx. Cu. Ft.
CR-HS-12	<b>\$1454</b>	12"	32 lbs.	6
CR-HS-15	<b>1531</b>	15"	35 lbs.	6

## HAND SINKS w/ BUILT-IN SOAP & TOWEL DISPENSERS

Bowl & Faucet • 29" Working Height • 4" High Backsplash  
Includes 1 1/2" IPS Basket Drain & Galvanized Legs w/ Adjustable Galvanized Side Cross-Bracing & Adjustable Plastic Bullet Feet  
Add SU-10C For Stainless Steel Leg & Stainless Steel Bullet Foot Upgrade w/ Front-to-Back Cross-Bracing **\$378**



#### 21" Wide Standard Units

- 4" O.C. Deck Mounted Swing Spout Faucet
- Rear Deck For Extra Storage

Model #	Price	Overall Length	Approx. Weight	Approx. Cu. Ft.
SC-12-TS	<b>\$1820</b>	12"	45 lbs.	4
SC-15-TS	<b>1866</b>	15"	49 lbs.	4



#### 21" Wide Side Splash Units

- 4" O.C. Deck Mounted Swing Spout Faucet
- 4" High Stainless Steel Side Splashes
- Rear Deck For Extra Storage

Model #	Price	Overall Length	Approx. Weight	Approx. Cu. Ft.
SC-12-TS-S	<b>\$2277</b>	12"	50 lbs.	4
SC-15-TS-S	<b>2330</b>	15"	54 lbs.	4

**18" Wide Units Available - Consult Factory**

## HAND SINK ACCESSORIES & MODIFICATIONS



#### Add Wrist Handles

K-316-LU **\$175**

For Deck & Splash Mount Faucets



#### Replacement Deck Mount Soap Dispenser

K-12 **\$222**



#### Chrome Towel Ring

A-15 **\$143** Packed Loose



#### Replacement 6" Splash

Mount Faucet

K-125 **\$454**

4" O.C. 6" Spout

#### Add A Side Splash

SU-18R or L **\$240**

SU-18RL **\$486**

For 21" Wide Units

SU-21R or L **\$263**

SU-21RL **\$520**



#### Stainless Steel Leg Upgrade

- Includes 2 Sets of (2) S/S Legs w/ Adjustable S/S Bullet Feet & Adjustable S/S Front-to-Back Cross-Bracing

- Leg Heights Do Not Include 1 1/4" Bullet Foot Height

SU-10A **\$378** 18" Legs

SU-10C **\$378** 14" Legs



#### Replacement 6" Deck

Mount Faucet

K-51 **\$663**

4" O.C. 6" Spout

For Our Full Line Of Modifications & Accessories, See Page 118-120.

### BAR SINKS

w/ 10" x 14" x 10"

- 4" High Backsplash
- 29" working Height
- Molded Apron For Extra Durability
- Each Sink Bowl Includes an Overflow Pipe w/ 1 1/2" IPS Drain
- Galvanized Legs w/ Adjustable Galvanized Side Cross-Bracing & Adjustable Plastic Bullet Feet

- **SLB Series** Includes 1 - 4" O.C. Splash Mounted Swing Spout Faucet
- **CRB Series** Includes 1 - 4" O.C. Deck Mounted Swing Spout Faucet & Has Rear Deck For Extra Storage
- **4 Comp. Sinks** Include Two 6" Swing Spout Faucets



**SLB Series**  
18" Wide Units With  
Splash Mount Faucet



**CRB Series**  
21" Wide Units With  
Deck Mount Faucet



L And R Indicate Sink Location. C Indicates Sink Is Centered.

	SPLASH MOUNT FAUCET				DECK MOUNT FAUCET				O.A. Length	# of Drbds.	Drbd. Length	Approx. Cu. Ft.
	18" WIDE	Price	Spout Size	Approx. Wt.	21" WIDE	Price	Spout Size	Approx. Wt.				
<b>1 COMP.</b>	SLB-31C	\$2133	6"	55 lbs.	CRB-31C	\$2351	6"	55 lbs.	36"	2	12"	13
<b>2 COMP.</b>	SLB-22C	2252	6"	54 lbs.	CRB-22C	2424	6"	54 lbs.	24"	0	N/A	8
	SLB-32LorR	2391	6"	57 lbs.	CRB-32LorR	2550	6"	57 lbs.	36"	1	9"	13
	SLB-42LorR	2450	6"	62 lbs.	CRB-42LorR	2625	6"	62 lbs.	48"	1	21"	15
	SLB-42C	2450	6"	66 lbs.	CRB-42C	2646	6"	66 lbs.	48"	2	12"	15
<b>3 COMP.</b>	SLB-33C	2583	10"	65 lbs.	CRB-33C	2759	12"	65 lbs.	36"	0	N/A	13
	SLB-43LorR	2715	10"	68 lbs.	CRB-43LorR	2905	12"	68 lbs.	48"	1	9"	15
	SLB-53C	2857	10"	76 lbs.	CRB-53C	3059	12"	76 lbs.	60"	2	12"	18
	SLB-63C	3012	10"	88 lbs.	CRB-63C	3224	12"	88 lbs.	72"	2	18"	22
	SLB-73C	3350	10"	162 lbs.	CRB-73C	3584	12"	170 lbs.	84"	2	24"	39
<b>4 COMP.</b>	SLB-83C	3660	10"	183 lbs.	CRB-83C	3928	12"	191 lbs.	96"	2	30"	44
	SLB-64C*	3556	6"	92 lbs.	CRB-64C*	3788	6"	92 lbs.	72"	2	12"	22
	SLB-74C*	3783	6"	164 lbs.	CRB-74C*	4046	6"	172 lbs.	84"	2	18"	39
	SLB-84C*	4111	6"	185 lbs.	CRB-84C*	4377	6"	193 lbs.	96"	2	24"	44

\*4 Comp. Bar Sinks Include 2 - 6" Swing Spout Faucets

### BAR SINK & ICE BIN COMBO

With Removable Plastic Bottle Racks

- 4" Backsplash
- 29" Working Height
- Three or Four Compartment - 10" x 14" Bowls
- Each Sink Bowl Includes Overflow Pipe & 1-1/2" I.P.S. Drain
- Molded Apron For Extra Durability
- 24" x 15" x 8" Insulated Ice Bin; 54 lbs. Ice Capacity
- Ice Bin Includes 1" IPS Drain
- Galvanized Legs w/ Adjustable Galvanized Side Cross-Bracing & Adjustable Plastic Bullet Feet
- **SLC Series** Includes 1 - 4" O.C., 10" Splash Mounted Swing Spout Faucet
- **CRC Series** Includes 1 - 4" O.C., 12" Deck Mounted Swing Spout Faucet & Has Rear Deck For Extra Storage



SLC-83C-R

Add A 7-Circuit Cold Plate  
To SLC or CRC series  
Add SU-49 \$2713

L And R Indicates Ice Bin Location.

SPLASH MOUNT FAUCET		DECK MOUNT FAUCET		O.A. Length	# of Bowls	# of Drbds.	Drbd. Length	Approx. Weight	Approx. Cu. Ft.
18" WIDE	Price	21" WIDE	Price						
SLC-73C-LorR	\$3866	CRC-73C-LorR	\$4132	84"	3	2	12"	185 lbs.	28
SLC-83C-LorR	4008	CRC-83C-LorR	4274	96"	3	2	18"	225 lbs.	32
SLC-84C-LorR*	4488	CRC-84C-LorR*	4785	96"	4	2	12"	225 lbs.	32

\*4 Comp. Bar Sinks Include 2 - 6" Swing Spout Faucets

### BAR SINK MODIFICATIONS

#### Add A Side Splash

For 18" Wide Units  
SU-18R or L **\$240**  
SU-18RL **\$486**

For 21" Wide Units  
SU-21R or L **\$263**  
SU-21RL **\$520**

#### Stainless Steel Leg Upgrade

- Includes 2 Sets of (2) S/S Legs w/ Adj. S/S Bullet Feet & Adj. S/S Front-to-Back Cross-Bracing
- Leg Heights Do Not Include 1 1/4" Bullet Foot Ht.

SU-10A **\$378**  
18" Legs

For Our Full Line Of Speed Rails, See Page 101.

# ICE BINS

## Ice Bins

All Bottle Racks Must Be Removed For NSF Compliance & For Use With Optional Cover

Underbar **Basics™**

Quick Pour Bottles Not Included

### 12" or 16" Deep Insulated Ice Bins • 29" Working Height

- 4" Backsplash
- Includes Two Removable Plastic Bottle Racks
- Galvanized Legs w/ Adjustable Galvanized Side Cross-Bracing & Adjustable Plastic Bullet Feet
- **CRI Series** Has Rear Deck For Extra Storage
- Optional 7or 10 Circuit Cold Plate Sealed Into The Bottom



**SLI Series**  
18" Wide Units



**CRI Series**  
21" Wide Units

Ice Bin Depth	O.A.	Ice Bin Capacity	18" WIDE	Price	Approx. Wt.	21" WIDE	Price	Approx. Wt.	Approx. Cu. Ft.
<b>12" DEEP</b>	12"	35 lbs.	SLI-12-12	\$1535	46 lbs.	CRI-12-12	\$1558	50 lbs.	6
	24"	77 lbs.	SLI-12-24	1801	60 lbs.	CRI-12-24	1920	65 lbs.	8
	30"	98 lbs.	SLI-12-30	1990	68 lbs.	CRI-12-30	2183	72 lbs.	11
	36"	119 lbs.	SLI-12-36	2175	78 lbs.	CRI-12-36	2331	80 lbs.	12
	42"	140 lbs.	SLI-12-42	2275	84 lbs.	CRI-12-42	2427	90 lbs.	13
<b>16" DEEP</b>	48"	161 lbs.	SLI-12-48	2377	90 lbs.	CRI-12-48	2533	98 lbs.	14
	24"	100 lbs.	SLI-16-24	2306	69 lbs.	CRI-16-24	2479	72 lbs.	8
	30"	127 lbs.	SLI-16-30	2567	78 lbs.	CRI-16-30	2756	82 lbs.	12
36"	155 lbs.	SLI-16-36	2830	86 lbs.	CRI-16-36	3032	90 lbs.	17	
<b>w/ 7-CIRCUIT COLD PLATE</b>									
<b>12" DEEP</b>	24"	77 lbs.	SLI-12-24-7	3691	119 lbs.	CRI-12-24-7	3813	122 lbs.	8
	30"	128 lbs.	SLI-12-30-7	3882	133 lbs.	CRI-12-30-7	4017	136 lbs.	11
	36"	149 lbs.	SLI-12-36-7	4065	144 lbs.	CRI-12-36-7	4220	147 lbs.	13
	42"	170 lbs.	SLI-12-42-7	4164	157 lbs.	CRI-12-42-7	4316	163 lbs.	13
<b>16" DEEP</b>	48"	191 lbs.	SLI-12-48-7	4268	169 lbs.	CRI-12-48-7	4329	175 lbs.	14
	24"	100 lbs.	SLI-16-24-7	4193	128 lbs.	CRI-16-24-7	4367	136 lbs.	8
	30"	127 lbs.	SLI-16-30-7	4453	140 lbs.	CRI-16-30-7	4649	143 lbs.	12
36"	155 lbs.	SLI-16-36-7	4724	153 lbs.	CRI-16-36-7	4925	59 lbs.	17	
<b>w/ 10-CIRCUIT COLD PLATE</b>									
<b>12" DEEP</b>	30"	98 lbs.	SLI-12-30-10	5565	165 lbs.	CRI-12-30-10	5034	69 lbs.	11
	36"	119 lbs.	SLI-12-36-10	5981	177 lbs.	CRI-12-36-10	5173	181 lbs.	12
	42"	140 lbs.	SLI-12-42-10	5170	186 lbs.	CRI-12-42-10	5430	191 lbs.	13
<b>16" DEEP</b>	48"	161 lbs.	SLI-12-48-10	5390	201 lbs.	CRI-12-48-10	5625	206 lbs.	14
	30"	127 lbs.	SLI-16-30-10	5565	174 lbs.	CRI-16-30-10	5998	180 lbs.	12
36"	155 lbs.	SLI-16-36-10	5981	185 lbs.	CRI-16-36-10	6351	192 lbs.	17	

## INSULATED BOTTLE STORAGE BIN

### Featuring 12" Deep Insulated Ice Bin

- 4" Backsplash
- 29" working height
- Includes Two 3-Pack Plastic Bottle Racks
- Galvanized Legs w/ Adjustable Galvanized Side Cross-Bracing & Adjustable Plastic Bullet Feet
- 1" I.P.S. Drain

18" WIDE			21" WIDE					
Model #	Price	Approx. Weight	Model #	Price	Approx. Weight	L	Ice Bin Capacity	Approx. Cu. Ft.
SLI-12-12	\$1535	46 lbs.	CRI-12-12	\$1558	50 lbs.	12"	35 lbs.	6

Quick Pour Bottles Not Included



SLI-12-12

## PORTABLE ICE BIN 16" Extra Deep For Beer Bottle Storage

- Insulated Ice Bin
- 29" working height
- Stainless Steel Welded Cross-Braced Legs w/ Casters (2 w/ Brakes)
- 1" IPS Drain w/ Shut Off Valve

Model #	Price	Size L x W x H	Ice Bin Capacity	Approx. Weight	Approx. Cu. Ft.
SCI-MIC-24	\$2085	24" x 18 3/4" x 29"	100 lbs.	120 lbs.	7
SCI-MIC-30	2176	30" x 18 3/4" x 29"	127 lbs.	130 lbs.	12
SCI-MIC-36	2336	36" x 18 3/4" x 29"	155 lbs.	145 lbs.	16

**18 3/4" WIDE**



## ICE BIN ACCESSORIES & MODIFICATIONS

### Sliding Stainless Steel Covers For Ice Bins

For SLI & CRI Series

SSC-12	For 12" Ice Bin	\$252
SSC-24	For 24" Ice Bin	281
SSC-30	For 30" Ice Bin	312
SSC-36	For 36" Ice Bin	334
SSC-42	For 42" Ice Bin	381
SSC-48	For 48" Ice Bin	393



For Older Style Ice Bins Prior to 2015

SSC-24	For 24" Ice Bin	\$281
SSC-29	For 30" Ice Bin	341
SSC-35	For 36" Ice Bin	362

### Stainless Steel Leg Upgrade

Includes 2 Sets of (2) S/S Legs w/ Adj. S/S Bullet Feet & Adj. S/S Front-to-Back Cross-Bracing

SU-10B	10" legs (16" Deep Ice Bins)	\$364
SU-10C	14" legs (12" Deep Ice Bins) Leg Heights Do Not Include 1 1/4" Bullet Foot Height	378

### Stainless Steel Ice Bin Partitions

A-38	8" High x 14 3/4" Wide Partition	183
A-39	12" High x 14 3/4" Wide Partition	183
A-40	16" High x 14 3/4" Wide Partition	183
SU-24	Provision To Connect Underbar Equipment (Price Per Every 2 Units)	209
SU-30	Soda Chase Provision (Tip-Out) (Only For Ice Bins w/Backsplash)	669

**NSF** All Drainboards Are NSF Approved



SLD-3

- Embossed & Seamless Drainboard
- 4" Backsplash
- Galvanized Legs w/ Adjustable Galvanized Side Cross-Bracing & Adjustable Plastic Bullet Feet
- 1" IPS Drain
- **CRD Series** Has Rear Deck For Extra Storage

### FREE-STANDING BAR DRAINBOARDS 29" Working Height

Overall Length	18" WIDE			21" WIDE				
	Model #	Price	Approx. Weight	Cu. Ft.	Model #	Price	Approx. Weight	Cu. Ft.
12"	SLD-12	\$973	26 lbs.	7	CRD-12	\$1087	28 lbs.	8
18"	SLD-18	1071	29 lbs.	7	CRD-18	1225	30 lbs.	8
24"	SLD-2	1251	35 lbs.	7	CRD-2	1330	39 lbs.	8
30"	SLD-30	1326	40 lbs.	10	CRD-30	1508	41 lbs.	12
36"	SLD-3	1453	42 lbs.	10	CRD-3	1596	47 lbs.	12
48"	SLD-4	1722	55 lbs.	12	CRD-4	1855	51 lbs.	16

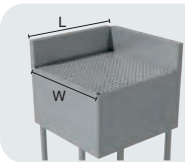

#### MAKE 24" CORNER DRAINBOARDS

Add to SLD-2 or CRD-2 Drainboards Only

Model #	Price	W x L
SU-1824R or L	\$315	18" x 24"
SU-2124R or L	351	21" x 24"

Add SU-40 To Prep Unit For Speed Rail Installation - **\$128**

### RECESSED BAR DRAINBOARDS

Holds Multiple Tiers Of Glasses • 23 1/2" Working Height



SL-GS-12 Shown  
23" Wide Units



CR-GS-18 shown  
26" Wide Units

- Includes Four Galvanized Legs w/ Adjustable Galvanized Side Cross-Bracing & Adjustable Plastic Bullet Feet
- Embossed And Seamless Drainboard
- 1" IPS Drain Centered In Drainboard
- **CR-GS Series** Has Rear Deck For Extra Storage

Overall Length	23" WIDE			26" WIDE				
	Model #	Price	Approx. Weight	Cu. Ft.	Model #	Price	Approx. Weight	Cu. Ft.
12"	SL-GS-12	\$907	20 lbs.	6	CR-GS-12	\$1031	20 lbs.	6
15"	SL-GS-15	958	22 lbs.	6	CR-GS-15	1052	22 lbs.	6
18"	SL-GS-18	1043	24 lbs.	7	CR-GS-18	1130	24 lbs.	8
24"	SL-GS-24	1164	28 lbs.	7	CR-GS-24	1290	28 lbs.	8

### FROZEN DRINK MACHINE STANDS

10-1/2" Working Height



SCFD-18



Creased surface to allow liquids to flow towards rear center drain

- 14" Backsplash
- Features A Lower Working Height To Accommodate The Height Of Most Drink Machines For Underbar Use
- Beveled Front
- Drain Centered In Back Of Unit
- Galvanized Legs w/ Adjustable Plastic Bullet Feet
- Adjustable Galvanized Side Cross-Bracing

#### SCFD-18 \$1950

18" x 28" x 33"  
Holds One Drink Machine  
45 lbs. 10 Cu. Ft.

# BLENDER STATIONS

## Blender Stations & Uni-Serv Speed Bar

Underbar **Basics™**

### BLENDER STATIONS

Includes Four Galvanized Legs w/ Adjustable Plastic Bullet Feet  
Featuring Adjustable Galvanized Side Cross-Bracing  
All Faucets Meet Federal Lead Free Standards



All Blender Stations Include A  
15A - 120V GFI Duplex Receptacle  
Hidden Beneath Blender Shelf

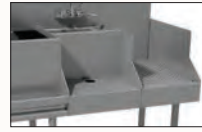

**WANT US TO CONNECT IT?**  
Add SU-24

Price Per Every Two Units **\$209**



### w/ Dump Sink & Faucet

- Dump Sink
- 4" Backsplash
- 15A - 120V GFI Duplex Outlet Hidden Beneath Shelf
- Recessed Step For Blenders
- Grommet Hole For Blender Power Cords
- 1" IPS Drain
- **SL-RS Series** Includes 4" O.C. Splash Mounted Swing Spout Faucet
- **CR-RS Series** Includes 4" O.C. Deck Mounted Swing Spout Faucet And Has Rear Deck For Extra Storage

**SL-RS Series**  
23" Wide Units With  
Splash Mount Faucet

**CR-RS Series**  
26" Wide Units With  
Deck Mount Faucet

Overall Length	23" WIDE	Price	Approx. Weight	Approx. Cu. Ft.	26" WIDE	Price	Approx. Weight	Approx. Cu. Ft.
12"	<b>SL-RS-12</b>	<b>\$1628</b>	20 lbs.	6	<b>CR-RS-12</b>	<b>\$1698</b>	21 lbs.	6
18"	<b>SL-RS-18</b>	<b>1866</b>	23 lbs.	6	<b>CR-RS-18</b>	<b>1945</b>	23 lbs.	6

### BLENDER STATION ACCESSORIES & MODIFICATIONS

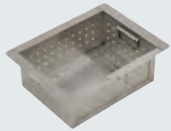

A-16



A-17

- A-15 Chrome Towel Ring (Packed Loose) ..... **\$143**
- A-16 Perforated Basket (Fits 10" x 14" x 7" & 10" x 14" x 10" Sinks) ..... **358**
- A-17 Perforated Basket (Fits 9-1/2" x 11-1/2" x 6 Sink) ..... **351**
- K-316-LU Add Wrist Handles ..... **175**
- SU-10A 18" Stainless Steel Leg Upgrade (Set of 4 -Includes Adjustable Front-to-Back Cross-Bracing) ..... **378**

6" Stainless Steel Open Waste Chute  
Fits 6" Dia. Cutout

A-6  
**\$191**



Dipper Well Faucet

A-33  
**\$235**



6" Dipper Well with Insert and Drain  
Fits 6" Dia. Cutout

A-7  
**\$500**



Water Filler Faucet

K-54  
8-1/4" High **\$781**  
K-54A  
13" High **\$887**



Add **SU-34** Cutout for A6 or A-7  
**\$142**

### UNI-SERV SPEED BAR

12" Deep Ice Bin w/ Dump Sink, Recessed Drainboard & Blender Station • 29" Working Height

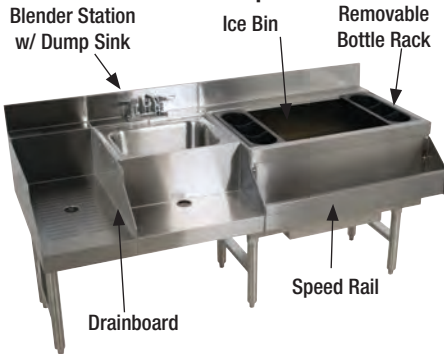

**CRU-60R Shown**

- 4" Backsplash
- 26" Front To Back
- SRK-30 - 30" Speed Rail
- 30" Insulated Ice Bin
- 98 lbs. Ice Bin Capacity
- Two Removable Plastic Bottle Racks
- Optional 7-Circuit Cold Plate Sealed Into The Bottom Of Ice Bin
- Dump Sink
- 4" O.C. Deck Mounted Swing Spout Faucet
- Recessed Drainboard for Glassware
- Dual Blender/Mixer Recess
- Galvanized Legs w/ Adjustable Plastic Bullet Feet & Adjustable Galvanized Side Cross-Bracing



15A - 120V GFI Duplex  
Receptacle Hidden  
Beneath Blender Shelf

Model #	Price	Overall Length	Approx. Weight	Approx. Cu. Ft.
<b>CRU-60L or R</b>	<b>\$5073</b>	60"	110 lbs.	23
<b>w/ 7-CIRCUIT COLD PLATE</b>				
<b>CRU-60L-7 or R-7</b>	<b>7111</b>	60"	193 lbs.	23

*L And R Indicate Ice Bin Location.*

### BEER BOX

18" Deep • 29" Working Height

- Perforated False Bottom Allows Melted Ice To Drain
- False Bottom Is Removable For Easy Cleaning
- 4" Backsplash
- Stainless Steel Legs w/ Adjustable Stainless Steel Bullet Feet
- 1" I.P.S. Drain



CRBB-48

Model #	Price	Overall Length	Ice Bin Liner Size W x L x H	Capacity of Bottled Beer	Approx. Weight	Approx. Cu. Ft.
CRBB-48	<b>\$3335</b>	48"	20 3/4" x 45 3/4" x 18"	12 cases	220 lbs.	14
CRBB-60	<b>3569</b>	60"	20 3/4" x 57 3/4" x 18"	18 cases	225 lbs.	15

### BEER BOX COVERS

Includes Two Padded Locks & Keys



*Beer Box Covers Must Be Removed During Normal Operation*

Model #	Description	Price
SU-35A	For 48" Beer Box	<b>\$1047</b>
SU-35B	For 60" Beer Box	<b>1316</b>

Add SU-55 For Stainless Steel Divider add **\$252 ea.**

### LIQUOR DISPLAYS NSF

Tiered Steps & Retaining Bars Securely Display Liquor Bottles



LD-1824

### Liquor Display Rack

- Sound Deadened
- 5 Steps
- 4" Backsplash
- Galvanized Legs w/ Adjustable Plastic Bullet Feet
- Adjustable Galvanized Side Cross-Bracing
- 26" Wide Units Have Rear Deck For Extra Storage



CRLR-24

### Liquor Display Cabinet

- Stainless Steel Cabinet
- 5 Steps
- 4" Backsplash
- Stainless Steel Legs w/ Adjustable Bullet Feet

	Model #	Price	Overall Length	Approx. Bottle Capacity	Approx. Weight	Approx. Cu. Ft.
26" DEPTH	LD-1812	<b>\$1491</b>	12"	12	30 lbs.	15
	LD-1818	<b>1649</b>	18"	20	35 lbs.	20
	LD-1824	<b>1993</b>	24"	28	40 lbs.	30
23" DEPTH	LD-2112	<b>1630</b>	12"	12	30 lbs.	15
	LD-2118	<b>1840</b>	18"	20	35 lbs.	20
	LD-2124	<b>2088</b>	24"	28	40 lbs.	30

	Model #	Price	Overall Length	Approx. Bottle Capacity	Approx. Weight	Approx. Cu. Ft.
21" DEPTH	CRLR-12	<b>\$1782</b>	12"	15	35 lbs.	7
	CRLR-18	<b>2074</b>	18"	20	36 lbs.	10
	CRLR-24	<b>2513</b>	24"	30	42 lbs.	13
	CRLR-30	<b>2586</b>	30"	35	47 lbs.	14
	CRLR-36	<b>2751</b>	36"	45	50 lbs.	15

### REMOVABLE STAINLESS STEEL LIQUOR DISPLAY COVERS

Includes Padlock & Two Keys. Factory Installed Only.

#### Display Rack Cover

For LD Models Only



	Length	Model #	Price
18" WIDE	12"	LC-1812	<b>\$754</b>
	18"	LC-1818	<b>836</b>
	24"	LC-1824	<b>921</b>
21" WIDE	12"	LC-2112	<b>812</b>
	18"	LC-2118	<b>896</b>
	24"	LC-2124	<b>1014</b>

#### Display Cabinet Cover

For CRLR Models Only



	Length	Model #	Price
21" WIDE	12"	LC-12	<b>\$912</b>
	18"	LC-18	<b>988</b>
	24"	LC-24	<b>1047</b>
	30"	LC-30	<b>1171</b>
	36"	LC-36	<b>1263</b>

For Speed Rails, See Page 105.

# BAR STORAGE

## Glassware Storage

Glass Racks Not Included • Approximate Weights & Cubes Listed



Underbar Basics™

## UNDERBAR STORAGE CABINETS

With Seamless & Embossed Drainboard Top

### Drainboard Cabinets

- 21" Width (Front to Back)
- 4" Backsplash
- 1" IPS Drain In Back Right Corner Of Top
- 3" Diameter Drain Hole In Upper Right Corner Of Back Panel
- Stainless Steel Legs w/ Adjustable Bullet Feet



**OPEN BASE**  
CRD-2B Shown



**w/ MID-SHELF**  
CRD-2BM Shown



**W/ MID-SHELF & DOOR**  
CRD-2BMD Shown

Size W x L x H	OPEN BASE		2 TIER STORAGE UNIT		2 TIER STORAGE UNIT WITH HINGED DOOR		Approx. Weight	Approx. Cu. Ft.
	Model #	Price	Model #	Price	Model #	Price		
21" x 24" x 33"	CRD-2B	<b>\$2147</b>	CRD-2BM	<b>\$2628</b>	CRD-2BMD	<b>\$2869</b>	59 lbs.	14
21" x 30" x 33"	CRD-30B	<b>2250</b>	CRD-30BM	<b>2758</b>	CRD-30BMD	<b>3009</b>	99 lbs.	18
21" x 36" x 33"	CRD-3B	<b>2501</b>	CRD-3BM	<b>3018</b>	CRD-3BMD	<b>3269</b>	140 lbs.	20
21" x 48" x 33"	CRD-4B	<b>2715</b>	CRD-4BM	<b>3233</b>	CRD-4BMD	<b>3449</b>	152 lbs.	20

### 24" Glass Rack Storage Unit



CRCR-24-CT

- 21" Width (Front to Back)
- 4" Backsplash
- Holds Up To 3 Glass Racks
- Stainless Steel Glass Rack Slides
- 1" IPS Drain In Back Right Corner Of Top
- 3" Diameter Drain Hole In Upper Right Corner Of Back Panel
- Stainless Steel Legs w/ Adjustable Bullet Feet

52 lbs. 13 Cu. Ft.

**CRCR-24 \$2174**

Flat Top - Drain Not Included

**CRCR-24-CT \$2239**

Corrugated Top

### Cabinet w/ Dump Sink & Waste Chute



- 21" x 18" x 33"
- Includes 1 Hinged Door
- 9" x 9" x 4" Dump Sink
- 4" O.C. Splash Mounted Swing Spout Lead Free Compliant Faucet
- 5 1/2" Diameter Waste Chute
- Stainless Steel Legs w/ Adjustable Bullet Feet

64 lbs. 15 Cu. Ft.

**CRDW-18 \$3800**

**Shown With Optional Door Lock and Wrist Handle Faucet**

## CABINET MODIFICATIONS & ACCESSORIES



**Add A Sink \$1382**

Splash Mount Faucet Included

**SU-22A 10" x 14" x 10" Bowl**

**SU-22C 9" x 9" x 4" Bowl**



**Add A Liquid Waste Chute With Filler Faucet**

**SU-36 \$1372**

- 5 1/2" Dia. Liquid Waste Chute
- Includes K-54 Push-Back Water Filler Faucet
- (Meets Federal Lead Free Standards)*



**Add A Door Lock**

**SU-27 \$474**

- Includes 2 Keys



**Add A Dipperwell Only**

**A-7 \$500**

- 5 1/2" Diameter
- 1-1/2" NPT Drain Connection
- Factory Installed. Includes TA-34 Cutout



**WANT US TO CONNECT IT?**

**Add SU-24 \$209**

Price Per Every Two Units

### STANDARD SPEED RAILS



#### Stainless Steel Speed Rails

- Keyhole Installation

SINGLE	Price	Size W x L x H	Bottle Capacity	Wt.	Cu. Ft.	DOUBLE	Price	Size W x L x H	Bottle Capacity	Wt.	Cu. Ft.
BK-15	\$150	4 1/2" x 15" x 5 1/2"	4	4 lbs.	1	DT-15	\$280	8 1/2" x 15" x 7"	8-10	7 lbs.	1
BK-2	152	4 1/2" x 24" x 5 1/2"	4-6	5 lbs.	1	DT-2	287	8 1/2" x 24" x 7"	10-12	8 lbs.	1
BK-30	169	4 1/2" x 30" x 5 1/2"	8-9	6 lbs.	1	DT-30	307	8 1/2" x 30" x 7"	16-18	10 lbs.	1
BK-3	176	4 1/2" x 36" x 5 1/2"	9-10	6 lbs.	1	DT-3	322	8 1/2" x 36" x 7"	18-20	11 lbs.	1
BK-4	215	4 1/2" x 48" x 5 1/2"	12-13	8 lbs.	1	DT-4	390	8 1/2" x 48" x 7"	24-26	18 lbs.	1

Single Tier  
BK-2 Shown



Double Tier  
DT-30 Shown



#### Black Plastic Speed Rails

- Injection Molded Black Plastic Construction
- Packed 6 Per Carton (Must Order Qty. of 6)
- Liquor Bottle Capacity = 5 Per Speed Rail

Model #	Price	Size W x L x H	Wt.	Cu. Ft.
KS-2K	\$84	4 1/8" x 23" x 5 3/8"	16 lbs.	2



KS-2K

Add Strap Hangers  
PR-STRAP \$71  
For KS-2K &  
BK Models Only



PR-STRAP

## HEAVY DUTY STAINLESS STEEL SPEED RAILS



Keyhole Installation

### Standard HD Speed Rails

SINGLE TIER  
SRK-2 Shown



DOUBLE TIER  
SRKD-18 Shown



SINGLE	Price	Size W x L x H	Cap.	DOUBLE	Price	Size W x L x H	Cap.	Wt. (lbs.)	Cu. Ft.
SRK-12	\$498	5 1/4" x 12" x 7 3/4"	3	SRKD-12	\$554	10 1/2" x 12" x 9 1/4"	6	8	1
SRK-15	503	5 1/4" x 15" x 7 3/4"	4	SRKD-15	561	10 1/2" x 15" x 9 1/4"	8	9	1
SRK-18	505	5 1/4" x 18" x 7 3/4"	4-5	SRKD-18	616	10 1/2" x 18" x 9 1/4"	8-10	10	1
SRK-2	536	5 1/4" x 24" x 7 3/4"	5-6	SRKD-2	716	10 1/2" x 24" x 9 1/4"	10-12	13	1
SRK-30	540	5 1/4" x 30" x 7 3/4"	7-8	SRKD-30	796	10 1/2" x 30" x 9 1/4"	14-16	16	1
SRK-3	542	5 1/4" x 36" x 7 3/4"	9-10	SRKD-3	784	10 1/2" x 36" x 9 1/4"	18-20	18	1
SRK-42	539	5 1/4" x 42" x 7 3/4"	11-12	SRKD-42	802	10 1/2" x 42" x 9 1/4"	22-24	20	2
SRK-4	548	5 1/4" x 48" x 7 3/4"	13-14	SRKD-4	845	10 1/2" x 48" x 9 1/4"	26-28	22	2
SRK-5	560	5 1/4" x 60" x 7 3/4"	15-18	SRKD-5	898	10 1/2" x 60" x 9 1/4"	30-36	26	2
SRK-6	587	5 1/4" x 72" x 7 3/4"	19-22	SRKD-6	965	10 1/2" x 72" x 9 1/4"	38-44	28	2
SRK-7	632	5 1/4" x 84" x 7 3/4"	23-26	SRKD-7	1057	10 1/2" x 84" x 9 1/4"	46-52	30	2
SRK-8	645	5 1/4" x 96" x 7 3/4"	27-28	SRKD-8	1112	10 1/2" x 96" x 9 1/4"	54-56	32	2

Make An Odd Length  
Speed Rail  
SU-41 \$101

Make Speed Rail Accommodate  
1/2 Gallon Bottles  
SU-42 \$134

### Hang-On Style

- Removable
- Hangs On First Tier Of Any SRK Series Speed Rail
- Increases Liquor Storage



SR-2H

Model #	Price	Size W x L x H	Cap.	Wt.	Cu. Ft.
SR-12H	\$370	6 1/4" x 12" x 8 1/2"	3	4 lbs.	1
SR-15H	379	6 1/4" x 15" x 8 1/2"	4	5 lbs.	1
SR-18H	389	6 1/4" x 18" x 8 1/2"	4-5	6 lbs.	1
SR-2H	395	6 1/4" x 24" x 8 1/2"	5-6	7 lbs.	1
SR-30H	414	6 1/4" x 30" x 8 1/2"	7-8	8 lbs.	1
SR-3H	432	6 1/4" x 36" x 8 1/2"	9-10	9 lbs.	1
SR-42H	444	6 1/4" x 42" x 8 1/2"	11-12	9 lbs.	2
SR-4H	451	6 1/4" x 48" x 8 1/2"	13-14	10 lbs.	2

Hang-On Style Speed Rails Are Not To Be Used  
With Any Other Manufacturer's Speed Rails

For Liquor Racks, See Page 99.



# PRESTIGE *Signature Series* MODULAR BAR DIE SYSTEM



Exclusively For Advance Tabco's Prestige Bar Equipment

## Bartender's Side Features:

- 20 Gauge, 302 Stainless steel
- Die Wall Can Be Sealed To The Floor, Eliminating Moisture In The Bar Structure.
- Recessed Equipment Outlets Allow Bar Equipment To Be Flush Against Bar Die Wall.
- GFI Outlets Set In Place (To Be Wired By Local Electrician To Meet Local Codes)
- Stainless Steel Panels Supplied Where Equipment By Others Is Located.
- Precise Engineering To Ensure An Exact Fit.
- Enclosed Casing For Beer Towers.
- Soda Gun Outlets Supplied (Location Must Be Specified).
- Cantilever System Made For Advance Tabco's Prestige Bar Equipment, Eliminating The Need For Legs.
- Pre-Defined Space For Plumbing And Drain Lines.

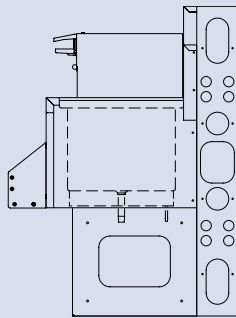

### Model # PR-BARDIE \$538 per ft.

Stainless Steel Exterior On Bar Side, Galvanized Upright Structure

### Model # PR-BARDIE-SS \$538 per ft.

Stainless Steel Exterior On Bar Side, Stainless Steel Upright Structure

- Replaces bar wall and helps organize electric and plumbing lines
- For new construction
- Cleanability
- Aesthetics / modern look

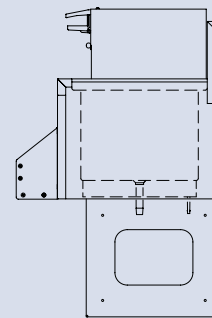

### Model # SU-PED \$184 per ft.

- Bolts to existing bar wall
- Ideal for retrofit when bar wall is already built
- Cleanability
- aesthetics / modern look



## STAINLESS STEEL DRAINBOARD FILLERS

Bolt On To Sides Of Equipment  
Multiple Angles Available • Optional Legs  
(See Page 113)

Contact SmartFab Department For Details & Pricing

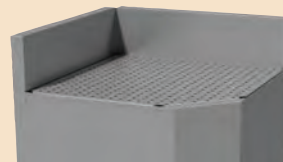

## BAR DIE SYSTEM ACCESSORIES & MODIFICATIONS

Factory Installed Only - Except SU-BDB-100 (Supplied Loose For In Field Positioning)



Recessed GFI  
Duplex Outlet

SU-62C \$719



Cool White LED Light 1.5 Watt

- Single Box w/ Cover Plate
- Power Supply & Wiring Not Included

SU-BDL-CW \$315 ea.



Receptacle Box  
Only

SU-62F \$95



LED Light Power Supply

- 100 Watts
- Handles Up to 35 Lights

SU-BDT-100 \$356 ea.

## Floor Templates Available

SU-82 Call For Price



Templates Are Printed On Paper Rolls  
& Are Marked For Easy Alignment



## Underbar Hand Sinks

### All Prestige Hand Sinks Feature:

- Deep Drawn Seamless Sink Bowl
- 1 1/2" IPS, 3 1/2" Basket Drain
- 7" Backsplash
- Stainless Steel Legs w/ Stainless Steel Adjustable Bullet Feet
- Adjustable Stainless Steel Side Cross-Bracing (Except PRHSC series)

29" Working Height

All Faucets Included Meet Federal Lead Free Standards

## STANDARD BAR HAND SINKS

- **PRHS-19 Series** Includes  
4" O.C. Splash Mt. Swing Spout Faucet
- **PRHS-24 Series** Includes  
4" O.C. Deck Mt. Swing Spout Faucet  
& Has Rear Deck For Extra Storage

L	w/ SPLASH MOUNT FAUCET				w/ DECK MOUNT FAUCET			
	20" WIDE	Price	Wt.	Cu.	25" WIDE	Price	Wt.	Cu.
12"	PRHS-19-12	\$1902	35 lbs.	8	PRHS-24-12	\$1985	28 lbs.	8
18"	PRHS-19-18	1929	40 lbs.	9	PRHS-24-18	2011	30 lbs.	9



PRHS-19-12 Shown

## HAND SINKS WITH SOAP & TOWEL DISPENSER

- Deck Mount Soap Dispenser
- C-Fold Towel Dispenser
- **PRHSST-19 Series** Includes  
4" O.C. Splash Mt. Swing Spout Faucet
- **PRHSST-24 Series** Includes  
K-124 Deck Mt. Faucet & Has  
Rear Deck For Extra Storage

L	w/ SPLASH MOUNT FAUCET				w/ DECK MOUNT FAUCET			
	20" WIDE	Price	Wt.	Cu.	25" WIDE	Price	Wt.	Cu.
12"	PRHSST-19-12	\$2611	53 lbs.	8	PRHSST-24-12	\$2382	58 lbs.	8
18"	PRHSST-19-18	2635	55 lbs.	9	PRHSST-24-18	2407	60 lbs.	9



PRHSST-24-12 Shown

## HAND SINK ACCESSORIES & MODIFICATIONS



**Add Wrist Handles**  
Available For Splash or Deck Mount Faucets

**K-316-LU \$175**



**Chrome Towel Ring**  
Packed Loose

**A-15 \$143**



**Replacement Soap Deck Mount Dispenser**

**K-12 \$222**

<b>K-123</b>	Replacement Splash Mt. Faucet	<b>\$518</b>
<b>K-124</b>	Replacement Deck Mt. Faucet	<b>503</b>
<b>SU-73</b>	Add Mirror Finish <i>Factory Install Only</i>	<b>611</b>
<b>SU-74</b>	All Stainless Steel Construction Upgrade	<b>727</b>
<b>SU-75</b>	Add Welded Stainless Steel Cross-Bracing	<b>174</b>
<b>SU-20R or L</b>	Right or Left Side Splash for 20" Wide Unit	<b>268</b>
<b>SU-20RL</b>	Right & Left Side Splash for 20" Wide Unit	<b>530</b>
<b>SU-25R or L</b>	Right or Left Side Splash for 25" Wide Unit	<b>319</b>
<b>SU-25RL</b>	Right & Left Side Splash for 25" Wide Unit	<b>712</b>

For Our Full Line Of Accessories & Modifications, See Pages 118-120.



Featuring **Deep Drawn Seamless Sink Bowls**

29" Working Height

All Faucets Included Meet Federal Lead Free Standards

**NSF** All Sinks Are NSF Approved

**PRESTIGE**  
*Signature Series*

# Underbar Hand Sinks & Glass Rinse Sinks

## HAND SINK WITH DRAINBOARD

- One Piece Deep Drawn 14" X 10" X 7" Sink Bowl With 2" Drain And Strainer Plate
- K-125 Splash Mount Swing Spout Faucet
- Sturdy Stainless Steel Base Cabinet
- Removable Perforated Drainboard Top
- Stainless Steel Legs With Adjustable Stainless Steel Bullet Feet
- 7" Backsplash

L	25" WIDE	Price	Wt.	Cu. Ft.
24"	PRCS-25-24	\$4300	74 lbs.	19

Features  
Removable Perforated  
Drainboard Top

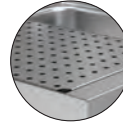

## HAND SINK WITH GLASS RINSER

- One Piece Deep Drawn 9" x 9" x 4" Sink Bowl With 2" Drain And Strainer Plate
- K-125 Splash Mount Swing Spout Faucet
- 29" Working Height
- 7" Backsplash
- Stainless Steel Top, Apron, Sides, Legs And Adjustable Bullet Feet
- Stainless Steel Glass Rinsers With Removable Drainboard
- Adjustable Stainless Steel Side Cross-Bracing

L	25" WIDE	Price	Wt.	Cu. Ft.
18"	PRCS-25-12	\$3134	65 lbs.	7

Features  
Removable Perforated  
Drainboard Top

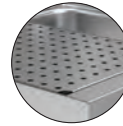

## HAND SINK WITH GLASS RINSER & DIPPER WELL

- One Piece Deep Drawn 14" x 10" x 7" Sink Bowl With 2" Drain And Strainer Plate
- K-125 Splash Mount Swing Spout Faucet
- 29" Working Height
- 7" Backsplash
- Stainless Steel Top, Apron, Sides, Legs And Adjustable Bullet Feet
- Dipper Well With A-33 Faucet
- Stainless Steel Glass Rinsers With Removable Drainboard
- Adjustable Stainless Steel Side Cross-Bracing

L	25" WIDE	Price	Wt.	Cu. Ft.
18"	PRCS-25-18	\$4200	80 lbs.	9

Features  
Removable Perforated  
Drainboard Top

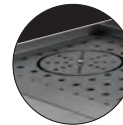

## HAND SINK WITH GLASS RINSER, DIPPER WELL & CUTTING BOARD

- One Piece Deep Drawn 9" x 9" x 4" Sink Bowl With 2" Drain And Strainer Plate
- K-125 Splash Mount Swing Spout Faucet
- 29" Working Height
- 7" Backsplash
- Stainless Steel Top, Apron, Sides, Legs And Adjustable Bullet Feet
- Dipper Well With A-33 Faucet
- Stainless Steel Glass Rinsers With Removable Drainboard
- Adjustable Stainless Steel Side Cross-Bracing
- Removable 10" x 12" Poly Cutting Board

L	25" WIDE	Price	Wt.	Cu. Ft.
24"	PRSP-25-24	\$4600	80 lbs.	11

Features  
Removable Perforated  
Drainboard Top

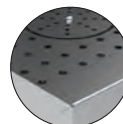

## Hand Sink Cabinets

### HAND SINKS WITH CABINET BASE

- All Stainless Steel Cabinet Base
- Hinged Cabinet Door
- **PRHSC-19 Series** Includes  
4" O.C. Splash Mt. Swing Spout Faucet
- **PRHSC-24 Series** Includes  
K-124 Deck Mt. Faucet & Has  
Rear Deck For Extra Storage



PRHSC-19-12 Shown

L	w/ SPLASH MOUNT FAUCET			w/ DECK MOUNT FAUCET		
	20" WIDE	Price	Wt. Cu.	25" WIDE	Price	Wt. Cu.
12"	PRHSC-19-12	\$2986	78 lbs. 9	PRHSC-24-12	\$3083	83 lbs. 10
18"	PRHSC-19-18	3343	80 lbs. 9	PRHSC-24-18	3415	85 lbs. 10

### HAND SINK WITH BUILT-IN DUMP SINK & WASTE CHUTE **NSF**

- 9" x 9" x 4" Dump Sink
- 5-1/2" Diameter Waste Chute
- Optional Removable Hinged Doors (Add SU-27 For Door lock)
- 7" Backsplash
- Stainless Steel Legs w/ Adjustable Stainless Steel Bullet Feet
- **PRWC-19 Series** Includes 4" O.C. Splash Mt. Swing Spout Faucet
- **PRWC-24 Series** Includes 4" O.C. Deck Mt. Swing Spout Faucet  
& Has Rear Deck For Extra Storage



PRWC-19-18-DR Shown

L	Style	w/ SPLASH MT. FAUCET		w/ DECK MT. FAUCET		Approx. Wt.	Approx. Cu. Ft.
		25" WIDE	Price	30" WIDE	Price		
18"	w/ Hinged Door	PRWC-19-18-DR	3843	PRWC-24-18-DR	3908	67 lbs.	15

### HAND SINK ACCESSORIES & MODIFICATIONS



**Add Wrist Handles**  
Available For Splash or  
Deck Mount Faucets  
**K-316-LU \$175**



**Chrome Towel Ring**  
Packed Loose  
**A-15 \$143**



**Replacement Soap Deck Mount Dispenser**  
**K-12 \$222**

<b>K-123</b>	Replacement Splash Mt. Faucet	<b>\$518</b>
<b>K-124</b>	Replacement Deck Mt. Faucet	<b>503</b>
<b>SU-73</b>	Add Mirror Finish <i>Factory Install Only</i>	<b>611</b>
<b>SU-74</b>	All Stainless Steel Construction Upgrade	<b>727</b>
<b>SU-75</b>	Add Welded Stainless Steel Cross-Bracing	<b>174</b>
<b>SU-20R or L</b>	Right or Left Side Splash for 20" Wide Unit	<b>268</b>
<b>SU-20RL</b>	Right & Left Side Splash for 20" Wide Unit	<b>530</b>
<b>SU-25R or L</b>	Right or Left Side Splash for 25" Wide Unit	<b>319</b>
<b>SU-25RL</b>	Right & Left Side Splash for 25" Wide Unit	<b>712</b>

For Our Full Line Of Accessories & Modifications, See Pages 118-120.

**Featuring Deep Drawn Seamless Sink Bowls**



All Faucets Included Meet Federal Lead Free Standards

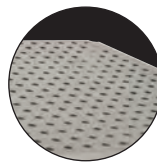

Featuring Perforated Drainboard

**PRESTIGE**  
*Signature Series*  
**Underbar Sinks**

**NSF** All Sinks Are NSF Approved

**BAR SINKS**

Featuring 10" x 14" x 10" Deep Drawn Seamless Bowls & 29" Working Height

- 7" High Backsplash
- Removable Perforated Drainboard Top
- 9" Overflow Pipe w/ 1 1/2" IPS Drain Included Per Sink Bowl
- Sound Deadened
- Stainless Steel Top, Apron, Sides
- Stainless Steel Legs w/ Adjustable Stainless Steel Bullet Feet
- Adjustable Stainless Steel Side Cross-Bracing
- **PRB-19 Series** Includes 1 - 4" O.C. Splash Mounted Swing Spout Faucet
- **PRB-24 Series** Includes 1 - 4" O.C. Deck Mounted Swing Spout Faucet & Has Rear Deck For Extra Storage



**PRB-19 Series with Drainboards Shown**  
20" Wide Units Include Splash Mount Faucet(s)



**PRB-24 Series**  
25" Wide Units With Deck Mount Faucets

L And R Indicate Sink Location. C Indicates Sink Is Centered.

	w/ SPLASH MOUNT FAUCET			w/ DECK MOUNT FAUCET			O.A. Length	# of Drbds.	Drbd. Length	Approx. Weight	Approx. Cu. Ft.
	20" WIDE	Price	Spout Length	25" WIDE	Price	Spout Length					
<b>1 COMP.</b>	PRB-19-31C	\$2570	6"	PRB-24-31C	\$2714	6"	36"	2	12"	89 lbs.	12
<b>2 COMP.</b>	PRB-19-22C	2580	6"	PRB-24-22C	2654	6"	24"	N/A	N/A	89 lbs.	8
	PRB-19-32LorR	2773	6"	PRB-24-32LorR	2888	6"	36"	1	11"	89 lbs.	12
	PRB-19-42LorR	2913	6"	PRB-24-42LorR	3069	6"	48"	1	23"	105 lbs.	16
	PRB-19-42C	2913	6"	PRB-24-42C	3069	6"	48"	2	12"	105 lbs.	16
<b>3 COMP.</b>	PRB-19-33C	2995	10"	PRB-24-33C	3093	12"	36"	N/A	N/A	105 lbs.	12
	PRB-19-43LorR	3406	10"	PRB-24-43LorR	3561	12"	48"	1	11"	107 lbs.	16
	PRB-19-53LorR	3718	10"	PRB-24-53LorR	3936	12"	60"	1	23"	125 lbs.	20
	PRB-19-53C	3812	10"	PRB-24-53C	4033	12"	60"	2	12"	125 lbs.	20
	PRB-19-63C	4009	10"	PRB-24-63C	4119	12"	72"	2	18"	143 lbs.	24
	PRB-19-73C	4167	10"	PRB-24-73C	4330	12"	84"	2	24"	190 lbs.	42
<b>4 COMP.</b>	PRB-19-83C	4961	10"	PRB-24-83C	5200	12"	96"	2	30"	176 lbs.	48
	PRB-19-44C*	3738	6"	PRB-24-44C*	3866	6"	48"	N/A	N/A	107 lbs.	16
	PRB-19-64C*	4562	6"	PRB-24-64C*	4722	6"	72"	2	12"	147 lbs.	24
	PRB-19-74C*	4733	6"	PRB-24-74C*	4922	6"	84"	2	18"	163 lbs.	42
	PRB-19-84C*	5583	6"	PRB-24-84C*	5823	6"	96"	2	24"	178 lbs.	48

\*4 Comp. Bar Sinks Include 2 - 6" Swing Spout Faucets

**BAR SINK ACCESSORIES & MODIFICATIONS**

SU-73 Add Mirror Finish (Factory Install Only)	<b>\$611</b>	SU-20R or L Right Or Left Side Splash For PRB-19 Series	<b>\$268</b>
SU-74 All Stainless Steel Construction Upgrade	<b>727</b>	SU-20RL Right & Left Side Splash For PRB-19 Series	<b>530</b>
SU-75 Add Welded Stainless Steel Cross-Bracing	<b>174</b>	SU-25R or L Right Or Left Side Splash For PRB-24 Series	<b>319</b>
SU-79 Additional Drainboard Length	<b>205 LinFt.</b>	SU-25RL Right & Left Side Splash For PRB-24 Series	<b>712</b>

# PRESTIGE

Signature Series

## Ice Bins

**PRI & PRC Series Feature:**

- Includes Two Removable Plastic Bottle Racks
- 1 3/4" Return w/ Soda Gun Knock Out (Cold Plate Models Only)
- 7" Backsplash

- Stainless Steel Top, Apron & Sides
- Stainless Steel Legs w/ Adjustable Stainless Steel Bullet Feet
- Adjustable Stainless Steel Side Cross-Bracing
- 1" IPS Drain (Non-Cold Plate Bin); 1/2" IPS Drain (Cold Plate Bin)
- **OPTIONAL** 10-Circuit Cold Plate Sealed Into The Bottom

All Bottle Racks Must Be Removed For NSF Compliance & For Use With Optional Cover

Quick Pour Bottles Not Included

**NSF** All Ice Bins Are NSF Approved

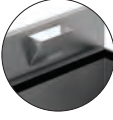

Soda Chase Provision (Tip-out)  
**SU-30 \$736**  
Only For Ice Bins w/ Backsplash



PRC-19-48LR



PRI-19-24-10

## ICE BINS

29" Working Height

- PRI-24 Series Has Rear Deck For Extra Storage

Ice Bin Depth	Overall Length	Ice Bin Capacity	20" WIDE	Price	25" WIDE	Price	Approx. Weight	Approx. Cu. Ft.
11" DEEP	12"	55 lbs.	PRI-19-12	\$1625	PRI-24-12	\$1683	60 lbs.	11
	18"	60 lbs.	PRI-19-18	1937	PRI-24-18	1997	65 lbs.	
	24"	65 lbs.	PRI-19-24	2069	PRI-24-24	2128	70 lbs.	11
	30"	70 lbs.	PRI-19-30	2283	PRI-24-30	2411	75 lbs.	15
	36"	75 lbs.	PRI-19-36	2421	PRI-24-36	2615	80 lbs.	15
	42"	80 lbs.	PRI-19-42	3312	PRI-24-42	3590	85 lbs.	20
15" DEEP	48"	85 lbs.	PRI-19-48	3469	PRI-24-48	3886	90 lbs.	20
	24"	80 lbs.	PRI-19-24-XD	3172	PRI-24-24-XD	3281	85 lbs.	20
	30"	85 lbs.	PRI-19-30-XD	3109	PRI-24-30-XD	3494	90 lbs.	27
	36"	90 lbs.	PRI-19-36-XD	2765	PRI-24-36-XD	3751	95 lbs.	37
<b>w/ 10-CIRCUIT COLD PLATE</b>								
11" DEEP	24"	135 lbs.	PRI-19-24-10	4531	PRI-24-24-10	4752	140 lbs.	18
	30"	140 lbs.	PRI-19-30-10	5425	PRI-24-30-10	5607	145 lbs.	24
	36"	145 lbs.	PRI-19-36-10	5607	PRI-24-36-10	5891	150 lbs.	24
	42"	150 lbs.	PRI-19-42-10	5678	PRI-24-42-10	6096	155 lbs.	31
	48"	155 lbs.	PRI-19-48-10	6440	PRI-24-48-10	6860	160 lbs.	31
15" DEEP	24"	160 lbs.	PRI-19-24-10-XD	5458	PRI-24-24-10-XD	5687	165 lbs.	20
	30"	165 lbs.	PRI-19-30-10-XD	6290	PRI-24-30-10-XD	6452	175 lbs.	27
	36"	170 lbs.	PRI-19-36-10-XD	6581	PRI-24-36-10-XD	7823	175 lbs.	27

## ICE BIN & BOTTLE STORAGE COMBO

11" Deep Insulated Ice Bin • 29" Working Height

- Welded Partition Between Bins
- PRC-24 Series Has Rear Deck For Extra Storage

L And R Indicate Ice Bin Location On Either Right Or Left Side. LR Indicates Ice Bin Is Centered.

Overall Length	# Of Independent Bins	Ice Bin Capacity	20" WIDE	Price	25" WIDE	Price	Approx. Weight	Approx. Cu. Ft.
36"	2	70/32 lbs.	PRC-19-36L or R	\$3350	PRC-24-36L or R	\$3474	105 lbs.	15
42"	2	89/32 lbs.	PRC-19-42L or R	3587	PRC-24-42L or R	3742	110 lbs.	20
48"	2	108/32 lbs.	PRC-19-48L or R	3834	PRC-24-48L or R	4017	120 lbs.	20
48"	3	32/70/32 lbs.	PRC-19-48LR	4707	PRC-24-48LR	4907	160 lbs.	22
54"	3	32/89/32 lbs.	PRC-19-54LR	4880	PRC-24-54LR	5081	165 lbs.	27
60"	3	32/108/32 lbs.	PRC-19-60LR	5077	PRC-24-60LR	5286	170 lbs.	27
<b>w/ 10-CIRCUIT COLD PLATE</b>								
36"	2	70/32 lbs.	PRC-19-36L-10 or R-10	5887	PRC-24-36L-10 or R-10	6020	165 lbs.	24
42"	2	89/32 lbs.	PRC-19-42L-10 or R-10	6316	PRC-24-42L-10 or R-10	6284	175 lbs.	31
48"	2	108/32 lbs.	PRC-19-48L-10 or R-10	6371	PRC-24-48L-10 or R-10	6552	185 lbs.	33
48"	3	32/70/32 lbs.	PRC-19-48LR-10	7252	PRC-24-48LR-10	7448	195 lbs.	33
54"	3	32/89/32 lbs.	PRC-19-54LR-10	7424	PRC-24-54LR-10	7624	200 lbs.	40
60"	3	32/108/32 lbs.	PRC-19-60LR-10	7614	PRC-24-60LR-10	7831	205 lbs.	40

\*Reverse Ice Bin Capacities For L or R Models.

For Prestige Ice Bin Covers, See Page 119.

## Underbar Corner Drainboard & Fillers

### 90° CORNER DRAINBOARD

Includes Stainless Steel Legs w/ Adjustable Stainless Steel Bullet Feet

- Free-Standing Corner Drainboard
- 7" High x 1-3/4" Thick Backsplash
- 1" I.P.S. Drain

Model #	Price	Size* (A) x (B)	Approx. Weight	Approx. Cu. Ft.
PRFD-2020	<b>\$1473</b>	20" x 20"	68 lbs.	7
PRFD-2025	<b>1556</b>	20" x 25"	72 lbs.	12
PRFD-2030	<b>1616</b>	20" x 30"	78 lbs.	16
PRFD-2035	<b>1748</b>	20" x 35"	82 lbs.	16
PRFD-2520	<b>1556</b>	25" x 20"	69 lbs.	7
PRFD-2525	<b>1632</b>	25" x 25"	73 lbs.	12
PRFD-2530	<b>1673</b>	25" x 30"	79 lbs.	16
PRFD-2535	<b>1834</b>	25" x 35"	83 lbs.	16
PRFD-3020	<b>1616</b>	30" x 20"	78 lbs.	7
PRFD-3025	<b>1673</b>	30" x 25"	79 lbs.	12
PRFD-3030	<b>1884</b>	30" x 30"	82 lbs.	16
PRFD-3035	<b>1974</b>	30" x 35"	86 lbs.	16
PRFD-3520	<b>1748</b>	35" x 20"	82 lbs.	16
PRFD-3525	<b>1834</b>	35" x 25"	83 lbs.	16
PRFD-3530	<b>1974</b>	35" x 30"	86 lbs.	16
PRFD-3535	<b>2083</b>	35" x 35"	90 lbs.	16

All Units On This Page Feature A Removable Perforated Drainboard Top

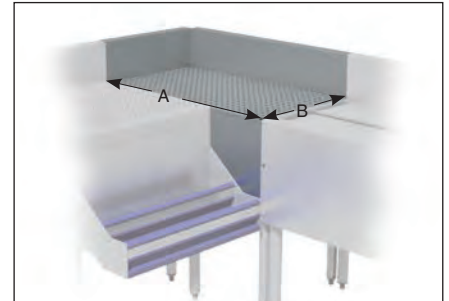
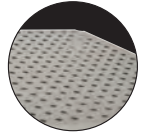

PRFD-3020

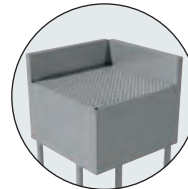

Includes Stainless Steel Legs w/ Adjustable Stainless Steel Bullet Feet

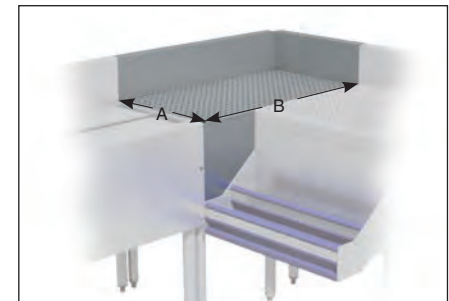

PRFD-2030

"A" represents the distance on the left side from the back wall until the front edge of the left unit.  
 "B" represents the distance on the right side from the back wall until the front edge of the right unit.

### 90° CORNER FILLERS

- Must Be Bolted to Existing Line Up Equipment
- 7" High x 1-3/4" Thick Backsplash
- Available On Left or Right Side
- 1" I.P.S. Drain

#### Inside Corner



PRF-20-90IC Shown

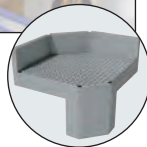

#### Outside Corner

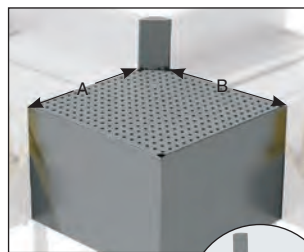

PRF-20-90OC Shown



Model #	Price	Size (A) x (B)	Approx. Weight	Approx. Cu. Ft.
PRF-20-90IC or OC*	<b>\$1573</b>	20" x 20"	82 lbs.	16
PRF-25-90IC or OC*	<b>1632</b>	25" x 25"	84 lbs.	16

\* IC = Inside Corner OC = Outside Corner

### 45° CORNER FILLERS

- Must Be Bolted to Existing Line Up Equipment
- 7" High x 1-3/4" Thick Backsplash
- 1" I.P.S. Drain

#### Inside Corner

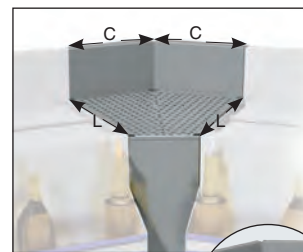

PRF-20-45IC Shown



#### Outside Corner

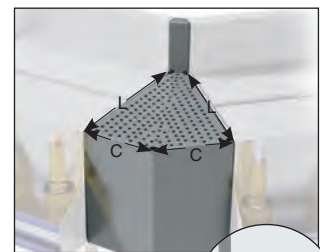

PRF-20-45OC Shown

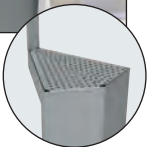

	Model #	Price	Size L x W x H	C	Approx. Weight	Approx. Cu. Ft.
INSIDE CORNER	PRF-20-45IC	<b>\$1205</b>	20" x 20 3/8" x 21 5/8"	11 7/8"	82 lbs.	16
INSIDE CORNER	PRF-25-45IC	<b>1330</b>	25" x 27 1/8" x 21 5/8"	14"	84 lbs.	16
OUTSIDE CORNER	PRF-20-45OC	<b>1205</b>	20" x 16 3/8" x 21 5/8"	8 7/8"	82 lbs.	16
OUTSIDE CORNER	PRF-25-45OC	<b>1330</b>	25" x 20 1/4" x 21 5/8"	11"	84 lbs.	16

**PLEASE NOTE: FILLERS BUILT TO ORDER & CAN NOT BE RETURNED**

**OPTIONAL LEGS & CUSTOM SIZES AVAILABLE**  
 Consult Factory For Details

# PRESTIGE Signature Series



All Drainboards Are NSF Approved

## Underbar Drainboards

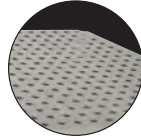

Removable Perforated Drainboard Top

### PRD & PRGS Series Feature:

- Removable Perforated Drainboard Top
- Stainless Steel Top, Sides & Legs w/ Adjustable Stainless Steel Bullet Feet
- Adjustable Stainless Steel Side Cross-Bracing
- 7" Backsplash
- 1" IPS Drain
- Sound Deadened

### 29" Working Height

- Stainless Steel Apron
- PRD-24 Series has Rear Deck For Extra Storage

L	20" WIDE	Price	Approx. Weight	Approx. Cu. Ft.	25" WIDE	Price	Approx. Weight	Approx. Cu. Ft.
12"	PRD-19-12	\$1365	38 lbs.	8	PRD-24-12	\$1463	45 lbs.	10
18"	PRD-19-18	1401	45 lbs.	8	PRD-24-18	1532	52 lbs.	10
24"	PRD-19-24	1516	52 lbs.	8	PRD-24-24	1663	59 lbs.	10
30"	PRD-19-30	1671	59 lbs.	12	PRD-24-30	1772	66 lbs.	14
36"	PRD-19-36	1733	65 lbs.	12	PRD-24-36	1902	73 lbs.	14
42"	PRD-19-42	2022	70 lbs.	16	PRD-24-42	2228	79 lbs.	19
48"	PRD-19-48	2174	75 lbs.	16	PRD-24-48	2267	86 lbs.	19



PRD-19 Series  
20" Wide Units



PRD-24 Series  
25" Wide Units

## RECESSED DRAINBOARDS

Holds Multiple Tiers Of Glassware • 18" Working Height

- 14" Side Splashes
- PRGS-24 Series has Rear Deck For Extra Storage

L	25" WIDE	Price	Approx. Weight	Approx. Cu. Ft.	30" WIDE	Price	Approx. Weight	Approx. Cu. Ft.
12"	PRGS-19-12	\$1516	40 lbs.	8	PRGS-24-12	\$1659	45 lbs.	10
18"	PRGS-19-18	1566	45 lbs.	8	PRGS-24-18	1662	52 lbs.	10
24"	PRGS-19-24	1653	52 lbs.	8	PRGS-24-24	1739	59 lbs.	10
30"	PRGS-19-30	1773	59 lbs.	12	PRGS-24-30	1903	66 lbs.	14

Removable Perforated Drainboard Top

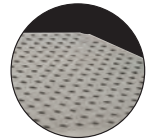

PRGS-19 Series  
25" Wide Units



PRGS-24 Series  
30" Wide Units

**WANT TO UPGRADE?** Add SU-74 For All Stainless Steel Construction \$516

### GLASS RINER FOR PERFORATED DRAINBOARDS (Activator Only) **FACTORY INSTALLED ONLY**

SU-16P	\$1043	4 1/4" Diameter	3 lbs.	1
--------	--------	-----------------	--------	---



SU-16P

## FROZEN DRINK MACHINE STANDS

21" Working Height



PRFD-18

- Lower Working Height Accommodates The Height Of Most Drink Machines For Underbar Use
- Beveled Front
- Top Pitched To 1" IPS Drain
- Stainless Steel Top, Apron, Sides & Legs w/ Adjustable Stainless Steel Bullet Feet
- Adjustable Stainless Steel Side Cross-Bracing
- 15" Backsplash

L	30" WIDE	Price	Wt.	Cu. Ft.
18"	PRFD-18	\$2300	57 lbs.	14
30"	PRFD-30	2543	80 lbs.	20

# PRESTIGE Signature Series Drainboard Cabinets



**Open Base**  
PRSCO-19-24 Shown



**w/ Hinged Doors**  
PRSCD-24-24 Shown



All Stainless Steel Construction

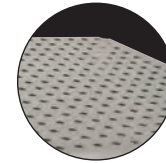

Features  
Removable Perforated  
Drainboard Top

- Sturdy Base Cabinet
- Removable Perforated Drainboard Top
- Removable Hinged Doors
- 7" Backsplash
- Stainless Steel Legs w/ Adjustable Stainless Steel Bullet Feet
- 1" IPS Drain
- Sound Deadened

	L	25" WIDE	Price	Approx. Weight	Approx. Cu. Ft.	30" WIDE	Price	Approx. Weight	Approx. Cu. Ft.
OPEN BASE	12"	PRSCO-19-12	\$1880	48 lbs.	12	PRSCO-24-12	\$2058	55 lbs.	15
	18"	PRSCO-19-18	2052	55 lbs.	12	PRSCO-24-18	2230	62 lbs.	15
	24"	PRSCO-19-24	2284	62 lbs.	12	PRSCO-24-24	2448	69 lbs.	15
	30"	PRSCO-19-30	2713	69 lbs.	15	PRSCO-24-30	2877	76 lbs.	18
	36"	PRSCO-19-36	3128	75 lbs.	18	PRSCO-24-36	3296	82 lbs.	22
	42"	PRSCO-19-42	3525	80 lbs.	21	PRSCO-24-42	3691	90 lbs.	28
	48"	PRSCO-19-48	3954	85 lbs.	24	PRSCO-24-48	4120	92 lbs.	30
W/ HINGED DOORS	12"	PRSCD-19-12	2266	58 lbs.	12	PRSCD-24-12	2450	65 lbs.	15
	18"	PRSCD-19-18	2439	65 lbs.	12	PRSCD-24-18	2622	72 lbs.	15
	24"	PRSCD-19-24	2718	72 lbs.	12	PRSCD-24-24	2886	79 lbs.	15
	30"	PRSCD-19-30	3150	79 lbs.	15	PRSCD-24-30	3316	85 lbs.	18
	36"	PRSCD-19-36	3568	85 lbs.	18	PRSCD-24-36	3733	92 lbs.	22
	42"	PRSCD-19-42	3965	90 lbs.	21	PRSCD-24-42	4303	98 lbs.	28
	48"	PRSCD-19-48	4398	95 lbs.	24	PRSCD-24-48	4558	102 lbs.	30

## PRSCO & PRSCD Series Modifications And Accessories

### ADD MID-SHELF TO PRSCO SERIES \$630/shelf

Add An "-M" After The Model Number  
(For example, PRSCO-19-18 would read PRSCO-19-18-M)

### ADD A SINK (Includes Faucet)

10" x 14" x 10" SU-22A \$1382  
9" x 9" x 4" SU-22C \$1382

6" Stainless Steel  
Open Waste Chute  
Fits 6" Dia. Cutout

A-6  
\$191



Factory Installed

6" Dipper Well with  
Insert and Drain  
Fits 6" Dia. Cutout

A-7  
\$500



Factory Installed. Includes TA-34 Cutout.

**20" WIDE CABINETS AVAILABLE!**  
Use 25" Wide Model # & Add SU-77 \$125

**LOCK IT UP!**  
Add A Door Lock SU-27 \$474

# PRESTIGE

*Signature Series*

## Trash Receptacles

### TRASH RECEPTACLE CABINET WITH CHUTE

**Trash Bin Not Included**

- Open Bottom w/ Hinged Door
- Accommodates Slim Jim® Trash Can Measuring 11" x 20" x 25" (15 7/8 Gal. Cap.)
- S/S Legs w/ Adj. Stainless Steel Bullet Feet
- Overall Size: 12" x 25" x 33-3/4"
- 60 lbs. 9 Cu. Ft.

**PRSJT-12-DR \$2700**

PRSJT-DR



Shown With Slim Jim® Trash Can (Not Included)

### TRASH RECEPTACLE COVER WITH CHUTE

**Trash Bin Not Included**

- Accommodates Slim Jim® Trash Can Measuring 11" x 20" x 25" (15 7/8 Gallon Capacity)
- Units Mount Between Equipment Line Up
- Overall Size: 12" x 25" x 9-3/4"
- 33 lbs. 4 Cu. Ft.

**PRSJT-12 \$1044**



Shown With Slim Jim® Trash Can (Not Included)



### TRASH RECEPTACLE COVER WITH DOOR

**Trash Bin Not Included**

- Open Bottom w/ Hinged Door
- Accommodates Slim Jim® Trash Can Measuring 11" x 20" x 25" (15 7/8 Gallon Capacity)
- Units Mount Between Equipment Line Up
- Removable S/S Sliding Cover
- Overall Size: 12" x 25" x 21-5/8"
- 35 lbs. 4 Cu. Ft.

**PRT-12 \$1896**



Shown With Slim Jim® Trash Can (Not Included)

### POINT OF SERVICE CABINET



**PRPOS-18-DR**  
Shown with  
Optional  
Door Lock



- 25" Working Height
- 11" High Backsplash & Side Splashes
- Louvered Door w/ Flush Handle
- 2" Access Hole In Work Surface For Power Cord
- Stainless Steel Top, Apron, Sides & Legs
- With Adjustable Stainless Steel Bullet Feet

### Optional Legs Support

Model	Location	Price
SU-48L	Left	\$428
SU-48R	Right	\$428

(One Set Includes Two Legs with Cross-Brace)

For Models  
PRSJT-12  
& PRT-12



L	25" WIDE	Price	Wt.	Cu. Ft.
18"	PRPOS-18-DR	\$3049	60 lbs.	14
24"	PRPOS-24-DR	\$3408	150 lbs.	20

**LOCK IT UP!**  
Add A Door Lock SU-27 \$474

## Underbar Speed Bars & Bins

### PASS-THRU ICE BINS

11" Deep Insulated Ice Bin • 29" Working Height

- Stainless Steel Top, Apron, Sides & Legs w/ Adjustable Stainless Steel Bullet Feet
- Adjustable Stainless Steel Side Cross-Bracing
- **PRPT-2442-10** Has 10-Circuit Cold Plate Sealed Into The Bottom

For Sliding Stainless Steel Covers, See Page 119



Shown With Optional Speed Rail

Model #	Price	Size W x L x H	Ice Capacity	Wt.	Cu. Ft.
PRPT-2442	<b>\$3452</b>	42" x 24" x 29"	174 lbs.	80 lbs.	13
PRPT-2442-10	<b>6002</b>	42" x 24" x 29"	174 lbs.	150 lbs.	13



### BEER BOX

18" Deep • 29" Working Height

- Perforated False Bottom Allows Melted Ice To Drain
- Removable False Bottom
- Stainless Steel Legs w/ Stainless Steel Bullet Feet
- 7" Backsplash



Model #	Price	Size W x L x H	Capacity Of Bottle Beer	Wt.	Cu. Ft.
PRBB-36	<b>\$4200</b>	25" x 36" x 33"	6 Cases	215 lbs.	14
PRBB-48	<b>4246</b>	25" x 48" x 33"	12 Cases	220 lbs.	14
PRBB-60	<b>4552</b>	25" x 60" x 33"	18 Cases	225 lbs.	15



PRBB-48

#### BEER BOX LOCKING COVERS

Includes Padlock & 2 Keys

SU-35C	48" Cover	<b>\$1130</b>
SU-35D	60" Cover	<b>1399</b>

Add Stainless Steel Dividers

SU-55 **\$252 ea.**

*Beer Box Covers Must Be Removed During Normal Operation*

### UNI-SERV SPEED BAR

Includes 30" Speed Rail • 7" Backsplash



PRU-24-60R Shown



15A - 120V GFI Duplex Receptacle Hidden Beneath Blender Shelf



- **48" Units:** 9" x 9" x 4" Deep Drawn Sink Bowl
- **60" Units:** 10" x 14" x 7" Deep Drawn Sink Bowl
- Recessed 18" Blender Station
- 3 1/2" Basket Drain
- Grommet Hole For Cord
- 30" x 11" Deep Insulated Ice Bin with Two Removable Plastic Bottle Racks
- Optional 10-Circuit Cold Plate Sealed Into The Bottom Of Ice Bin
- 1" I.P.S. Drain (1/2" I.P.S. Drain For Cold Plate Models)
- 7" Backsplash with 1 3/4" Return With

- Soda Gun Knock Out
- Recessed Drainboard with Removable Perforated Top with 1" I.P.S. Drain
- Stainless Steel Top, Apron, Sides & Legs with Stainless Steel Bullet Feet
- Adjustable Stainless Steel Side Cross-Bracing
- **PRU-19 Series:** 4" O.C. Splash Mounted Swing Spout Faucet
- **PRU-24 Series:** 4" O.C. Deck Mounted Swing Spout Faucet

L	25" WIDE	O.A. Size	Price	30" WIDE	O.A. Size	Price	Approx. Weight	Approx. Cu. Ft.
48"	PRU-19-48LorR	25"x48"	<b>\$5471</b>	PRU-24-48LorR	30"x48"	<b>\$6080</b>	135 lbs.	35
60"	PRU-19-60LorR	25"x60"	<b>6417</b>	PRU-24-60LorR	30"x60"	<b>6497</b>	135 lbs.	35
w/ 10-CIRCUIT COLD PLATE								
48"	PRU-19-48L-10orR-10	25"x48"	<b>7280</b>	PRU-24-48L-10orR-10	30"x48"	<b>7981</b>	170 lbs.	46
60"	PRU-19-60L-10orR-10	25"x60"	<b>8959</b>	PRU-24-60L-10orR-10	30"x60"	<b>9042</b>	170 lbs.	46

*L and R Indicate Ice Bin Location.*

## Pass-Thru Units & Overshelves

### PASS-THRU WORKSTATION

With Two Deep Drawn Sink Bowls • 29" Working Height

- Stainless Steel Top & Sides
- Blender Shelf With Duplex Outlet Hidden Underneath
- Double Tier Speed Rail
- Tubing Chase For Soda Gun
- 15A - 120V GFI Duplex Outlet Hidden Beneath Shelf
- 4" O.C. Deck Mounted Lead Free Compliant Swing Spout Faucet
- Insulated Ice Bin w/ 10-Circuit Cold Plate Sealed Into Bottom
- Stainless Steel Legs w/ Adjustable Stainless Steel Bullet Feet & Welded Cross-Bracing
- **Side Panel Models** Include Removable Perforated Top w/ Drain & Front Apron; Units Are Supported By Side Panels & Do Not Require Legs



GFI Duplex Receptacle Hidden Beneath Blender Shelf



PR-44X42SP-10-L

Model #	Price	O.A. Length	Description	Ice Capacity	Approx. Weight	Approx. Cu. Ft.
PR-42X30-10-L or R	<b>\$8855</b>	42"	Stainless Steel Legs	70 lbs.	250 lbs.	38
PR-42X42-10-L or R	<b>13023</b>	42"	Stainless Steel Legs	174 lbs.	400 lbs.	58
<b>SIDE PANELS WITH PERFORATED DRAINBOARD SHELF</b>						
PR-44X30SP-10-L or R	<b>12095</b>	44"	Side Panels w/ Perforated Drbd. Shelf	70 lbs.	350 lbs.	59
PR-44X42SP-10-L or R	<b>18696</b>	44"	Side Panels w/ Perforated Drbd. Shelf	174 lbs.	575 lbs.	88

#### Dual Soda Gun Holder

- Openings for a single soda gun on each end
- Fits Prestige® Pass-Thru Workstations Only

**SU-43 \$1420**

Factory Installed Only

*NOTE: To determine left or right hand model, Ice Bin is either Left (L) or Right (R) of the sink from the bartender side.*

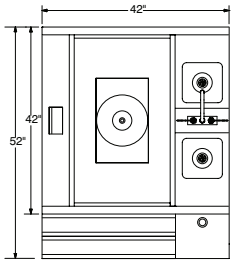

PR-42X42-10-L Shown

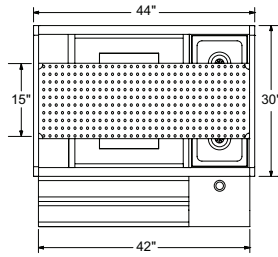

PR-44X30SP-10-L Shown

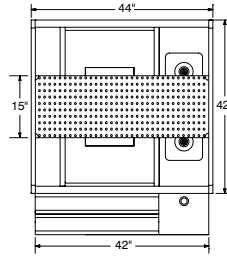

PR-44X42SP-10-L Shown

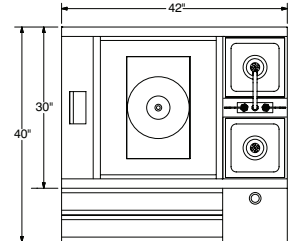

PR-42X30-10-L Shown

## OVERSHELVES FOR PASS-THRU WORKSTATIONS

(For SP Models Only - Factory Installed)

- 44" Wide x 16 3/4" Length
- Removable Perforated Pans
- Square Stainless Steel Posts
- 20 Gauge, 300 Stainless Steel

#### -G Models:

- Include Stemware Glass Rack
- 18 Gauge, 302 Stainless Steel
- Stainless Steel Shelf With Splash On Three Sides

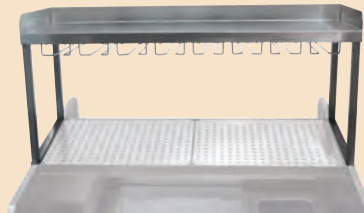

Single Shelf

PRSO-44-G Shown



Double Shelf

PRDO-44 Shown

Model #	Price	Description	Wt.	Cu. Ft.
PRSO-44	<b>\$1756</b>	Single Overshelf	65 lbs.	5
PRSO-44-G	<b>2513</b>	Single Overshelf w/ Stemware Glass Rack	85 lbs.	5
PRDO-44	<b>3051</b>	Double Overshelf	125 lbs.	17
PRDO-44-G	<b>4153</b>	Double Overshelf w/ Stemware Glass Rack	145 lbs.	17

All Blender Stations Are 

# Free Standing Blender Stations

All Blender Stations Include:

- Stainless Steel Top, Apron
- Sides & Legs With Adjustable Stainless Steel Bullet Feet
- Adjustable Stainless Steel Side Cross-bracing



15A - 120V GFI Duplex Receptacle Hidden Beneath Blender Shelf

## BLENDER STATION WITH DEEP DRAWN SINK



**PRRS-19 Series**  
25" Wide Units With  
Splash Mount Faucet



**PRRS-24 Series**  
30" Wide Units With  
Deck Mount Faucet

- Deep Drawn Sink
- Recessed Step w/ Grommet Hole For Blenders
- 7" Backsplash
- 3 1/2" Basket Drain w/ 1 1/2" IPS
- Sound Deadened

- **PRRS-19 Series** Includes 4" O.C. Splash Mounted Swing Spout Faucet
- **PRRS-24 Series** Includes 4" O.C. Deck Mounted Swing Spout Faucet & Has Rear Deck For Extra Storage

Overall Length	w/ SPLASH MT. FAUCET				w/ DECK MT. FAUCET			
	25" WIDE	Price	Approx. Weight	Approx. Cu. Ft.	30" WIDE	Price	Approx. Weight	Approx. Cu. Ft.
12"	PRRS-19-12	\$1809	49 lbs.	9	PRRS-24-12	\$1986	51 lbs.	9
18"	PRRS-19-18	1941	56 lbs.	9	PRRS-24-18	2114	58 lbs.	12

## BLENDER STATION WITH DRAINBOARD



**PRDB-19 Series**  
25" Wide Units



**PRDB-24 Series**  
30" Wide Units

- Removable Perforated Drainboard Top
- Recessed Step w/ Grommet Hole For Blenders
- 7" Backsplash
- 1" IPS Drain

- Sound Deadened
- **PRDB-24 Series** Has Rear Deck For Extra Storage

Overall Length	25" WIDE				30" WIDE			
	Price	Approx. Weight	Approx. Cu. Ft.	Price	Approx. Weight	Approx. Cu. Ft.		
12"	PRDB-19-12	\$1634	45 lbs.	9	PRDB-24-12	\$1766	47 lbs.	9
18"	PRDB-19-18	2271	50 lbs.	9	PRDB-24-18	1997	53 lbs.	12

**NOTE: Blender Stations Can Not Accommodate A Speed Rail**

### BLENDER STATION ACCESSORIES & MODIFICATIONS

SU-73	Add Mirror Finish <i>Factory Install Only</i>	.....	<b>\$611</b>
SU-74	All Stainless Steel Construction Upgrade	.....	<b>727</b>
SU-75	Add Welded Stainless Steel Cross-Bracing	.....	<b>174</b>

6" Stainless Steel Open Waste Chute  
Fits 6" Dia. Cutout

A-6  
**\$191**



Dipper Well Faucet

A-33  
**\$235**



6" Dipper Well with Insert and Drain  
Fits 6" Dia. Cutout

A-7  
**\$500**



Water Filler Faucet

K-54  
8-1/4" High **\$781**  
K-54A  
13" High **\$887**



Add **SU-34** Cutout for A6 or A-7  
**\$142**

## Glassware & Liquor Storage

### GLASS RACK STORAGE CABINETS

Featuring All Stainless Steel Construction



Glass & Liquor Racks Not Included

- Holds Up To 3 Glass Racks
- Adjustable Glass Rack Slides
- 7" Backsplash
- 1" IPS Drain On Bottom Shelf
- Stainless Steel Legs w/ Adjustable Stainless Steel Bullet Feet
- 30" Wide Units Have Rear Deck For Extra Storage



PROR-24-24 Shown



Drainboard Top

Removable Perforated Drainboard Top  
1" IPS Drain

PRCR-19-24 Shown



Slanted Top

- Accommodates Liquor Rack On Slanted Top

PRSR-24-24 Shown

Model #	Price	Size	Wt.	Cu.
PROR-19-24	\$2967	24" x 25" x 36"	50 lbs.	12
PROR-24-24	3100	24" x 30" x 36"	57 lbs.	12

Model #	Price	Size	Wt.	Cu.
PRCR-19-24	\$2286	24" x 25" x 36"	80 lbs.	16
PRCR-24-24	2460	24" x 30" x 36"	85 lbs.	17

Model #	Price	Size	Wt.	Cu.
PRSR-19-24	\$3237	24" x 25" x 36"	50 lbs.	12
PRSR-24-24	3374	24" x 30" x 36"	57 lbs.	12



Add Stainless Steel Full Extension Roller Slides

SU-46 \$1365 /cabinet



Add Stainless Steel Concealing Drawer Front

Requires SU-46

SU-47 \$684 /cabinet

## LIQUOR DISPLAYS

Tiered Steps & Retaining Bars Securely Display Liquor Bottles



PLD-2524



PRLR-24

### Liquor Display Rack

- 5 Steps
- Retaining Bars Secure Bottles On Steps
- Sound Deadened
- 7" Backsplash
- Stainless Steel Top, Sides & Legs w/ Stainless Steel Bullet Feet
- Adjustable Stainless Steel Side Cross-Bracing
- 30" Wide Units Has Rear Deck For Extra Storage

	Model #	Price	Overall Length	Approx. Bottle Capacity	Approx. Weight	Approx. Cu. Ft.
25" DEPTH	PLD-2512	\$2263	12"	15	25 lbs.	10
	PLD-2518	2369	18"	20	30 lbs.	10
	PLD-2524	2699	24"	30	35 lbs.	10
	PLD-2530	2848	30"	35	40 lbs.	14
	PLD-2536	3060	36"	45	50 lbs.	14
30" DEPTH	PLD-3012	2487	12"	15	30 lbs.	12
	PLD-3018	2564	18"	20	35 lbs.	12
	PLD-3024	2713	24"	30	40 lbs.	12
	PLD-3030	2883	30"	35	45 lbs.	17
	PLD-3036	3101	36"	45	55 lbs.	17

### Liquor Display Cabinet

- All Stainless Steel Construction
- 5 steps
- 7" Backsplash
- Stainless Steel Legs w/ Adjustable Stainless Steel Bullet Feet

	Model #	Price	Overall Length	Approx. Bottle Capacity	Approx. Weight	Approx. Cu. Ft.
25" DEPTH	PRLR-12	\$2625	12"	15	35 lbs.	7
	PRLR-18	2734	18"	20	36 lbs.	10
	PRLR-24	2838	24"	30	42 lbs.	13
	PRLR-30	3017	30"	35	47 lbs.	14
	PRLR-36	3261	36"	45	50 lbs.	15

## REMOVABLE STAINLESS STEEL LIQUOR DISPLAY COVERS

Includes Padlock & Two Keys



Display Rack Cover

For PLD Models Only

	Length	Model #	Price
25" WIDE	12"	PRLC-2512	\$982
	18"	PRLC-2518	1066
	24"	PRLC-2524	1151
	30"	PRLC-2530	1238
	36"	PRLC-2536	1323
30" WIDE	12"	PRLC-3012	1086
	18"	PRLC-3018	1358
	24"	PRLC-3024	1425
	30"	PRLC-3030	1476
	36"	PRLC-3036	1527



Display Cabinet Cover

For PRLR Models Only

	Length	Model #	Price
25" WIDE	12"	PRLC-12	\$1187
	18"	PRLC-18	1399
	24"	PRLC-24	1520
	30"	PRLC-30	1581
	36"	PRLC-36	1672

For Prestige Speed Rails, See Pages 117.

COVERS ARE FACTORY INSTALLED ONLY

## ALL STAINLESS STEEL SPEED RAILS NSF

For Prestige Underbar Equipment

- Sound Deadened
- Bolt Holes For Mounting

**Single & Double Tier Options Available**



**Single Tier**  
PRSSR-36 Shown



**Double Tier**  
PRDSR-36 Shown

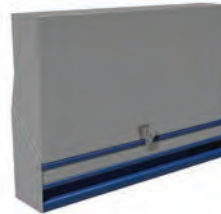

**PRSSR Series**  
w/ Locking Cover



**PRDSR Series**  
w/ Locking Cover

L	STANDARD SPEED RAILS						W/ LOCKING COVER <small>Includes Keyed Lock</small>						Approx. Wt.	Approx. Cu. Ft.
	SINGLE	Price	Cap.	DOUBLE	Price	Cap.	SINGLE	Price	Cap.	DOUBLE	Price	Cap.		
12"	PRSSR-12	\$567	3	PRDSR-12	\$708	6	PRSSR-12-LC	\$920	3	PRDSR-12-LC	\$1158	6	8 lbs.	1
18"	PRSSR-18	583	4	PRDSR-18	803	8	PRSSR-18-LC	1055	4	PRDSR-18-LC	1429	8	10 lbs.	2
24"	PRSSR-24	603	6	PRDSR-24	890	12	PRSSR-24-LC	1129	6	PRDSR-24-LC	1596	12	12 lbs.	2
30"	PRSSR-30	625	7	PRDSR-30	979	14	PRSSR-30-LC	1203	7	PRDSR-30-LC	1772	14	14 lbs.	3
36"	PRSSR-36	646	9	PRDSR-36	1057	18	PRSSR-36-LC	1277	9	PRDSR-36-LC	1929	18	14 lbs.	3
42"	PRSSR-42	662	10	PRDSR-42	1150	20	PRSSR-42-LC	1357	10	PRDSR-42-LC	2108	20	16 lbs.	4
48"	PRSSR-48	679	12	PRDSR-48	1238	24	PRSSR-48-LC	1432	12	PRDSR-48-LC	2282	24	16 lbs.	4
54"	PRSSR-54	705	13	PRDSR-54	1327	26	NOT AVAILABLE						18 lbs.	5
60"	PRSSR-60	725	15	PRDSR-60	1410	30							20 lbs.	5
72"	PRSSR-72	760	18	PRDSR-72	1587	36							24 lbs.	6
84"	PRSSR-84	802	21	PRDSR-84	1758	42							28 lbs.	7
96"	PRSSR-96	842	24	PRDSR-96	1913	48							32 lbs.	8

## Hang-On Style Speed Rails

- Designed To Hang-on The First Tier Of Any PRSSR Series Speed Rails
- Doubles Liquor Storage
- Removable

**Not To Be Used With Any Other Manufacturers Speed Rails**

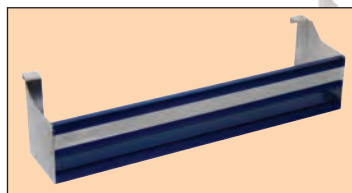

L	Model #	Price	Cap.	Approx. Wt.	Approx. Cu. Ft.
12"	PRHSR-12	\$590	3	4 lbs.	1
18"	PRHSR-18	611	4	4 lbs.	2
24"	PRHSR-24	632	6	5 lbs.	2
30"	PRHSR-30	676	7	6 lbs.	2
36"	PRHSR-36	676	9	6 lbs.	3
42"	PRHSR-42	695	10	7 lbs.	3
48"	PRHSR-48	722	12	7 lbs.	4

For Prestige Liquor Racks & Cabinets, See Page 107.

## BLENDER SHELVES

Mounts To The Front Apron Of Ice Bin

- All Stainless Steel Construction
- 10" Wide
- Grommet Hole For Blender Power Cords
- 15A - 120V Duplex Outlet Hidden Beneath Blender Shelf
- Keyhole Installation



15A - 120V Duplex Receptacle Hidden Beneath Blender Shelf



**EXCLUSIVELY**

For Prestige Underbar Equipment

PRA-BS-12	12" Shelf	\$683
PRA-BS-18	18" Shelf	709
PRA-BS-24	24" Shelf	765
PRA-BS-30	30" Shelf	781

For Free-Standing Blender Stations, See Page 115.

# UNDERBAR ACCESSORIES

## Underbar Modifications & Accessories

### More Underbar Accessories

A-1	Perforated Cover for 10" x 14" x 10" Sink Bowl	.....	<b>\$180</b>
A-8	24" Condiment Rack (5 Condiment Cups) Condiment Racks Hang On Backsplash Of Ice Bin	.....	<b>878</b>
SU-17	Interior Partition (For Underbar Basics & Prestige Drainboard Cabinets - Factory Installed Only)	.....	<b>314</b>
K-12	Replacement Deck Mounted Soap Dispenser	.....	<b>222</b>
SU-55	Removable Stainless Steel Divider For Beer Box	.....	<b>252</b>

### Underbar Modifications

A-51	6" Hole In Drainboard Surface (Waste Chute Installation)	.....	<b>218</b>
PR-STRAP	Stainless Steel Straps For Speed Rails (Set of 2 - For KS-2K Speed Rail Only)	.....	<b>71</b>
SU-4	Modify Prestige Series Backsplash to 4" Tall	.....	<b>35 Lin. Ft.</b>
SU-10A	Upgrade To S/S Legs & Bullet Feet (18" Legs - Includes Adjustable Front-to-Back Cross-Bracing)	.....	<b>378 Pair</b>
SU-10B	Upgrade To S/S Legs & Bullet Feet (10" Legs - Includes Adjustable Front-to-Back Cross-Bracing)	.....	<b>364 Pair</b>
SU-10C	Upgrade To S/S Legs & Bullet Feet (14" Legs - Includes Adjustable Front-to-Back Cross-Bracing)	.....	<b>378 Pair</b>
SU-13	Upgrade to 10-Circuit Cold Plate (Applies to units with 7-Circuit Cold Plate)	.....	<b>669</b>
SU-18RorL	Right or Left Welded Side Splash for 18" Wide Unit	.....	<b>240</b>
SU-18RL	Right & Left Welded Side Splash for 18" Wide Unit	.....	<b>486</b>
SU-21RorL	Right or Left Welded Side Splash for 21" Wide Unit	.....	<b>263</b>
SU-21RL	Right & Left Welded Side Splash for 21" Wide Unit	.....	<b>473</b>
SU-22A	Add 10"x14"x10" Sink To Drbd. Cabinet (Includes Splash Mt. Faucet)	.....	<b>1382</b>
SU-22C	Add 9" x 9" x 4" Sink To Drbd. Cabinet (Includes Splash Mt. Faucet)	.....	<b>1382</b>
SU-24	Provision To Connect Underbar Equipment (Price Per Every Two Units)	.....	<b>209</b>
SU-30	Soda Chase Provision - Tip-Out (For Ice Bins w/ Backsplash Only)	.....	<b>669</b>
SU-33	Working Height to Underbar Equipment	.....	<b>142</b>
SU-34	Top Cutout for Under Bar Equipment	.....	<b>142</b>
SU-36	Add 5-1/2" Diameter Waste Chute (Blender Stations & Drainboard Cabinets Only)	.....	<b>1143</b>
SU-40	Prep Unit For Installation Of Speed Rails	.....	<b>122</b>
SU-41	Make Speed Rail An Odd Length	.....	<b>101</b>
SU-42	Make Speed Rail Accommodate 1/2 Gallon Bottles	.....	<b>134</b>
SU-49	Add A 7-Circuit Cold Plate To D-24-WSIBL2 Or SLC/CRC Series Ice Bins	.....	<b>2713</b>
SU-61	Special Sizing To Reduce Length	.....	<b>N/C</b>
SU-61A	Special Modification	.....	<b>373</b>
SU-62C	Recess GFI Outlet For Bar Die	.....	<b>719</b>
SU-68	Omit Corrugation On Drainboard (Flat Top Work Surface)	.....	<b>217</b>
SU-79	Additional Drainboard Length (Flat Top Work Surface)	.....	<b>205 Lin. Ft.</b>

### BASICS SINGLE SODA GUN HOLDER (Holds One Gun On One Side)

Model #	Price	Size* L x W x H	Approx. Weight	Approx. Cu. Ft.
CRSH-4	<b>912</b>	21" x 4" x 36"	19 lbs.	3
CRSH-6	<b>912</b>	21" x 6" x 36"	19 lbs.	3

### PERFORATED BASKETS FOR UNDERBAR SINKS



**A-16 \$458**  
Fits 10" x 14" x 7" &  
10" x 14" x 10" Sinks

**A-17 \$451**  
Fits 9 1/2" x 11 1/2" x 6" Sink  
**A-17A \$462**  
Fits 9" x 9" x 4" Sink

**A-23 \$434**  
Fits 6" x 11" x 6" Sink

### REMOVABLE BLACK PLASTIC BOTTLE RACKS



**A-19 \$24 ea.**  
Single Bottle Rack  
5 1/4" x 5 1/4"

**A-20 \$74 ea.**  
3-Pack Bottle Rack  
(6 Per Carton. Must Order in Qtys. of 6)  
5 1/4" x 15 7/8"

**A-18 \$64 ea.**  
4-Pack Bottle Rack  
5" x 16 1/2"

### STAINLESS STEEL FALSE BOTTOM



**A-41** For 24" Ice Bin..... **\$369**  
**A-42** For 30" Ice Bin..... **383**  
**A-43** For 36" Ice Bin..... **404**  
**A-44** For 42" Ice Bin..... **418**  
**A-45** For 48" Ice Bin..... **433**

### SLIDING STAINLESS STEEL COVER For Free-Standing Underbar Basics Ice Bins



**SSC-12** For 12" Ice Bin ..... **\$252**  
**SSC-24** For 24" Ice Bin ..... **281**  
**SSC-30** For 30" Ice Bin ..... **312**  
**SSC-36** For 36" Ice Bin ..... **334**  
**SSC-42** For 42" Ice Bin ..... **381**  
**SSC-48** For 48" Ice Bin..... **393**  
**SSC-PT** For Pass-Thru Ice Bin..... **503**

Replacement Sliding S/S Covers For Drop-in Ice Bins, See Page 92

### STAINLESS STEEL ICE BIN PARTITION



14 3/4" Wide  
**A-38** 8" High ..... **\$183**  
**A-39** 12" High ..... **183**  
**A-40** 16" High ..... **183**

### BLENDER SHELF



**A-24 \$352**  
• 8" x 8" Add-On Blender Shelf  
• Duplex GFI Outlet Beneath Shelf  
• Grommet Hole For Power Cord

### WRIST HANDLES FOR FAUCETS



**K-316-LU \$175**  
Add Wrist Handles  
For Deck Or Splash Mt. Faucets  
Set Of 2

# UNDERBAR ACCESSORIES

## Prestige Underbar Modifications & Accessories

### Prestige Ice Bin Accessories



<b>PRA-BR-3</b>	3-Bottle Well Support Frame For Ice Bin <i>(For 20" Wide Units &amp; Required For Use w/ Cover - Bottle Wells Not Included - Use A-20)</i>	.....	<b>\$175</b>
<b>PRA-2405</b>	24" Condiment Rack (Five 1/9" Removable Plastic Condiment Cups. Racks Hang On Backsplash Of Ice Bin)	.....	<b>760</b>

### Prestige Bar Sink Accessories

<b>SU-20RorL</b>	Right or Left Side Splash for 20" Wide Unit	.....	<b>268</b>
<b>SU-20RL</b>	Right & Left Side Splash for 20" Wide Unit	.....	<b>530</b>
<b>SU-25RorL</b>	Right or Left Side Splash for 25" Wide Unit	.....	<b>319</b>
<b>SU-25RL</b>	Right & Left Side Splash for 25" Wide Unit	.....	<b>712</b>

### Prestige Underbar Modifications

<b>SU-4</b>	Modify Prestige Series Backsplash to 4" Tall	.....	<b>35</b>	<b>Lin. Ft.</b>
<b>SU-12A</b>	13" S/S "H" Leg Assembly <i>(Includes Adjustable Front-to-Back Cross-Bracing)</i>	.....	<b>364</b>	<b>Pair</b>
<b>SU-12B</b>	S/S "H" Leg Assembly For Extra Deep Ice Bins <i>(Includes Adjustable Front-to-Back Cross-Bracing)</i>	.....	<b>364</b>	<b>Pair</b>
<b>SU-27</b>	Cabinet Door Lock w/ Key	.....	<b>474</b>	
<b>SU-30</b>	Soda Chase Provision <i>(For Ice Bins w/ Backsplash Only)</i>	.....	<b>669</b>	
<b>SU-36</b>	Add Waste Chute (Blender Stations Only)	.....	<b>1143</b>	
<b>SU-44</b>	Add S/S Glass Rack Slides <i>(Prestige Glass Rack Storage Cabinets Only)</i>	.....	<b>819</b>	<b>2/Set</b>
<b>SU-46</b>	Add S/S Full Extension Roller Slides <i>(Prestige Glass Rack Storage Cabinets Only)</i>	.....	<b>1365</b>	
<b>SU-47</b>	Add S/S Concealing Drawer Front <i>(Prestige Glass Rack Storage Cabinets Only)</i>	.....	<b>684</b>	
<b>SU-62C</b>	Recess GFI Outlet For Bar Die <i>(Wiring by Others)</i>	.....	<b>719</b>	
<b>SU-73</b>	Add Mirror Finish <i>Factory Install Only</i>	.....	<b>611</b>	
<b>SU-74</b>	All Stainless Steel Construction Upgrade	.....	<b>727</b>	
<b>SU-75</b>	Add Welded Stainless Steel Cross-Bracing	.....	<b>174</b>	
<b>SU-77</b>	Modify Cabinet to be 25" Wide <i>(Prestige Drainboard Cabinets Only)</i>	.....	<b>125</b>	



### TUBING CHASE

<b>PRA-19-TC</b>	For 20" Unit.....	<b>\$302</b>
<b>PRA-24-TC</b>	For 25" Unit.....	<b>315</b>

### STAINLESS STEEL TRASH RECEPTACLE COVER

*Trash Bin Not Included • Factory Install Only*



### PRST-12 \$1044

- Open Unit
- Accommodates Slim Jim® Trash Can Measuring 11" x 20" x 25" (15 7/8 Gallon Capacity)\*
- Units Mount Between Equipment Line Up
- Overall Size: 12" x 25" x 21"
- 33 lbs. 4 Cu. Ft.

### SLIDING STAINLESS STEEL COVERS For Ice Bins



<b>PRA-SSC-12</b>	Fits 12" Ice Bin	.....	<b>\$289</b>
<b>PRA-SSC-18</b>	Fits 18" Ice Bin	.....	<b>293</b>
<b>PRA-SSC-24</b>	Fits 24" Ice Bin	.....	<b>299</b>
<b>PRA-SSC-30</b>	Fits 30" Ice Bin	.....	<b>326</b>
<b>PRA-SSC-36</b>	Fits 36" Ice Bin	.....	<b>351</b>
<b>PRA-SSC-42</b>	Fits 42" Ice Bin	.....	<b>440</b>
<b>PRA-SSC-48</b>	Fits 48" Ice Bin	.....	<b>452</b>
<b>PRA-SSC-PT30</b>	Fits PR-44X30SP-10L or R & PR-42X30-10L or R	.....	<b>645</b>
<b>PRA-SSC-PT42</b>	Fits PRPT-2442, PRPT-2442-10, PR-44X42SP-10L or R & PR-42X42-10L or R	.....	<b>692</b>

## PRESTIGE SODA GUN HOLDER

Mounts In Prestige Underbar Line Up

- Provides Housing For WunderBar® Soda Gun (14 Button or Smaller)
- Built-In Soda Gun Holder with Drip Cup
- Cover Allows Easy Access To Make Adjustments
- Keeps Tubing Lines Hidden For A Cleaner Workspace
- Includes Backsplash



### SINGLE SODA GUN HOLDER (Holds One Gun On One Side)

Model #	Price	Size* L x W x H	Approx. Weight	Approx. Cu. Ft.
<b>PRSH-19-4</b>	<b>\$1153</b>	20" x 4" x 36"	19 lbs.	3
<b>PRSH-19-6</b>	<b>1153</b>	20" x 6" x 36"	19 lbs.	3
<b>PRSH-24-4</b>	<b>1239</b>	25" x 4" x 36"	20 lbs.	3
<b>PRSH-24-6</b>	<b>1239</b>	25" x 6" x 36"	20 lbs.	3



\*Height is from the finished floor to the top of the splash

NOTE: Drain Connection Is Required On Drip Cup

## PRESTIGE UNDERBAR ADD-ONS

### Stainless Steel Underbar Fillers

*Multiple Angles Available • Optional Legs*

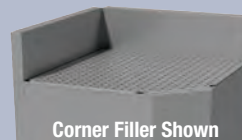

Corner Filler Shown

- Removable Perforated Drainboard Top
  - Bolt On To Sides Of Equipment
  - For Odd Shape Underbar Line Ups
- See Page 109



### Stainless Steel Base Cabinet

*Available With Or Without Doors*

- Provides Extra Storage In Bar Line Up
- Optional Door Lock

Contact Our SmartFab Department For Details & Pricing.  
SmartFab@advancetabco.com • 800-645-3166

# FAUCETS

## Underbar Equipment Faucets

All Items on This Page Ship via UPS

All Faucets Meet Federal Lead Free Standards

### UNDERBAR DECK MOUNTED SINK FAUCETS

**IMPROVED!**  
Stronger Actuator

6" Deck Mounted Faucet



K-51 **\$696**  
4" O.C.

3-1/2" Gooseneck



K-52 **\$348**  
4" O.C.

12" Swing Spout



K-53 **\$657**  
4" O.C.

Water Filler Faucet



K-54  
8-1/4" High **\$781**  
K-54A  
13" High **\$887**

Deck Mt. 6" Extended Spout 4" O.C.



K-124 **\$503**

K-208 **\$686**  
With Wrist Handles

Dipper Well Faucet



A-33 **\$235**

Gooseneck Deck Mount Melt Down Nozzle 4" O.C.



A-29 **\$769** A-30 **\$878** (Installed)

### UNDERBAR SPLASH MOUNTED SINK FAUCETS

3-1/2" Splash Mounted Faucet



K-59 **\$348**  
4" O.C.

Extra Heavy Duty Splash Mounted Faucet



K-69 **\$684**  
4" O.C.

Splash Mt. 6" Extended Spout 4" O.C.



K-123 **\$518**

Splash Mt. 6" Extended Spout with Wrist Handles



K-206 **\$655**  
4" O.C.

6" Splash Mounted Faucet



K-125 **\$454**  
4" O.C.

10" Splash Mounted Spout



K-126 **\$454**  
4" O.C.

Wrist Handles for Faucets  
(Excludes K-69)  
K-316-LU **\$175**



### UNDERBAR SINK ACCESSORIES

#### WASTE OUTLETS & CHUTES

1" Waste Outlet



A-10 **\$27 ea.**

1-1/2" Waste Outlet



K-63 (formally A-11) **\$57**

6" Stainless Steel Open Waste Chute  
Fits 6" Dia. Cutout



A-6 **\$191**

6" Dipper Well with Insert and Drain  
Fits 6" Dia. Cutout



A-7 **\$500**

1-1/2" NPT Drain Connection

Add SU-34 Cutout for A-6 or A-7 **\$142**

#### STAINLESS STEEL OVERFLOW PIPES



1" Pipe  
(6 per carton)



1-1/2" Pipe  
(6 per carton)

A-12 **\$27 ea.** A-13 **\$29 ea.**

(Price per each, sold in a carton of 6.  
Broken carton price \$25.00 list per each)

#### SOAP DISPENSERS & HOLDERS

Deck Mounted Soap Dispenser

K-12 **\$222**



Chrome Towel Ring  
(Packed Loose)

A-15 **\$143**



# PORTABLE BARS

## Heavy Duty Portable Bars

**ALL STAINLESS STEEL INTERIOR!** Designed For Heavy-Duty, High Volume Operation!

### HEAVY DUTY OPEN BASE

- All Stainless Steel Bartender Side
- 19" x 13-1/2" x 11" Stainless Steel Integral Insulated Ice Bin with Cover
- Full Perimeter Bumpers
- 5" Heavy Duty Swivel Plate Casters (2 w/ Brakes)

- Drain & Shut-Off Valve
- Stainless Steel Speed Rails
- Open Bottom Shelf For Glass Rack Storage



Bar Top, Front, & Sides Material	Model	Price	Length	Width	Bar Top Width	# Of Speed Rails	Speed rail Capacity	Wt.	Cu. Ft.
Black Mica	AMS-5B	\$9020	62 1/4"	27 1/4"	12"	2	10 Btls.	315 lbs.	70
Black Mica	AMS-6B	10021	74 3/8"	27 1/4"	12"	3	15 Btls.	399 lbs.	73

### HEAVY DUTY WITH DOORS

- All Stainless Steel Bartender Side
- 19" x 13-1/2" x 11" Stainless Steel Integral Insulated Ice Bin With Cover
- Full Perimeter Bumpers
- 5" Heavy Duty Swivel Plate Casters (2 w/ Brakes)
- Drain & Shut-Off Valve

- Stainless Steel Speed Rails
- Bottom Shelf For Glass Rack Storage
- Center Stainless Steel Panel For Extra Support
- Hinged Door With Lock On Left & Right Side Of Center Support Panel



Bar Top, Front, & Sides Material	Model	Price	Length	Width	Bar Top Width	# Of Speed Rails	Speed rail Capacity	Wt.	Cu. Ft.
Black Mica	AMD-5B	\$10057	62 1/4"	28 1/8"	12"	2	10 Btls.	423 lbs.	71
Black Mica	AMD-6B	11061	74 3/8"	28 1/8"	12"	3	15 Btls.	464 lbs.	73

**Upgrade with Cold Plates - Add suffix -7 after model # and add \$2115 to Bars cost. See Page 122 For All Portable Bar Modifications & Accessories.**

## Laminates & Stainless Steel Panels for Portable Series Bars

Add model number at end of Portable bar model number when ordering & add additional cost.  
(Example: AMD-6B-LCW)



**-LMP Add \$2818**  
Marula Pine  
Exterior front & sides only



**-LCW Add \$2818**  
Columbian Walnut  
Exterior front & sides only



**-LCM Add \$2818**  
Calcutta Marble  
Exterior front & sides only



**-SS Add \$4927**  
All Stainless Steel  
Including Top



### Need a Custom Color or Magnetic Signage?

Add below model number to your Portable Bar order

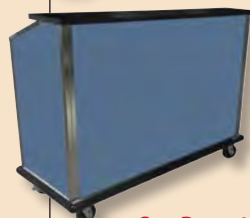

**Custom Colors Available**  
SU-81  
Consult Factory For Pricing & Details



**Removable Magnetic Signage**  
SU-81M  
\$800 each  
Includes Custom Graphics.

See Page 122 For Even More Options

# PORTABLE BARS

## Portable Bars



**Designed For Heavy-Duty Use.  
Perfect for High Volume Operation!**

### STANDARD BLACK MICA BAR

- All Black Mica Finish
- Stainless Steel Countertop
- 19" x 13-1/2" x 11" Stainless Steel Integral Insulated Ice Bin With Cover
- Drain & Shut-Off Valve
- Open Bottom Shelf For Glass Rack Storage
- Towel Ring
- Dual Plastic Speed Rails (10 Bottle Capacity)
- 4" Swivel Plate Casters (2 w/ Brakes)

Top, Front, Back & Sides Material	Model	Price	Length	Width	Bar Top Width	Wt.	Cu. Ft.
Black Mica	D-B	<b>\$7125</b>	61"	24.50"	11"	310 lbs.	60



D-B Bartender Side Shown

### BAR WITH ALL STAINLESS STEEL WORK AREA

- Stainless Steel Countertop, Backsplash & Inside Side Panels
- 19" x 13-1/2" x 11" Stainless Steel Integral Insulated Ice Bin With Cover
- Dual Plastic Speed Rails (10 Bottle Capacity)
- Open Bottom Shelf & Mid Shelf For Glass Rack Storage
- 5" Heavy Duty Swivel Plate Casters (2 w/ Brakes)
- 2 Towel Rings

Top, Front, Back & Sides Material	Model	Price	Length	Width	Bar Top Width	Wt.	Cu. Ft.
Black Mica	R-8-B	<b>\$15154</b>	95.75"	24.50"	12"	550 lbs.	625



R-8-B Bartender Side Shown

### Portable Bar Modifications & Accessories



BK-2



DT-2



SU-80



-7

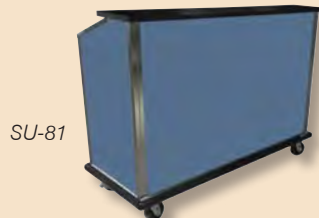

SU-81

-7 7-Circuit Cold Plate Sealed Into Bottom ..... **\$2589**  
Of Ice Bin Add The Suffix -7 To The Model Number & Add To Cost (Factory Installed Only)

BK-2 Stainless Steel Speed Rail ..... **152**

DT-2 Double Tier Stainless Steel ..... **287**  
Speed Rail

SU-80 Continuous Bumper on 3 Sides..... **1446**

SU-81 Custom Mica Colors Or S/S Panels ..... **Call Factory**

*Custom Colors Include Exterior Finishes Only (Bar Front And Sides. Additional Charge For Bar Top. All Interiors Are Standard Black Finish, Excluding AMS & AMD Series)*

**See Page 125 For Optional Laminates & Stainless Steel Options**

# ADVANCE TABCO HOT & COLD FOOD TABLES & DROP-INS

## Features:

- Stainless Steel Body, Top & Sides
- Fiberglass Insulation (Excludes Solid Top Tables)
- 1" I.P.S. Drain (Excludes Solid Top Tables)
- Galvanized Legs with Adjustable Bullet Feet

### Refrigerated & Hot Well Drop-Ins



### Electric & Gas Hot Food Tables



### Solid Top Tables



### Everyday Buffet Tables



### Ice-Cooled Tables



### Refrigerated Tables



### Sealed Wells

These units allow water to be poured directly into the unit and get heated. Food bins may be used without the use of a Spillage Pan.



### Standard Wells

Never pour water directly into these type of units. To use hot water in these units, must use with **Model# SP-A** Aluminum Spillage Pans or **Model # SP-S** S/S Spillage Pans.



### Refrigerated

These units are designed to maintain chilled foods at the proper temperature.

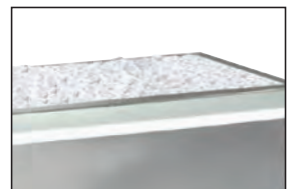

### Non-Refrigerated

Units are designed to cool foods already chilled using only ice within its insulated bin. There is no refrigeration unit in this equipment.



# HOT WELL DROP-INS

## Electric Sealed Well Hot Food Drop-In Units

- 304 Stainless Steel Top
- Fiberglass Insulation Between Compartments
- 12" X 20" Die Stamped Pan Openings
- 6" Deep Units

- 1" I.P.S. Drain
- Remote Control Panel
- Infinite Control Knobs
- Indicator Lights

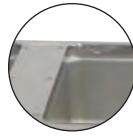

Individual Sealed Well Compartments



DISW-3-120 Shown

### STANDARD DROP-IN UNITS

Model #	Price	Length	Width	# of Wells	Cut-Out Size W x L	Volts	Amps	Watts	Approx. Wt.	Cu. Ft.
DISW-1-120	<b>\$3234</b>	15-1/2"	24-1/2"	1	23-1/2" x 15-5/8"	120	9.17	1100	73 lbs.	6
DISW-2-120	<b>4680</b>	30-1/2"	24-1/2"	2	23-1/2" x 29-5/8"	120	12.34	2200	110 lbs.	6
DISW-3-120	<b>5681</b>	44-1/2"	24-1/2"	3	23-1/2" x 43-5/8"	120	27.51	3300	135 lbs.	6
DISW-1-240	<b>3234</b>	15-1/2"	24-1/2"	1	23-1/2" x 15-5/8"	208/240	3.97/4.58	825/1100	73 lbs.	6
DISW-2-240	<b>4680</b>	30-1/2"	24-1/2"	2	23-1/2" x 29-5/8"	208/240	7.94/9.16	1650/2200	110 lbs.	6
DISW-3-240	<b>5681</b>	44-1/2"	24-1/2"	3	23-1/2" x 43-5/8"	208/240	11.91/13.74	2475/3300	135 lbs.	18
DISW-4-240	<b>6747</b>	58-1/2"	24-1/2"	4	23-1/2" x 57-5/8"	208/240	15.88/18.32	3300/4400	180 lbs.	23
DISW-5-240	<b>8786</b>	72-1/2"	24-1/2"	5	23-1/2" x 71-5/8"	208/240	19.85/22.90	4125/5500	208 lbs.	35
DISW-6-240*	<b>10360</b>	86-1/2"	24-1/2"	6	23-1/2" x 85-5/8"	208/240	23.82/27.48	4950/6600	275 lbs.	35

\*6-well unit include two sets of control panels

**NOTE:** Units are not designed to cook or heat frozen or refrigerated foods. Food placed in tables should already be hot, and the table will maintain the proper temperatures



DISLSW-2-120 Shown

### SLIMLINE DROP-IN UNITS

Model #	Price	Length	Width	# of Wells	Cut-Out Size W x L	Volts	Amps	Watts	Approx. Wt.	Cu. Ft.
DISLSW-2-120	<b>\$5174</b>	46-1/2"	16-1/2"	2	15-1/4" x 45-1/4"	120	18.34	2200	95 lbs.	11
DISLSW-3-120	<b>6210</b>	68-1/2"	16-1/2"	3	15-1/4" x 67-1/4"	120	27.51	3300	125 lbs.	11
DISLSW-2-240	<b>5174</b>	46-1/2"	16-1/2"	2	15-1/4" x 45-1/4"	208/240	3.94/9.16	1600/2200	95 lbs.	18
DISLSW-3-240	<b>6210</b>	68-1/2"	16-1/2"	3	15-1/4" x 67-1/4"	208/240	11.90/13.34	2475/3300	150 lbs.	18
DISLSW-4-240	<b>8720</b>	90-1/2"	16-1/2"	4	15-1/4" x 89-1/4"	208/240	15.88/18.32	3300/4400	155 lbs.	23

### Drop-In Unit Options & Accessories

OPTIONAL NEMA 8' CORD WITH PLUGS AVAILABLE:

Drop-In Units to be hard wired in the field. Please consult the factory for more information.



**NEMA 5-15P**  
**SU-P-234 \$234**

1 Well, 120-240v Units



**NEMA L5-30P**  
**SU-P-231 \$420**

4 Well, 120v Units

(6 well unit requires 2 Cords)



**NEMA 6-20P**  
**SU-P-232 \$151**

2 or 3 Well, 240v Units

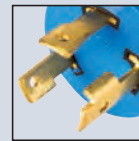

**NEMA L6-30P**  
**SU-P-233 \$385**

4, 5 or 6 Well, 240v Units

#### Autofill Upgrade

Automatically fills & maintains water level. For DISW, DISLSW, SW & HDSW Series. Requires added cost Manifold Drain Assembly (Except HDSW series). See below.

**SU-90 \$3049** Autofill Only

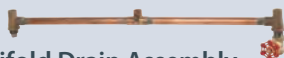

#### Manifold Drain Assembly

Add The Suffix **-M** To The Model Number And Add Additional Pricing Below.

**\$373** Per Well

#### Filler Faucet

- Hot Water Supply Only
- Requires **-M** Manifold Drain Assembly
- Faucet Location To Be Specified When Ordering

**K-49 \$573**



#### 3-Phase Upgrade

Upgrade 240 volt units to 3 Phase Wiring.

**SU-72 \$725** Per Unit

#### Thermostatic Controls

Add The Suffix **-T** To The Model Number And Add Additional Pricing Below.

**\$328** Per Well



# HOT FOOD TABLES



## Electric Hot Food Tables

- Stainless Steel Body & Top
- Galvanized Legs, Undershelf & Adjustable Bullet Feet
- Enclosed Base Units Include Stainless Steel Body & Shelf
- Fiberglass Insulation Between Each Compartment
- 8" Wide Poly Cutting Board Shelf - Ships K.D.
- Galvanized Liner. (Optional Stainless Steel Liner upgrade available **Model # SU-32 \$186 per well**)
- Infinite Control Knobs & Indicator Lights
- Single Phase Wiring (Upgrade to 3 Phase Wiring for 240 Volt Units- **Model # SU-72 \$725**)



w/ Undershelf  
HF-2E-240 Shown

### Undershelf

Model #	Price	Length	Width*	# of Wells	Volts	Amps	Watts	NEMA Plug	Wt.	Cu. Ft.
HF-2E-120	<b>\$3224</b>	31-13/16"	30-5/8"	2	120	8.33	1000	5-20P	92 lbs.	28
HF-3E-120	<b>3473</b>	47-1/8"	30-5/8"	3	120	12.50	1500	5-20P	130 lbs.	41
HF-4E-120	<b>4700</b>	62-7/16"	30-5/8"	4	120	16.67	2000	L5-30P	152 lbs.	55
HF-2E-240	<b>3224</b>	31-13/16"	30-5/8"	2	208/240	7.21/8.33	1500/2000	6-20P	92 lbs.	28
HF-3E-240	<b>3473</b>	47-1/8"	30-5/8"	3	208/240	10.82/12.50	2250/3000	6-20P	120 lbs.	41
HF-4E-240	<b>4700</b>	62-7/16"	30-5/8"	4	208/240	14.42/16.67	3000/4000	L6-30P	152 lbs.	55
HF-5E-240	<b>6213</b>	77-3/4"	30-5/8"	5	208/240	18.03/20.84	3750/5000	L6-30P	170 lbs.	67

\*Width Includes 8" Cutting Board

See Below For Stainless Steel Legs & Undershelf Upgrade

### Enclosed Base

Model #	Price	Length	Width*	# of Wells	Volts	Amps	Watts	NEMA Plug	Wt.	Cu. Ft.
HF-2E-120-BS	<b>\$6240</b>	31-13/16"	30-5/8"	2	120	8.33	1000	5-20P	92 lbs.	28
HF-3E-120-BS	<b>6879</b>	47-1/8"	30-5/8"	3	120	12.50	1500	5-20P	210 lbs.	41
HF-4E-120-BS	<b>8354</b>	62-7/16"	30-5/8"	4	120	16.67	2000	L5-30P	250 lbs.	55
HF-2E-240-BS	<b>6240</b>	31-13/16"	30-5/8"	2	208/240	7.21/8.33	1500/2000	6-20P	92 lbs.	28
HF-3E-240-BS	<b>6879</b>	47-1/8"	30-5/8"	3	208/240	10.82/12.50	2250/3000	6-20P	210 lbs.	41
HF-4E-240-BS	<b>8354</b>	62-7/16"	30-5/8"	4	208/240	14.42/16.67	3000/4000	L6-30P	250 lbs.	55
HF-5E-240-BS	<b>9963</b>	77-3/4"	30-5/8"	5	208/240	18.03/20.84	3750/5000	L6-30P	290 lbs.	67
HF-6E-240-BS	<b>11402</b>	93-1/16"	30-5/8"	5	208/240	18.03/20.84	3750/5000	L6-30P	325 lbs.	88

\*Width Includes 8" Cutting Board



Enclosed Base  
HF-5E-240-BS Shown with  
Optional TA-255P Casters

### Enclosed Base w/ Sliding Doors

Model #	Price	Length	Width*	# of Wells	Volts	Amps	Watts	NEMA Plug	Wt.	Cu. Ft.
HF-2E-120-DR	<b>\$7193</b>	31-13/16"	30-5/8"	2	120	8.33	1000	5-20P	127 lbs.	28
HF-3E-120-DR	<b>8058</b>	47-1/8"	30-5/8"	3	120	12.50	1500	5-20P	155 lbs.	41
HF-4E-120-DR	<b>9526</b>	62-7/16"	30-5/8"	4	120	16.67	2000	L5-30P	197 lbs.	55
HF-2E-240-DR	<b>7193</b>	31-13/16"	30-5/8"	2	208/240	7.21/8.33	1500/2000	6-20P	127 lbs.	28
HF-3E-240-DR	<b>8058</b>	47-1/8"	30-5/8"	3	208/240	10.82/12.50	2250/3000	6-20P	155 lbs.	41
HF-4E-240-DR	<b>9526</b>	62-7/16"	30-5/8"	4	208/240	14.42/16.67	3000/4000	L6-30P	197 lbs.	55
HF-5E-240-DR	<b>11079</b>	77-3/4"	30-5/8"	5	208/240	18.03/20.84	3750/5000	L6-30P	215 lbs.	67
HF-6E-240-DR	<b>12640</b>	93-1/16"	30-5/8"	5	208/240	18.03/20.84	3750/5000	L6-30P	250 lbs.	88

\*Width Includes 8" Cutting Board



w/ Sliding Doors  
HF-5E-240-DR Shown

NOTE: Units are not designed to cook or heat frozen or refrigerated foods. Food placed in tables should already be hot, and the table will maintain the proper temperatures

## Food Table Modifications & Accessories

For Our Full Line Of Hot Food Table Modifications, Accessories & Replacement Parts, See Page 137-140

Stainless Steel Legs & Undershelf Upgrade			
2 Wells	3 Wells	4 Wells	5 Wells
SU-23A <b>\$1134</b>	SU-23B <b>\$1173</b>	SU-23C <b>\$1244</b>	SU-23D <b>\$1399</b>

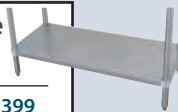

Galvanized Undershelf For Food Tables			
2 Wells	3 Wells	4 Wells	5 Wells
SU-30-UG2 <b>\$392</b>	SU-30-UG3 <b>\$498</b>	SU-30-UG4 <b>\$638</b>	SU-UG5 <b>\$720</b>

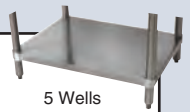

**SU-25S** Add Casters to Food Units w/Undershelf **\$678 Set of 4**  
*(Includes 4 - 5" Swivel Casters, 2 w/ Brakes & Legs that maintain height)*

**TA-255P** Add Casters to Enclosed Base Food Units **981 Set of 4**  
*(Includes 4 -5" Bolted Swivel Casters, 2 w/ Brakes)*

**SU-5G** Replacement Galvanized legs with Bullet Foot For Hot/Ice Cooled Table with Undershelf **106 ea.**  
*(HF, SW, WB, STU or CPU Series)*

**TCB-OMIT** Remove Poly Cutting Board & Shelf **-227 ea.**

**CB-OMIT** Remove Poly Cutting Board Only **-113 ea.**

**SU-19** Prepare Hot Tables To Be Locked Together **\$831 ea.**  
*(One Charge For Each Table To Be Interlocked)*

**SU-32** Upgrade to a Stainless Steel Lining **186 per well**  
*(For Electric Units. Excludes Sealed Hot Well Units)*

**SP-A** Aluminum Spillage Pan **192 ea.**

**SP-S** Stainless Steel Spillage Pan **337 ea.**

**SU-72** Upgrade 240 volt units to 3-Phase Wiring **725 ea.**

# HOT FOOD TABLES

## Electric Sealed Well Hot Food Tables



- Stainless Steel Body & Top
- Galvanized Legs, Undershef & Adjustable Bullet Feet
- Enclosed Base Units Include Stainless Steel Body & Shelf
- Stainless Steel Lining
- Fiberglass Insulation Between Each Compartment
- Drains With Gate Valves Per Well

- 8" Wide Poly Cutting Board Shelf - Ships K.D.
- 8 Ft. Electric Cord w/ Plug Included
- Infinite Control Knobs & Indicator Lights
- Single Phase Wiring (Upgrade to 3 Phase Wiring for 240 Volt Units- **Model # SU-72 \$725**)



Sealed Well with Drain Shown

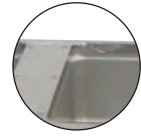

Individual Sealed Well Compartments

### Undershef

Model #	Price	Length	Width*	# of Wells	Volts	Amps	Watts	NEMA Plug	Wt.	Cu. Ft.
SW-2E-120	\$3881	31-13/16"	30-5/8"	2	120	10.67	1280	5-20P	92 lbs.	28
SW-3E-120	4697	47-1/8"	30-5/8"	3	120	16	1920	5-20P	135 lbs.	55
SW-4E-120	6568	62-7/16"	30-5/8"	4	120	21.33	2560	L5-30P	230 lbs.	55
SW-2E-240	3881	31-13/16"	30-5/8"	2	208/240	7.94/9.16	1650/2200	6-20P	92 lbs.	28
SW-3E-240	4697	47-1/8"	30-5/8"	3	208/240	11.91/13.74	2475/3300	6-20P	135 lbs.	41
SW-4E-240	6622	62-7/16"	30-5/8"	4	208/240	15.88/18.32	3300/4400	L6-30P	197 lbs.	55
SW-5E-240	8161	77-3/4"	30-5/8"	5	208/240	19.85/22.90	4125/5500	L6-30P	215 lbs.	67

\*Width Includes 8" Cutting Board

See Below For Stainless Steel Legs & Undershef Upgrade



w/ Undershef  
SW-3E-120 Shown

### Enclosed Base

Model #	Price	Length	Width*	# of Wells	Volts	Amps	Watts	NEMA Plug	Wt.	Cu. Ft.
SW-2E-120-BS	\$7266	31-13/16"	30-5/8"	2	120	10.67	1280	5-20P	127 lbs.	28
SW-3E-120-BS	8346	47-1/8"	30-5/8"	3	120	16	1920	5-20P	155 lbs.	41
SW-4E-120-BS	10259	62-7/16"	30-5/8"	4	120	21.33	2560	L5-30P	197 lbs.	54
SW-2E-240-BS	7266	31-13/16"	30-5/8"	2	208/240	7.94/9.16	1650/2200	6-20P	127 lbs.	28
SW-3E-240-BS	8346	47-1/8"	30-5/8"	3	208/240	11.91/13.74	2475/3300	6-20P	155 lbs.	41
SW-4E-240-BS	10259	62-7/16"	30-5/8"	4	208/240	15.88/18.32	3300/4400	L6-30P	197 lbs.	55
SW-5E-240-BS	12093	77-3/4"	30-5/8"	5	208/240	19.85/22.90	4125/5500	L6-30P	220 lbs.	67
SW-6E-240-BS	13127	93-1/16"	30-5/8"	6	208/240	23.82/27.48	4850/6600	L6-30P	255 lbs.	88

\*Width Includes 8" Cutting Board



Enclosed Base  
SW-5E-240-BS Shown  
with Optional TA-255P Casters

### Enclosed Base w/ Sliding Doors

Model #	Price	Length	Width*	# of Wells	Volts	Volts	Watts	NEMA Plug	Wt.	Cu. Ft.
SW-2E-120-DR	\$8064	31-13/16"	30-5/8"	2	120	10.67	1280	5-20P	145 lbs.	28
SW-3E-120-DR	9865	47-1/8"	30-5/8"	3	120	16	1920	5-20P	157 lbs.	41
SW-4E-120-DR	12120	62-7/16"	30-5/8"	4	120	21.33	2560	L5-30P	187 lbs.	54
SW-2E-240-DR	8064	31-13/16"	30-5/8"	2	208/240	7.94/9.16	1650/2200	6-20P	145 lbs.	28
SW-3E-240-DR	9865	47-1/8"	30-5/8"	3	208/240	11.91/13.74	2475/3300	6-20P	157 lbs.	41
SW-4E-240-DR	12120	62-7/16"	30-5/8"	4	208/240	15.88/18.32	3300/4400	L6-30P	260 lbs.	54
SW-5E-240-DR	13099	77-3/4"	30-5/8"	5	208/240	19.85/22.90	4125/5500	L6-30P	281 lbs.	67
SW-6E-240-DR	14337	93-1/16"	30-5/8"	6	208/240	23.82/27.48	4850/6600	L6-30P	316 lbs.	88

\*Width Includes 8" Cutting Board



w/ Sliding Doors  
SW-5E-240-DR Shown

NOTE: Units are not designed to cook or heat frozen or refrigerated foods. Food placed in tables should already be hot, and the table will maintain the proper temperatures

## Food Table Accessories & Modifications

For Our Full Line Of Hot Food Table Modifications, Accessories & Replacement Parts, See Page 137-140

Stainless Steel Legs & Undershef Upgrade			
2 Wells	3 Wells	4 Wells	5 Wells
SU-23A \$1134	SU-23B \$1173	SU-23C \$1244	SU-23D \$1399

Galvanized Undershef For Food Tables			
2 Wells	3 Wells	4 Wells	5 Wells
SU-30-UG2 \$392	SU-30-UG3 \$498	SU-30-UG4 \$638	SU-UG5 \$720

- T Thermostatic Control (Per Well) **\$328 ea.**
- M Manifold Drains (Per Well) **373 ea.**
- SP-A Aluminum Spillage Pan **192 ea.**
- SP-S Stainless Steel Spillage Pan **337 ea.**
- SU-25S Add Casters to Food Units w/Undershef **678 Set of 4**  
(Includes 4 - 5" Swivel Casters, 2 w/ Brakes & Legs that maintain height)
- TA-255P Add Casters to Enclosed Base Food Units **981 Set of 4**  
(Includes 4 - 5" Bolted Swivel Casters, 2 w/ Brakes)
- SU-5G Replacement Galvanized Legs with Bullet Foot For Hot/Ice Cooled Table with Undershef **106 ea.**  
(HF, SW, WB, STU or CPU Series)

- SU-32G Upgrade to a Stainless Steel Lining **\$176 per well**  
(For Gas Units. Excludes Wetbath Units)
- SU-90 Automatically fills & maintains water level. **3049 Autofill Only**  
For DISW, DISLSW, SW & HDSW Series. Requires added cost Manifold Drain Assembly (Except HDSW series). See page 126.
- K-49 Filler Faucet for Hot Tables **573 ea.**  
(Hot water supply only. Requires -M Manifold Drain & SU-15 Prepare for Filler Faucet Provision)
- SU-15 Prepare Hot food Table For Filler Faucet **1117 ea.**  
(For Gas Units. Excludes Wetbath Units)
- TCB-OMIT Remove Poly Cutting Board & Shelf **-227 ea.**
- CB-OMIT Remove Poly Cutting Board Only **-113 ea.**



# HOT FOOD TABLES

## Gas Powered Hot Food Tables

### For Use with Optional Spillage Pans

- These Units Are Designed For Dry Operation Only.
- Stainless Steel Body & Top
- Galvanized Legs, Undershelf & Adjustable Bullet Feet
- Enclosed Base Units Include Stainless Steel Body & Shelf
- Galvanized Liner. (Optional Stainless Steel Liner upgrade available **Model # SU-32G \$176 per well**)
- 3500 BTU'S Per burner
- Fiberglass Insulation Between Each Compartment
- 8" Wide Poly Cutting Board Shelf - Ships K.D.
- Pilot Indicator Openings
- 1/2" Female NPT Connection To Regulator
- Infinite Control Knobs

Available For Natural Gas (NAT) Or Bottled Gas (LP)

### Undershelf

Model #	Price	Length	Width*	# of Wells	Approx. Weight	Approx. Cu. Ft.
HF-2G-NAT or LP	<b>\$3331</b>	31-13/16"	30-5/8"	2	92 lbs.	28
HF-3G-NAT or LP	<b>3708</b>	47-1/8"	30-5/8"	3	130 lbs.	41
HF-4G-NAT or LP	<b>4502</b>	62-7/16"	30-5/8"	4	165 lbs.	55
HF-5G-NAT or LP	<b>5543</b>	77-3/4"	30-5/8"	5	170 lbs.	67

\*Width Includes 8" Cutting Board

For Stainless Steel Legs & Undershelf Upgrade See Page 128



w/ Undershelf  
HF-3G-NAT Shown

### Enclosed Base

Model #	Price	Length	Width*	# of Wells	Approx. Weight	Approx. Cu. Ft.
HF-2G-NAT or LP-BS	<b>\$5778</b>	31-13/16"	30-5/8"	2	117 lbs.	28
HF-3G-NAT or LP-BS	<b>6068</b>	47-1/8"	30-5/8"	3	145 lbs.	41
HF-4G-NAT or LP-BS	<b>8182</b>	62-7/16"	30-5/8"	4	205 lbs.	55
HF-5G-NAT or LP-BS	<b>9368</b>	77-3/4"	30-5/8"	5	250 lbs.	67

\*Width Includes 8" Cutting Board



Enclosed Base  
HF-5G-LP-BS Shown  
with Optional TA-255P Casters

SU-19 Prepare Hot Tables to be Locked Together **\$831 ea.**

(One Charge For Each Table To Be Interlocked)

NOTE: External pressure regulator is required. 4" WC pressure in for Natural Gas and 10" WC pressure in for LP.

NOTE: Units are not designed to cook or heat frozen or refrigerated foods. Food placed in tables should already be hot, and the table will maintain the proper temperatures

**Sleek Shields™**  
Protected By: Patent No. US 9,010,883 B2

**GLASS FOOD SHIELDS**  
Mounts To Top Of Hot/Cold Food Table

#### Self-Serve Style

- 18" Standard Height (Top of Table To Top)
- 1" Stainless Steel Tubing Posts (1 5/8" Posts Also Available)
- Includes Two 18" W x 16 3/8" H Glass Side Panels
- 1/4" Thick Heat-Tempered Glass Front & Sides
- Shipped KD



Includes TA-47  
Mounting Brackets  
For In-Field Installation



Chamber Lock™  
Allows Front Glass To Lock  
In Place At 15° Intervals



NSG-15-4WELL Shown

15" Wide Stainless Steel Shelf			15" Wide w/ Glass Top			Fits # of Bowls	Approx. Wt.	Approx. Cubes
Model #	Price	O.A. Size L x W x H	Model #	Price	O.A. Size L x W x H			
NSG-15-2WELL	<b>\$5067</b>	31-13/16" x 19 3/4" x 18 3/4"	GSG-15-2WELL	<b>\$6080</b>	31-13/16" x 19 3/4" x 18 3/4"	Fits 2-Well Unit	109 lbs.	15
NSG-15-3WELL	<b>5275</b>	47-1/8" x 19 3/4" x 18 3/4"	GSG-15-3WELL	<b>6308</b>	47-1/8" x 19 3/4" x 18 3/4"	Fits 3-Well Unit	143 lbs.	22
NSG-15-4WELL*	<b>6175</b>	62-7/16" x 19 3/4" x 18 3/4"	GSG-15-4WELL*	<b>6712</b>	62-7/16" x 19 3/4" x 18 3/4"	Fits 4-Well Unit	186 lbs.	29
NSG-15-5WELL**	<b>6744</b>	77-3/4" x 19 3/4" x 18 3/4"	Not Available		Not Available	Fits 5-Well Unit	215 lbs.	38
NSG-15-6WELL**	<b>7470</b>	93-1/16" x 19 3/4" x 18 3/4"	Not Available		Not Available	Fits 6-Well Unit	247 lbs.	47

GSG Series Food Shields are slightly longer than the table they rest on. They will extend about 7/8" on either end

\*3/8" Thick Heat-Tempered Glass Required For Front Glass \*\*Requires a Single Center Post (Factory Print Included)

For Full Line Of Glass Top Food Shields  
& Food Table Accessories, See Page 137-140.

# HOT FOOD TABLES



## Gas Powered Wetbath Tables

- Stainless Steel Body & Top
- Galvanized Legs, Undershef & Adjustable Bullet Feet
- Enclosed Base Units Include Stainless Steel Body & Shelf
- Stainless Steel Liner
- Stainless Steel Dish Shelf
- 8" Wide Poly Cutting Board Shelf - Ships K.D.
- 1/2" Female NPT Connection To Regulator
- Pilot Indicator Openings
- Infinite Control Knobs
- **2 & 3 Comp:** 15,000 BTU's
- **4 & 5 Comp:** 25,000 BTU's

### Filler Faucet K-49 \$573



- Hot Water Supply Only
- Requires **-M** Manifold Drain Assembly & **SU-15** Filler Faucet Provision
- Faucet Location To Be Specified When Ordering

Available For Natural Gas (NAT) Or Bottled Gas (LP)

### Undershef

Model #	Price	Length	Width*	# of Wells	Approx. Weight	Approx. Cu. Ft.
WB-2G-NAT or LP	<b>\$4162</b>	31-13/16"	30-5/8"	2	96 lbs.	28
WB-3G-NAT or LP	<b>4552</b>	47-1/8"	30-5/8"	3	130 lbs.	41
WB-4G-NAT or LP	<b>5258</b>	62-7/16"	30-5/8"	4	157 lbs.	55
WB-5G-NAT or LP	<b>6186</b>	77-3/4"	30-5/8"	5	176 lbs.	67

See Below For Stainless Steel Legs & Undershef Upgrade



w/ Undershef  
WB-4G-LP Shown

### Enclosed Base

Model #	Price	Length	Width*	# of Wells	Approx. Weight	Approx. Cu. Ft.
WB-2G-NAT or LP-BS	<b>\$6642</b>	31-13/16"	30-5/8"	2	145 lbs.	28
WB-3G-NAT or LP-BS	<b>7135</b>	47-1/8"	30-5/8"	3	175 lbs.	41
WB-4G-NAT or LP-BS	<b>7973</b>	62-7/16"	30-5/8"	4	225 lbs.	55
WB-5G-NAT or LP-BS	<b>8918</b>	77-3/4"	30-5/8"	5	296 lbs.	67

\*Width Includes 8" Cutting Board



Enclosed Base  
WB-4G-NAT-BS Shown

NOTE: External pressure regulator is required. 4" WC pressure in for Natural Gas and 10" WC pressure in for LP.

NOTE: Units are not designed to cook or heat frozen or refrigerated foods. Food placed in tables should already be hot, and the table will maintain the proper temperatures

## Food Table Modifications & Accessories

For Our Full Line Of Hot Food Table Modifications, Accessories & Replacement Parts, See Page 137-140

### Galvanized Undershef For Food Tables

2 Wells	3 Wells	4 Wells	5 Wells
SU-30-UG2 \$392	SU-30-UG3 \$498	SU-30-UG4 \$638	SU-UG5 \$720

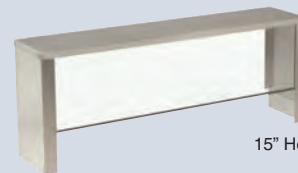
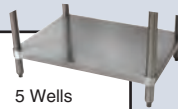

15" Height

### 10" Wide Serving Shelf with Built-In Food Shield

Model	Price	Length	Approx. Wt.	Cu. Ft.
TSS-2	<b>\$1578</b>	31-13/16"	15 lbs.	2
TSS-3	<b>1797</b>	47-1/8"	17 lbs.	3
TSS-4	<b>1959</b>	62-7/16"	19 lbs.	4
TSS-5	<b>2103</b>	77-3/4"	21 lbs.	4
TSS-6	<b>2513</b>	93-1/16"	33 lbs.	5

**SU-15** Prepare Hot Food Table for Filler Faucet (Faucet Not Included. Stationary Models Only) **\$1117 ea.**

**SU-19** Prepare Hot Tables To Be Locked Together **831 ea.**  
(One Charge For Each Table To Be Interlocked)

**SU-25S** Add Casters to Food Units w/Undershef (Includes 4 - 5" Swivel Casters, 2 w/ Brakes & Legs that maintain height) **678 Set of 4**

**TA-255P** Add Casters to Enclosed Base Food Units **981 Set of 4**  
(Includes 4 - 5" Bolted Swivel Casters, 2 w/ Brakes)

**SU-5G** Replacement Galvanized Legs with Bullet Foot For Hot/Ice Cooled Table with Undershef **106 ea.**  
(HF, SW, WB, STU or CPU Series)

**SP-A** Aluminum Spillage Pan **192 ea.**

**SP-S** Stainless Steel Spillage Pan **337 ea.**

**TCB-OMIT** Remove Poly Cutting Board & Shelf **-227 ea.**

**CB-OMIT** Remove Poly Cutting Board Only **-113 ea.**



### Acrylic Side Panel for Serving Shelf

Add side panels to meet additional NSF requirements (1 panel per side)

**TSP-1 \$399 One End**  
**TSP-2 \$818 Two Ends**

Field Installation Available

# SOLID FOOD TABLES

## Solid Top Tables

- Stainless Steel Body & Top
- Galvanized Legs, Undershelf & Adjustable Bullet Feet
- Enclosed Base Units Include Stainless Steel Body & Shelf
- 8" Wide Poly Cutting Board Shelf - Ships K.D.



w/Undershelf  
STU-3 Shown

### Undershelf

Model #	Price	Length	Width*	Wt.	Cu. Ft.
STU-2	<b>\$2082</b>	31-13/16"	30-5/8"	90 lbs.	12
STU-3	<b>2423</b>	47-1/8"	30-5/8"	118 lbs.	17
STU-4	<b>2872</b>	62-7/16"	30-5/8"	150 lbs.	23
STU-5	<b>3619</b>	77-3/4"	30-5/8"	168 lbs.	41

\*Width Includes 8" Cutting Board

For Stainless Steel Legs & Undershelf Upgrade See Page 128



Enclosed Base  
STU-3-BS Shown

### Enclosed Base

Model #	Price	Length	Width*	Wt.	Cu. Ft.
STU-2-BS	<b>\$6748</b>	31-13/16"	30-5/8"	115 lbs.	26
STU-3-BS	<b>7122</b>	47-1/8"	30-5/8"	143 lbs.	36
STU-4-BS	<b>8442</b>	62-7/16"	30-5/8"	185 lbs.	46
STU-5-BS	<b>9414</b>	77-3/4"	30-5/8"	203 lbs.	56

\*Width Includes 8" Cutting Board

### w/ Doors

Model #	Price	Length	Width*	Wt.	Cu. Ft.
STU-2-DR	<b>\$7310</b>	31-13/16"	30-5/8"	125 lbs.	26
STU-3-DR	<b>9873</b>	47-1/8"	30-5/8"	153 lbs.	36
STU-4-DR	<b>9207</b>	62-7/16"	30-5/8"	195 lbs.	46
STU-5-DR	<b>10761</b>	77-3/4"	30-5/8"	213 lbs.	56

\*Width Includes 8" Cutting Board



w/ Doors  
STU-5-DR Shown

- SU-19 Prepare Hot Tables to be Locked Together **\$831 ea.**  
*(One Charge For Each Table To Be Interlocked)*
- TCB-OMIT Remove Poly Cutting Board & Shelf **-227 ea.**
- CB-OMIT Remove Poly Cutting Board Only **-113 ea.**

## Food Table Overshelves

For Our Full Line Of Hot Food Table Modifications, Accessories & Replacement Parts, See Page 137-140



Single Overshelves



Double Overshelves

12" WIDE			18" WIDE			12" WIDE			18" WIDE						
Model	Price	Approx Wt.	Model	Price	Length	Approx Wt.	Cu. Ft.	Model	Price	Approx Wt.	Model	Price	Length	Approx Wt.	Cu. Ft.
STOS-2	<b>\$1268</b>	18 lbs.	STOS-2-18	<b>\$1613</b>	31-13/16"	20 lbs.	3	TOS-2	<b>\$2301</b>	32 lbs.	TOS-2-18	<b>\$2736</b>	31-13/16"	35 lbs.	3
STOS-3	<b>1441</b>	21 lbs.	STOS-3-18	<b>1736</b>	47-1/8"	23 lbs.	4	TOS-3	<b>2686</b>	38 lbs.	TOS-3-18	<b>3157</b>	47-1/8"	41 lbs.	4
STOS-4	<b>1621</b>	24 lbs.	STOS-4-18	<b>1880</b>	62-7/16"	26 lbs.	5	TOS-4	<b>3070</b>	44 lbs.	TOS-4-18	<b>3607</b>	62-7/16"	47 lbs.	5
STOS-5	<b>1756</b>	27 lbs.	STOS-5-18	<b>2052</b>	77-3/4"	30 lbs.	6	TOS-5	<b>3451</b>	49 lbs.	TOS-5-18	<b>4046</b>	77-3/4"	53 lbs.	6
STOS-6	<b>2141</b>	33 lbs.	STOS-6-18	<b>2502</b>	93-1/8"	35 lbs.	6	TOS-6	<b>4213</b>	56 lbs.	TOS-6-18	<b>4938</b>	93-1/8"	61 lbs.	6

# COLD WELL DROP-INS

## Drop-In Cold Pan Units

### ICE-COOLED DROP-IN COLD PAN UNITS



- 304 Stainless Steel Top
- 9" Deep Ice Bin With Fiberglass Insulation
- Black Molding with Thermal Breaker
- 1" I.P.S. Drain

	Model #	Price	Length	Width	Cut-Out Size	Ice Capacity	Approx. Wt.	Cu. Ft.
SLIMLINE	DISLCP-2	\$3591	49 5/8"	18-5/8"	17 3/8" x 48-3/8"	93	168 lbs.	11
	DISLCP-3	4335	71 1/4"	18-5/8"	17 3/8" x 70"	141	178 lbs.	18
	DISLCP-4	4951	92 7/8"	18-5/8"	17 3/8" x 91 5/8"	186	215 lbs.	23
STANDARD	DICP-1	2493	18-13/16"	26 3/4"	25 1/2" x 18 5/8"	45	129 lbs.	6
	DICP-2	2956	34-1/8"	26 3/4"	25 1/2" x 32 1/8"	93	162 lbs.	10
	DICP-3	3387	49-7/16"	26 3/4"	25 1/2" x 45 5/8"	141	165 lbs.	14
	DICP-4	4215	64-3/4"	26 3/4"	25 1/2" x 59 1/8"	188	199 lbs.	18
	DICP-5	4865	80-1/8"	26 3/4"	25 1/2" x 72 5/8"	236	240 lbs.	23
	DICP-6	5357	95-3/8"	26 3/4"	25 1/2" x 86 1/8"	284	268 lbs.	27



**Slimline**  
DISLCP-3 Shown



**Standard**  
DICP-2 Shown

### Optional Adapter Rails & Bars

DICP SERIES			DISLCP SERIES			Description
Model #	Fits Model:	Price	Model #	Fits Model:	Price	
SU-P-501	DICP-1	\$201				Two Left To Right Rails & Two Front-To-Back Supports. Includes Mounting Screws.
SU-P-502	DICP-2	\$300	SU-P-512	DISLCP-2	\$300	Two Left To Right Rails & Three Front-To-Back Supports. Includes Mounting Screws.
SU-P-503	DICP-3	\$401	SU-P-513	DISLCP-3	\$401	Two Left To Right Rails & Four Front-To-Back Supports. Includes Mounting Screws.
SU-P-504	DICP-4	\$500	SU-P-514	DISLCP-4	\$615	Two Left To Right Rails & Five Front-To-Back Supports. Includes Mounting Screws.
SU-P-505	DICP-5	\$601				Two Left To Right Rails & Six Front-To-Back Supports. Includes Mounting Screws.
SU-P-506	DICP-6	\$701				Two Left To Right Rails & Seven Front-To-Back Supports. Includes Mounting Screws.



Left To Right Rails & Front To Back Supports Shown Above

**Horizontal Adapter Bars**  
For Small Pan Sizes

12" x 1"  
Model # SU-45A

Works With Required Rail Kits  
(See Grid Above)



### REFRIGERATED DROP-IN COLD PAN UNITS

- 304 Stainless Steel Top
- 9" Deep Ice Bin With Fiberglass Insulation
- Full Insulation Galvanized Outer Jacket
- Black Molding with Thermal Breaker
- High Cooling Capacity
- Sight Glass To Ensure Proper Charges System
- Low Running Current
- 1" I.P.S. Drain
- Precision Thermostat For Exact Temperature Control
- Includes Adapter Bars For 12" X 20" Food Pans (Pans not Included)
- 8 Ft. Cord & Plug Included



**Slimline**  
DISLRCP-2 Shown

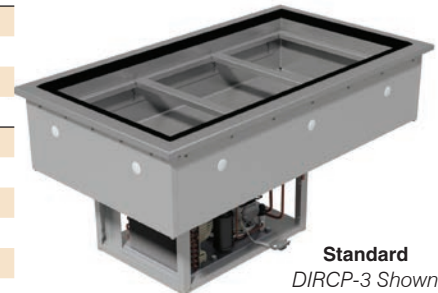

**Standard**  
DIRCP-3 Shown

	Model #	Price	Length	Width	Cut-Out Size	# of Wells	Refrigerant	Approx. Wt.	Cu. Ft.
SLIMLINE	DISLRCP-2	\$9576	49-5/8"	18-5/8"	17-1/8" x 48-3/8"	2	R290	205 lbs.	25
	DISLRCP-3	10756	71-1/4"	18-5/8"	15-3/8" x 70"	3	R290	257 lbs.	31
	DISLRCP-4	11953	92-7/8"	18-5/8"	17-3/8" x 91-5/8"	4	R290	325 lbs.	46
STANDARD	DIRCP-1	7263	20"	26-3/4"	25-1/2" x 18-5/8"	1	R290	163 lbs.	14
	DIRCP-2	7762	33-1/2"	26-3/4"	25-1/2" x 32-1/8"	2	R290	205 lbs.	22
	DIRCP-3	8523	47"	26-3/4"	25-1/2" x 45-5/8"	3	R290	257 lbs.	31
	DIRCP-4	9493	60-1/2"	26-3/4"	25-1/2" x 59-1/8"	4	R290	325 lbs.	39
	DIRCP-5	11123	74"	26-3/4"	25-1/2" x 72-5/8"	5	R290	365 lbs.	47
	DIRCP-6	11924	87-1/2"	26-3/4"	25-1/2" x 86-1/8"	6	R290	398 lbs.	55

**SU-71** 5 Year Extended Parts Warranty on Refrigeration Unit **\$746 Per Unit**  
(Available for Refrigerated Tables & Drop-Ins. See Back Inside Cover For Full Details)



**SU-P-234** - 8' Cord with NEMA 5-15P plug Included

**NOTE: Units are not designed to cool foods originally warm. Food should already be chilled to maintain the proper temperatures**



# COLD FOOD TABLES

## Standard Ice-Cooled Tables

- 304 Stainless Steel Body & Top
- Galvanized Legs, Undershelf & Adjustable Bullet Feet
- Enclosed Base Units Include Stainless Steel Body & Shelf
- Fiberglass Insulation
- 1" I.P.S. Drain
- 8" Wide Poly Cutting Board Shelf - Ships K.D.

### Undershelf

Model #	Price	Length	Width*	Wt.	Cu. Ft.
CPU-2	<b>\$2356</b>	31-13/16"	30-5/8"	90 lbs.	12
CPU-3	<b>3049</b>	47-1/8"	30-5/8"	118 lbs.	18
CPU-4	<b>3694</b>	62-7/16"	30-5/8"	150 lbs.	23
CPU-5	<b>4342</b>	77-3/4"	30-5/8"	168 lbs.	29

\*Width Includes 8" Cutting Board

Stainless Steel Legs & Undershelf Upgrade			
2 Wells	3 Wells	4 Wells	5 Wells
SU-23A <b>\$1134</b>	SU-23B <b>\$1173</b>	SU-23C <b>\$1244</b>	SU-23D <b>\$1399</b>

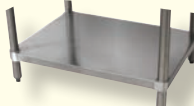

**SU-5G** Replacement Galvanized Legs with Bullet Foot For Hot/Ice Cooled Table with Undershelf (HF, SW, WB, STU or CPU Series) **\$106 ea.**

w/ Undershelf  
CPU-3 Shown



**Optional Adapter Bars**

12" x 1"	20" x 3"
Model # SU-45A	Model # SU-45B
<b>\$84 ea.</b>	<b>\$95 ea.</b>

### Enclosed Base

Model #	Price	Length	Width*	Wt.	Cu. Ft.
CPU-2-BS	<b>\$5854</b>	31-13/16"	30-5/8"	115 lbs.	18
CPU-3-BS	<b>6941</b>	47-1/8"	30-5/8"	143 lbs.	34
CPU-4-BS	<b>8211</b>	62-7/16"	30-5/8"	227 lbs.	44
CPU-5-BS	<b>8672</b>	77-3/4"	30-5/8"	203 lbs.	54

\*Width Includes 8" Cutting Board

### w/ Doors

Model #	Price	Length	Width*	Wt.	Cu. Ft.
CPU-2-DR	<b>\$6168</b>	31-13/16"	30-5/8"	125 lbs.	24
CPU-3-DR	<b>7394</b>	47-1/8"	30-5/8"	153 lbs.	34
CPU-4-DR	<b>8862</b>	62-7/16"	30-5/8"	195 lbs.	44
CPU-5-DR	<b>9432</b>	77-3/4"	30-5/8"	213 lbs.	54

\*Width Includes 8" Cutting Board

Enclosed Base  
CPU-5-BS Shown  
with Optional  
Caster Kit



W/ Doors  
CPU-5-DR  
Shown

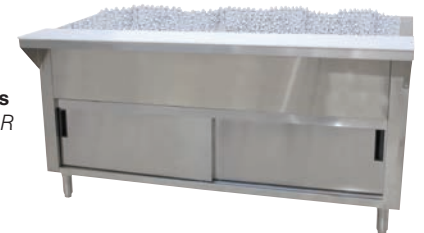

**NOTE: Units are not designed to cool foods originally warm. Food should already be chilled to maintain the proper temperatures**



### CONNECT IT!

Prepare Tables To Be Locked Together While Keeping Them Lined Up! (One Charge For Each Table To Be Interlocked)  
**SU-19 \$831 per table**

## Sleek Shields™

Protected By: Patent No. US 9,010,883 B2

### Self-Serve Style

- 18" Standard Height (Top of Table to Top)
- 1" Stainless Steel Tubing Posts (1 5/8" Posts Also Available)
- Includes Two 18" W x 16 3/8" H Glass Side Panels
- 1/4" Thick Heat-Tempered Glass Front & Sides
- Shipped KD

## GLASS FOOD SHIELDS

Mounts To Top Of Hot/Cold Food Table



Includes TA-47  
Mounting Brackets  
For In-Field Installation



Chamber Lock™  
Allows Front Glass To Lock  
In Place At 15° Intervals



NSG-15-4WELL Shown

15" Wide Stainless Steel Shelf			15" Wide w/ Glass Top			Fits # of Bowls	Approx. Wt.	Approx. Cubes
Model #	Price	O.A. Size L x W x H	Model #	Price	O.A. Size L x W x H			
NSG-15-2WELL	<b>\$5067</b>	31-13/16" x 19 3/4" x 18 3/4"	GSG-15-2WELL	<b>\$6080</b>	31-13/16" x 19 3/4" x 18 3/4"	Fits 2-Well Unit	109 lbs.	15
NSG-15-3WELL	<b>5275</b>	74-1/8" x 19 3/4" x 18 3/4"	GSG-15-3WELL	<b>6308</b>	74-1/8" x 19 3/4" x 18 3/4"	Fits 3-Well Unit	143 lbs.	22
NSG-15-4WELL*	<b>6175</b>	62-7/16" x 19 3/4" x 18 3/4"	GSG-15-4WELL*	<b>6712</b>	62-7/16" x 19 3/4" x 18 3/4"	Fits 4-Well Unit	186 lbs.	29
NSG-15-5WELL**	<b>6744</b>	77-3/4" x 19 3/4" x 18 3/4"	Not Available		Not Available	Fits 5-Well Unit	215 lbs.	38
NSG-15-6WELL**	<b>7470</b>	93-1/16" x 19 3/4" x 18 3/4"	Not Available		Not Available	Fits 6-Well Unit	247 lbs.	47

GSG Series Food Shields are slightly longer than the table they rest on. They will extend about 7/8" on either end

\*3/8" Thick Heat-Tempered Glass Required For Front Glass

\*\*Requires a Single Center Post (Factory Print Included)

For Full Line Of Glass Top Food Shields & Food Table Accessories, See Page 137-140.

# COLD FOOD TABLES

## Mechanically Assisted Cold Pan Tables



### REFRIGERATED COLD PAN TABLES

- 304 Stainless Steel Body, Top and Legs
- Adjustable Bullet Feet
- Heavy Duty Cabinet Base
- 8" Wide Poly Cutting Board Shelf - Ships K.D.
- 1" I.P.S. Drain
- Precision Thermostat For Exact Temperature Control
- High Cooling Capacity
- Sight Glass To Ensure Properly Charges System
- Low Running Current
- 8 Ft. Electric Cord w/ Plug Included
- Includes Adapter Bars For Optional spillage Pans



**Enclosed Base**  
MACP-3-BS Shown

#### Enclosed Base

Model #	Price	Length	Width*	Refrigerant	Wt.	Cu. Ft.
MACP-2-BS	\$14432	31-3/16"	30-5/8"	R290	230 lbs.	39
MACP-3-BS	16293	47-1/8"	30-5/8"	R290	256 lbs.	56
MACP-4-BS	17609	62-7/16"	30-5/8"	R290	380 lbs.	73
MACP-5-BS	19212	77-3/4"	30-5/8"	R290	465 lbs.	90

\*Width Includes 8" Cutting Board



**SU-P-234 - 8' Cord with NEMA 5-15P plug Included**



**Sliding Doors**  
MACP-3-DR Shown

#### w/ Sliding Doors

Model #	Price	Length	Width*	Refrigerant	Wt.	Cu. Ft.
MACP-3-DR	\$16910	47-1/8"	30-5/8"	R290	385 lbs.	41
MACP-4-DR	19580	62-7/16"	30-5/8"	R290	420 lbs.	73
MACP-5-DR	21439	77-3/4"	30-5/8"	R290	505 lbs.	90

\*Width Includes 8" Cutting Board



#### Cold Pan Table Covers

- Stainless Steel
- Plastic Handles
- Piano Hinge(s)
- Fits CPU, MACP & BMACP Units

Model #	Price	Length	Wt.	Cu. Ft.
HC-2	\$581	28-9/16"	12 lbs.	3
HC-3	868	43-7/8"	16 lbs.	4
HC-4	950	59-3/16"	20 lbs.	5
HC-5	1104	74-1/2"	24 lbs.	6

**SU-71 5 Year Extended Parts Warranty on Refrigeration Unit \$716 Per Unit**  
(Available for Refrigerated Tables & Drop-Ins. See Back Inside Cover For Full Details)

**NOTE: Units are not designed to cool foods originally warm. Food should already be chilled to maintain the proper temperatures**

**WARNING:** Refrigerated Equipment on this page may expose you to chemicals, including Ethanes, that are known to the State of California to cause cancer or birth defects or other reproductive harm. For more Info., visit [www.p65warnings.ca.gov](http://www.p65warnings.ca.gov).

## Food Table Shelving

For Our Full Line Of Hot Food Table Modifications, Accessories & Replacement Parts, See Page 139-142



15" Height

#### Single Overshelves

12" WIDE			18" WIDE		
Model	Price	Approx Wt.	Model	Price	Approx Wt.
STOS-2	\$1268	18 lbs.	STOS-2-18	\$1613	20 lbs.
STOS-3	1441	21 lbs.	STOS-3-18	1736	23 lbs.
STOS-4	1621	24 lbs.	STOS-4-18	1880	26 lbs.
STOS-5	1756	27 lbs.	STOS-5-18	2052	30 lbs.
STOS-6	2141	33 lbs.	STOS-6-18	2502	35 lbs.

12" Height

15" Height



#### Double Overshelves

12" WIDE			18" WIDE		
Model	Price	Approx Wt.	Model	Price	Approx Wt.
TOS-2	\$2301	32 lbs.	TOS-2-18	\$2736	35 lbs.
TOS-3	2686	38 lbs.	TOS-3-18	3157	41 lbs.
TOS-4	3070	44 lbs.	TOS-4-18	3607	47 lbs.
TOS-5	3451	49 lbs.	TOS-5-18	4046	53 lbs.
TOS-6	4213	56 lbs.	TOS-6-18	4938	61 lbs.

## Food Table Accessories

- SU-25S** Add Casters to Food Units w/Undershelf **\$678 Set of 4**  
(Includes 4 - 5" Swivel Casters, 2 w/ Brakes & Legs that maintain height)
- SU-25** Add Casters to Food Units w/Undershelf **624 Set of 4**  
(For Units Built Before October 2015. Includes 4 - 5" Swivel Casters, 2 w/ Brakes.)
- TA-25** Replacement Casters For Undershelf Units **624 Set of 4**  
(For Units Built After October 2015. Includes 4 - 5" Swivel Casters, 2 w/ Brakes.)
- TA-255P** Add Casters to Enclosed Base Food Units (Includes 4 - 5" Bolted Swivel Casters, 2 w/ Brakes) **981 Set of 4**

- SU-19** Prepare Hot Tables to be Locked Together **\$831 ea.**  
(One Charge For Each Table To Be Interlocked)
- SU-45A** 12" x 1" Adapter Bar **84 ea.**
- SU-45B** 20" x 3" Adapter Bar **95 ea.**
- TCB-OMIT** Remove Poly Cutting Board & Shelf **-227 ea.**
- CB-OMIT** Remove Poly Cutting Board Only **-113 ea.**

**Sleek Shields™ Are Also Available For Hot & Cold Food Tables. See Pages 140 For Details.**

# HEAVY DUTY TABLES

## Heavy Duty Tables

### HEAVY DUTY ELECTRIC SEALED WELL TABLES

- Heavy Duty Construction 300 Stainless Steel Body, Top and Legs
- Adjustable Stainless Steel Bullet Feet
- 8" Wide Poly Cutting Board Shelf - Ships K.D.
- Sealed Wells w/ Manifold Drains
- Thermostatic Controls
- 8 Ft. Electric Cord w/ Plug Included
- Control Knobs & Indicator Lights
- Removable Front Panel To Access Elements (Upgrade to 3 Phase Wiring for 240 Volt Units- **Model # SU-72 \$658**)



**Enclosed Base**  
HDSW-3-240-BS Shown  
with Optional TA-255P Casters



#### Enclosed Base

Model #	Price	Length	Width*	# of Wells	Volts	Amps	Watts	Wt.	Cu. Ft.
HDSW-2-120-BS	<b>\$13684</b>	31-13/16"	35-3/4"	2	120	10.67	1280	225	31
HDSW-3-120-BS	<b>16489</b>	47-1/8"	35-3/4"	3	120	16	1920	340	45
HDSW-4-120-BS	<b>18968</b>	62-7/16"	35-3/4"	4	120	21.33	2560	430	60
HDSW-2-240-BS	<b>13684</b>	31-13/16"	35-3/4"	2	208/240	7.94/9.16	1650/2200	225	31
HDSW-3-240-BS	<b>16489</b>	47-1/8"	35-3/4"	3	208/240	11.91/13.74	2475/3300	340	45
HDSW-4-240-BS	<b>18968</b>	62-7/16"	35-3/4"	4	208/240	15.88/18.32	3300/4400	430	60
HDSW-5-240-BS	<b>24754</b>	77-3/4"	35-3/4"	5	208/240	19.85/22.90	4125/5500	520	74
HDSW-6-240-BS	<b>28891</b>	93-1/16"	35-3/4"	6	208/240	23.82/27.48	4850/6600	610	88

\*Width Includes 8" Cutting Board

**NOTE: Units are not designed to cook or heat frozen or refrigerated foods. Food placed in tables should already be hot, and the table will maintain the proper temperatures**

#### Autofill Upgrade

Automatically fills & maintains water level. For DISW, DISLSW, SW & HDSW Series. Requires added cost Manifold Drain Assembly (Except HDSW series). See page 126.

**SU-90 \$3049 Upgrade**

#### Filler Faucet

- Hot Water Supply Only 6" Spout
  - Faucet Location To Be Specified When Ordering
  - Requires **-M** Manifold Drain Assembly
  - Add **SU-15 \$1117** for Filler Faucet Provision
- K-49 \$573**



### HEAVY DUTY Refrigerated Cold Well Tables

- Heavy Duty Construction 300 Stainless Steel Body, Top & Legs
- Adjustable Stainless Steel Bullet Feet
- Heavy Duty Cabinet Base
- 1" I.P.S. Drain
- Poly Cutting Board Shelf - Ships K.D.
- High Cooling Capacity
- Includes Adapter Bars For Optional Spillage Pans
- Low Running Current
- Precision Thermostat For Exact Temperature Control
- Single Phase Wiring
- 8 Ft. Electric Cord w/ Plug Included



**Enclosed Base**  
HDRCP-3-BS Shown

Model #	Price	Length	Width*	Refrigerant	Wt.	Cu. Ft.
HDRCP-2-BS	<b>\$21239</b>	31-13/16"	36-1/4"	R290	300 lbs.	39
HDRCP-3-BS	<b>22278</b>	47-1/8"	36-1/4"	R290	420 lbs.	56
HDRCP-4-BS	<b>24754</b>	62-7/16"	36-1/4"	R290	510 lbs.	73
HDRCP-5-BS	<b>28879</b>	77-3/4"	36-1/4"	R290	568 lbs.	90
HDRCP-6-BS	<b>31769</b>	93-1/16"	36-1/4"	R290	633 lbs.	90

\*Width Includes 8" Cutting Board

**SU-71** 5 Year Extended Parts Warranty on Refrigeration Unit **\$746 Per Unit**  
(Available for Refrigerated Tables & Drop-Ins.  
See Back Inside Cover For Full Details)



#### CONNECT IT!

Prepare Tables To Be Locked Together While Keeping Them Lined Up!  
(One Charge For Each Table To Be Interlocked)  
**SU-19 \$831 per table**

**WARNING:** Refrigerated Equipment on this page may expose you to chemicals, including Ethanes, that are known to the State of California to cause cancer or birth defects or other reproductive harm. For more info., visit [www.p65warnings.ca.gov](http://www.p65warnings.ca.gov).

### HEAVY DUTY ICE-COOLED TABLES

- Stainless Steel Body, Top And Legs
- Adjustable Stainless Steel Bullet Feet
- High Cooling Capacity
- Heavy Duty Cabinet Base
- 8" Wide Poly Cutting Board Shelf - Ships K.D.



**Enclosed Base**  
HDCPU-3-BS Shown  
with Optional TA-255P Casters

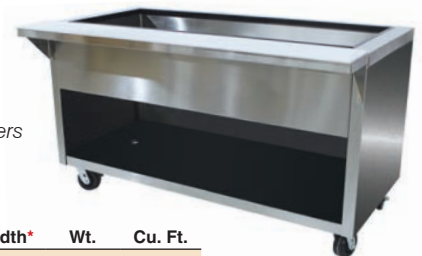

#### Enclosed Base

Model #	Price	Length	Width*	Wt.	Cu. Ft.
HDCPU-2-BS	<b>\$10401</b>	31-13/16"	36-1/4"	117 lbs.	27
HDCPU-3-BS	<b>12310</b>	47-1/8"	36-1/4"	145 lbs.	39
HDCPU-4-BS	<b>13310</b>	62-7/16"	36-1/4"	205 lbs.	58
HDCPU-5-BS	<b>16493</b>	77-3/4"	36-1/4"	250 lbs.	69
HDCPU-6-BS	<b>18057</b>	93-1/16"	36-1/4"	295 lbs.	81

#### With Doors

Model #	Price	Length	Width*	Wt.	Cu. Ft.
HDCPU-2-DR	<b>\$10740</b>	31-13/16"	36-1/4"	127 lbs.	27
HDCPU-3-DR	<b>12947</b>	47-1/8"	36-1/4"	155 lbs.	39
HDCPU-4-DR	<b>13706</b>	62-7/16"	36-1/4"	215 lbs.	58
HDCPU-5-DR	<b>17078</b>	77-3/4"	36-1/4"	264 lbs.	69
HDCPU-6-DR	<b>18788</b>	93-1/16"	36-1/4"	309 lbs.	81

\*Width Includes 8" Cutting Board

See Pages 137-140 For Shelving & Accessories!

# BUFFET TABLES

## Everyday Buffet Hot Food Tables

For Use with Optional Spillage Pans

- Stainless Steel Top And Body
- Matte Black Vinyl Clad
- 8" Deep Liners For Optional SP-A Or SP-S Spillage Pans
- 1/4" Thick, Double Sided Thermoplastic Polymer Sneeze Guard & Side Panels
- 4" Swivel Casters, Two With Brakes
- Fiberglass Insulation
- Pre-Drilled For Optional Solid Drop-Down Tray Shelf available for one or both sides

- Infinite Control Knobs
- Indicator Lights
- 8 Ft. Electric Cord w/ Plug Included
- Single Phase Wiring (Upgrade to 3 Phase Wiring for 240 Volt Units- **Model # SU-72 \$725**)
- To Omit Sneeze Guard use **Model # BSG-OMIT** deduct **\$417**



**Open Base**  
B3-120-B-S Shown

### Open Base

Galvanized Liners	Price	Stainless Steel Liners	Price	Length	# of Wells	NEMA Plug	Volts	Amps	Watts	Wt.	Cu. Ft.
B2-120-B	\$6330	B2-120-B-S	\$7095	31-13/16"	2	5-20P	120	8.33	1000	135 lbs.	39
B3-120-B	6944	B3-120-B-S	7439	47-1/8"	3	5-20P	120	12.50	1500	246 lbs.	56
B4-120-B	7862	B4-120-B-S	8592	62-7/16"	4	L5-30P	120	16.67	2000	301 lbs.	73
B2-240-B	6330	B2-240-B-S	7095	31-13/16"	2	6-20P	208/240	7.21/8.33	1500/2000	135 lbs.	39
B3-240-B	6722	B3-240-B-S	7439	47-1/8"	3	6-20P	208/240	10.82/12.50	2250/3000	170 lbs.	57
B4-240-B	7862	B4-240-B-S	8592	62-7/16"	4	L6-30P	208/240	14.42/16.67	3000/4000	310 lbs.	73
B5-240-B	9695	B5-240-B-S	10157	77-3/4"	5	L6-30P	208/240	18.03/20.84	3750/5000	343 lbs.	90

### Enclosed Base

Galvanized Liners	Price	Stainless Steel Liners	Price	Length	# of Wells	NEMA Plug	Volts	Amps	Watts	Wt.	Cu. Ft.
B2-120-B-SB	\$7902	B2-120-B-S-SB	\$8283	31-13/16"	2	5-20P	120	8.33	1000	135 lbs.	39
B3-120-B-SB	8747	B3-120-B-S-SB	9322	47-1/8"	3	5-20P	120	12.50	1500	170 lbs.	56
B4-120-B-SB	9591	B4-120-B-S-SB	10561	62-7/16"	4	L5-30P	120	16.67	2000	310 lbs.	73
B2-240-B-SB	7902	B2-240-B-S-SB	8283	31-13/16"	2	6-20P	208/240	7.21/8.33	1500/2000	135 lbs.	39
B3-240-B-SB	8747	B3-240-B-S-SB	9322	47-1/8"	3	6-20P	208/240	10.82/12.50	2250/3000	170 lbs.	56
B4-240-B-SB	9591	B4-240-B-S-SB	10561	62-7/16"	4	L6-30P	208/240	14.42/16.67	3000/4000	210 lbs.	73
B5-240-B-SB	11032	B5-240-B-S-SB	11891	77-3/4"	5	L6-30P	208/240	18.03/20.84	3750/5000	235 lbs.	90



**Enclosed Base**  
B3-120-B-SB Shown

## BUFFET TABLE SEALED WELL WITH ENCLOSED BASE

- Stainless Steel Top And Body
- Stainless Steel Sealed Wells with Manifold Drains
- Matte Black Vinyl Clad
- 10 Gauge Aluminum Dome Shape Heat Element
- 20 Gauge Stainless Steel Deep Drawn Bowls With 1" Drain
- 1/4" Thick, Double Sided Thermoplastic Polymer Sneeze Guard And Side Panels
- 4" Swivel Casters, Two With Brakes
- Fiberglass Insulation

- Optional Solid Drop-Down Tray Shelf available for one or both sides
- Infinite Control Knobs
- Indicator Lights
- Single Phase Wiring
- Single Phase Wiring (Upgrade to 3 Phase Wiring for 240 Volt Units- **Model # SU-72 \$725**)
- 8 Ft. Electric Cord w/ Plug Included
- To Omit Sneeze Guard use **Model # BSG-OMIT** deduct **\$397**



**Enclosed Base**  
BSW3-120-B-SB Shown

### Enclosed Base

Stainless Steel Liners	Price	Length	# of Wells	NEMA Plug	Volts	Amps	Watts	Wt.	Cu. Ft.
BSW2-120-B-SB	\$9400	31-13/16"	2	5-20P	120	10.67	1280	300 lbs.	30
BSW3-120-B-SB	10034	47-1/8"	3	5-20P	120	16	1920	325 lbs.	43
BSW4-120-B-SB	11315	62-7/16"	4	L5-30P	120	21.33	2560	356 lbs.	55
BSW2-240-B-SB	9400	31-13/16"	2	6-20P	208/240	7.94/9.16	1650/2200	300 lbs.	30
BSW3-240-B-SB	10034	47-1/8"	3	6-20P	208/240	11.91/13.74	2475/3300	325 lbs.	43
BSW4-240-B-SB	11315	62-7/16"	4	L6-30P	208/240	15.88/18.32	3300/4400	356 lbs.	55
BSW5-240-B-SB	13203	77-3/4"	5	L6-30P	208/240	19.85/22.90	4125/5500	370 lbs.	68

**NOTE: Units are not designed to cook or heat frozen or refrigerated foods. Food placed in tables should already be hot, and the table will maintain the proper temperatures**

### END SHELF FOR HOT/COLD TABLES

(Excludes HDSW, HDRCP & HDCPU Units)

- 10" Wide x 22 1/2" Length
- Stainless Steel

Stationary TES-1	Drop-Down TES-1D
\$1064	\$1255

See Pages 137-140 For Shelving & Accessories!



# BUFFET TABLES

## Everyday Buffet Ice-Cooled Tables

For Use with Optional Spillage Pans

- Stainless Steel Top And Body
- Matte Black Vinyl Clad
- 9" Deep Liners With Adapter Bars For Optional **SP-A** Or **SP-S** Spillage Pans
- 1/4" Thick, Double Sided Thermoplastic Polymer Sneeze Guard And Side Panels
- 4" Swivel Casters, Two With Brakes
- Fiberglass Insulation
- Pre-Drilled For Optional Solid Drop-Down Tray Shelf available for one or both sides
- To Omit Sneeze Guard use **Model # BSG-OMIT** deduct **\$417**

### Open Base

Model	Price	Length	# of Wells	Wt.	Cu. Ft.
B2-CPU-B	<b>\$5936</b>	31-13/16"	2	225 lbs.	53
B3-CPU-B	<b>6491</b>	47-1/8"	3	250 lbs.	76
B4-CPU-B	<b>7050</b>	62-7/16"	4	310 lbs.	97
B5-CPU-B	<b>8075</b>	77-3/4"	5	350 lbs.	119



**Open Base**  
B3-CPU-B Shown

### Enclosed Base

Model	Price	Length	# of Wells	Wt.	Cu. Ft.
B2-CPU-B-SB	<b>\$6702</b>	31-13/16"	2	235 lbs.	53
B3-CPU-B-SB	<b>6950</b>	47-1/8"	3	260 lbs.	76
B4-CPU-B-SB	<b>7598</b>	62-7/16"	4	320 lbs.	97
B5-CPU-B-SB	<b>8786</b>	77-3/4"	5	360 lbs.	119



**Enclosed Base**  
B3-CPU-B-SB Shown

**NOTE: Units are not designed to cool foods originally warm. Food should already be chilled to maintain the proper temperatures**

## Everyday Buffet Tables with Solid Top

- Stainless Steel Top And Body
- Solid Stainless Steel Top
- Matte Black Vinyl Clad
- 1/4" Thick, Double Sided Thermoplastic Polymer Sneeze Guard on top and side panels and Side Panels
- 4" Swivel Casters, Two With Brakes
- Optional Solid Drop-Down Tray Shelf available for one or both sides
- To Omit Sneeze Guard use **Model # BSG-OMIT** deduct **\$397**

### Open Base

Model	Price	Length	Wt.	Cu. Ft.
B2-STU-B	<b>\$6135</b>	31-13/16"	291 lbs.	59
B3-STU-B	<b>6561</b>	47-1/8"	336 lbs.	85
B4-STU-B	<b>7370</b>	62-7/16"	370 lbs.	109
B5-STU-B	<b>8429</b>	77-3/4"	414 lbs.	133



**Open Base**  
B3-STU-B Shown

### ENCLOSED BASE

Model	Price	Length	Wt.	Cu. Ft.
B2-STU-B-SB	<b>\$6523</b>	31-13/16"	302 lbs.	59
B3-STU-B-SB	<b>7367</b>	47-1/8"	347 lbs.	85
B4-STU-B-SB	<b>8215</b>	62-7/16"	381 lbs.	109
B5-STU-B-SB	<b>8677</b>	77-3/4"	426 lbs.	133



**Enclosed Base**  
B3-STU-B-SB Shown

**See Pages 137-140 For Shelving & Accessories!**

# BUFFET TABLES

## Mechanically Assisted Everyday Buffet Tables

For Use with Optional Spillage Pans



### COLD PAN TABLES WITH ENCLOSED BASE

- Stainless Steel Top, Liner And Body
- Self contained condensing unit provided with a hermetically sealed compressor with a digital, programmable thermostat
- Full Insulation With 22 Gauge Galvanized Outer Jacket
- Removable access door to compressor
- Fiberglass Insulation
- High Cooling Capacity
- Sight Glass To Ensure Properly Charges System
- Low Running Current
- Precision Thermostat For Exact Temperature Control
- 1" I.P.S. Drain

- 1/4" Thick, Double Sided Thermoplastic Polymer Sneeze Guard And Side Panels
- 4" Swivel Casters, Two With Brakes
- Includes Food Pan Adapters For optional 12" X 20" Pans
- Matte Black Vinyl Clad
- Pre-Drilled For Optional Solid Drop-Down Tray Shelf available for one or both sides
- Single Phase Wiring
- 8 Ft. Electric Cord w/ Plug Included
- To Omit Sneeze Guard use **Model # BSG-OMIT** deduct **\$397**



**Enclosed Base**  
BMACP3-B-SB Shown

Model	Price	Length	# of Wells	NEMA Plug	Refrigerant	Wt.	Cu. Ft.
BMACP2-B-SB	<b>\$15071</b>	31-13/16"	2	5-20P	R290	250 lbs.	30
BMACP3-B-SB	<b>16105</b>	47-1/8"	3	5-20P	R290	300 lbs.	43
BMACP4-B-SB	<b>16935</b>	62-7/16"	4	5-20P	R290	345 lbs.	55
BMACP5-B-SB	<b>18036</b>	77-3/4"	5	5-20P	R290	395 lbs.	68

**NOTE: Units are not designed to cook or heat frozen or refrigerated foods. Food placed in tables should already be hot, and the table will maintain the proper temperatures**

**SU-71** 5 Year Extended Parts Warranty on Refrigeration Unit **\$746 Per Unit**  
(Available for Refrigerated Tables & Drop-Ins. See Back Inside Cover For Full Details)



**CONNECT IT!**  
Prepare Tables To Be Locked Together While Keeping Them Lined Up!  
(One Charge For Each Table To Be Interlocked)  
**SU-19 \$831 per table**

**WARNING:** Refrigerated Equipment on this page may expose you to chemicals, including Ethanes, that are known to the State of California to cause cancer or birth defects or other reproductive harm. For more info, visit [www.p65warnings.ca.gov](http://www.p65warnings.ca.gov).

### PORTABLE CASH REGISTER STANDS WITH DRAWER & KEY LOCK

- 20 Gauge, 304 Stainless Steel Frame
- Locking Drawer
- 4" Swivel Casters With Two Brakes
- Open Storage Area
- Matte Black Vinyl Clad



Add Holes For Power Cord (Requires 2)  
**TA-108 \$174 per hole**



Model	Price	Length	Width	Height	Wt.	Cu. Ft.
BCRS-B	<b>\$3704</b>	22 1/2"	22 1/2"	34 3/8"	140 lbs.	19

### WITH LOCKING DOOR

- Stainless Steel Interior, Frame And Bottom
- Adjustable Hinges & Locking Door w/ Key
- Full Perimeter Bumpers
- Mid-Shelf
- Black Mica Finish On Door, Top & Sides
- Open Bottom Shelf For Glass Rack Storage
- 4" Swivel Casters With Two Brakes



Model	Price	Length	Width	Height	Wt.	Cu. Ft.
AMD-2B	<b>\$3356</b>	24.5"	23.5"	40.5"	160 lbs.	27

### EVERYDAY BUFFET SILVERWARE STAND

- 20 Gauge, 304 Stainless Steel Frame
- Includes 12 Plastic Silverware Cups
- 4" Swivel Casters With Two Brakes
- Matte Black Vinyl Clad



(Trays & silverware shown not included)

Model	Price	Length	Width	Height	Wt.	Cu. Ft.
BSWS-B	<b>\$4515</b>	31.875"	22.4"	40"	160 lbs.	28

### Food Table Modifications & Accessories

For Our Full Line Of Hot Food Table Modifications, Accessories & Replacement Parts, See Page 137-140

TCB-OMIT	Remove Poly Cutting Board	<b>-\$227 ea.</b>	SU-45A	12" x 1" Adapter Bar	<b>84 ea.</b>
CB-OMIT	Remove Poly Cutting Board Only	<b>-113 ea.</b>	SU-45B	20" x 3" Adapter Bar	<b>95 ea.</b>
SU-6	Hot/Cold Food Table Handle	<b>\$260 ea.</b>	SU-72	Upgrade 240 volt units to 3-Phase Wiring	<b>725 ea.</b>
SU-6-B	Everyday Buffet Handle	<b>\$260 ea.</b>	SP-A	Aluminum Spillage Pan	<b>192 ea.</b>
SU-6-HD	Heavy Duty Hot/Cold Food Table Handle	<b>\$260 ea.</b>	SP-S	Stainless Steel Spillage Pan	<b>337 ea.</b>
SU-19	Prepare Hot Tables To Be Locked Together (One Charge For Each Table To Be Interlocked)	<b>831 ea.</b>			



# ACCESSORIES

## Hot/Cold Food Table Shelving

### TRAY SHELVES

#### 10" Wide Stainless Steel Tray Shelves



STATIONARY			DROP-DOWN		
Model	Price		Model	Price	
TTS-2	\$1111		TTS-2D	\$1304	31-13/16" 15 lbs. 3
TTS-3	1314		TTS-3D	1516	47-1/8" 17 lbs. 4
TTS-4	1344		TTS-4D	1615	62-7/16" 19 lbs. 5
TTS-5	1613		TTS-5D	1803	77-3/4" 22 lbs. 6
TTS-6	1965		TTS-6D	2198	93-1/16" 25 lbs. 6

#### 12" Wide Stainless Steel Tray Rails



STATIONARY			DROP-DOWN		
Model	Price		Model	Price	
TTR-2	\$1009		TTR-2D	\$1179	31-13/16" 14 lbs. 3
TTR-3	1239		TTR-3D	1422	47-1/8" 16 lbs. 4
TTR-4	1392		TTR-4D	1525	62-7/16" 18 lbs. 5
TTR-5	1617		TTR-5D	1756	77-3/4" 21 lbs. 6
TTR-6	1973		TTR-6D	2141	93-1/16" 23 lbs. 6

### FOOD TABLE SHELVES

With Removable 3/8" Thick Poly Cutting Board

- All Stainless Steel Construction
- Cutting Board Attaches To Top Shelf Using Acorn Nuts



8" Wide	Price	10" Wide	Price	12" Wide	Price	Length	Approx Wt.	Cu. Ft.
TCB-2	\$481	TCB-2-10	\$528	TCB-2-12	\$634	31-13/16"	16 lbs.	3
TCB-3	651	TCB-3-10	716	TCB-3-12	859	47-1/8"	19 lbs.	4
TCB-4	817	TCB-4-10	898	TCB-4-12	1077	62-7/16"	23 lbs.	5
TCB-5	950	TCB-5-10	1046	TCB-5-12	1255	77-3/4"	26 lbs.	6
TCB-6	1115	TCB-6-10	1235	TCB-6-12	1482	93-1/16"	29 lbs.	7

TCB-OMIT Remove Poly Cutting Board & Shelf  
 CB-OMIT Remove Poly Cutting Board Only

-\$227 ea.  
 -\$113 ea.

#### Replacement 3/8" Poly Cutting Boards



Model	Price	Length	Approx Wt.
SU-P-342	\$254	31-13/16"	9 lbs.
SU-P-343	309	47-1/8"	11 lbs.
SU-P-344	347	62-7/16"	13 lbs.
SU-P-345	370	77-3/4"	15 lbs.
SU-P-346	424	93-1/16"	18 lbs.

### 7" WIDE DISH SHELVES

Connects To TCB Series Shelf

Includes 2 Side Panels & Lower Shelf



Poly Cutting Board & Top Shelf Not Included

Model	Price	Length	Approx Wt.	Cu. Ft.
TDS-2	\$882	31-13/16"	20 lbs.	3
TDS-3	1053	47-1/8"	27 lbs.	4
TDS-4	1392	62-3/8"	31 lbs.	5
TDS-5	1604	77-3/4"	38 lbs.	6
TDS-6	1809	93-1/16"	45 lbs.	7

### END SHELF FOR HOT/COLD TABLES

(Excludes HDRCP, HDSW & HDCPU Units)

- 10" Wide x 22 1/2" Length
- Stationary or Drop-Down
- All Stainless Steel Construction



STATIONARY		DROP-DOWN		Approx Wt.	Cu. Ft.
Model	Price	Model	Price		
TES-1	\$1064	TES-1D	\$1255	15 lbs.	3

### TABLE MOUNTED OVERSHELVES

- TOS Series: Upper Shelf Secures To Lower Shelf With Expander Hardware (Included)
- Shipped KD

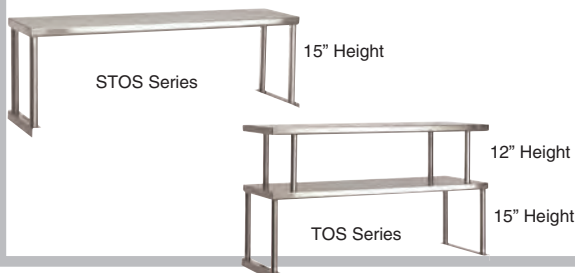

12" Wide			18" Wide		
Model	Price	Approx Wt.	Model	Price	Approx Wt.
<b>Single Tier</b>					
STOS-2	\$1268	18 lbs.	STOS-2-18	\$1613	20 lbs.
STOS-3	1441	21 lbs.	STOS-3-18	1736	23 lbs.
STOS-4	1621	24 lbs.	STOS-4-18	1880	26 lbs.
STOS-5	1756	27 lbs.	STOS-5-18	2052	30 lbs.
STOS-6	2141	33 lbs.	STOS-6-18	2502	35 lbs.
<b>Double Tier</b>					
TOS-2	2301	32 lbs.	TOS-2-18	2736	35 lbs.
TOS-3	2686	38 lbs.	TOS-3-18	3157	56 lbs.
TOS-4	3070	44 lbs.	TOS-4-18	3607	47 lbs.
TOS-5	3451	49 lbs.	TOS-5-18	4046	53 lbs.
TOS-6	4213	56 lbs.	TOS-6-18	4938	61 lbs.

# ACCESSORIES

## Hot/Cold Food Table Food Shields



Meets Latest NSF Standards

### Sleek Shields™

Protected By: Patent No. US 9,010,883 B2



FEATURING ADVANCE TABCO'S REVOLUTIONARY CHAMBER LOCK™ ROTATION SYSTEM

Front Glass Locks Into Place At 15° Intervals

For Double Sided Sleek Shields™  
On Everyday Buffets Please Consult Factory

### GLASS FOOD SHIELDS

Mounts To Top Of Hot/Cold Food Tables On Pgs. 127-135  
(Excluding Drop-In Wells)

- 18 3/4" Standard Height (Top of Table To Top)
- 15" Wide Glass Top or Stainless Steel Shelf  
NSG/NSGC Models: Shelves Have Square Edges On All Four Sides.  
GSG Models: Glass Top Features 3/8" Heat-Tempered Glass Top
- 1" Stainless Steel Tubing Posts
- Includes Two 18" Wide x 16 3/8" High Glass Side Panels
- 1/4" Thick Heat-Tempered Glass Front & Sides\*
- Ships KD



NSG-15-4WELL Shown

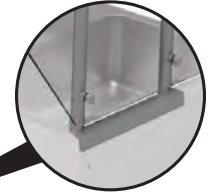

Includes TA-47  
Mounting Brackets  
For In-Field Installation

### Self-Serve - Single Side

15" Wide Stainless Steel Shelf			15" Wide w/ Glass Top			Fits # of Bowls	Approx. Wt.	Approx. Cubes
Model #	Price	O.A. Size L x W x H	Model #	Price	O.A. Size L x W x H			
NSG-15-2WELL	\$5067	31-13/16" x 19 3/4" x 18 3/4"	GSG-15-2WELL	\$6080	31 13/16" x 19 3/4" x 18"	Fits 2-Well Unit	109 lbs.	15
NSG-15-3WELL	5275	47-1/8" x 19 3/4" x 18 3/4"	GSG-15-3WELL	6308	47-1/8" x 19 3/4" x 18"	Fits 3-Well Unit	143 lbs.	22
NSG-15-4WELL*	6175	62 7/16" x 19 3/4" x 18 3/4"	GSG-15-4WELL*	6712	62 7/16" x 19 3/4" x 18"	Fits 4-Well Unit	186 lbs.	29
NSG-15-5WELL**	6744	77 3/4" x 19 3/4" x 18 3/4"	Not Available		Not Available	Fits 5-Well Unit	215 lbs.	38
NSG-15-6WELL**	7470	93 1/16" x 19 3/4" x 18 3/4"	Not Available		Not Available	Fits 6-Well Unit	247 lbs.	47

\*3/8" Thick Heat-Tempered Glass Required For Front Glass \*\*Requires a Single Center Post (Factory Print Included)

### Cafeteria Style - Single Side

15" Wide Stainless Steel Shelf			Fits # of Bowls	Approx. Wt.	Approx. Cubes
Model #	Price	O.A. Size L x W x H			
NSGC-15-2WELL	\$6078	31-13/16" x 19 3/4" x 18 3/4"	Fits 2-Well Unit	135 lbs.	15
NSGC-15-3WELL	6260	47-1/8" x 19 3/4" x 18 3/4"	Fits 3-Well Unit	176 lbs.	22
NSGC-15-4WELL*	6858	62 7/16" x 19 3/4" x 18 3/4"	Fits 4-Well Unit	232 lbs.	29
NSGC-15-5WELL**	7296	77 3/4" x 19 3/4" x 18 3/4"	Fits 5-Well Unit	265 lbs.	38
NSGC-15-6WELL**	8162	93 1/16" x 19 3/4" x 18 3/4"	Fits 6-Well Unit	300 lbs.	47

\*3/8" Thick Heat-Tempered Glass Required For Front Glass \*\*Requires a Center Leg (Factory Print Included)

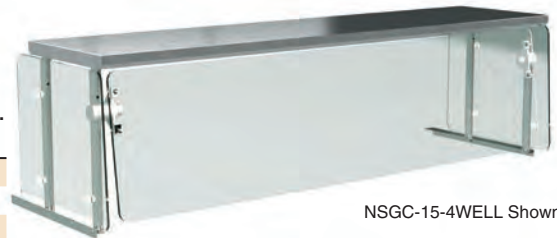

NSGC-15-4WELL Shown

For Sleek Shield™ Modifications, Accessories  
and Heat Lamps, See Page 73

Due to mounting requirements, food shields extend 15/16" beyond the end of the hot or cold table on each end. Units set side by side must allow for this additional space.

### Self-Serve - Double Sided

- 18 3/4" Standard Height (Top of Table To Top)
- 22 3/4" Wide Stainless Steel Shelf with Square Edges On All Four Sides.
- 1" Stainless Steel Tubing Posts
- Includes Two 16 3/8" High Glass Side Panels
- 1/4" Thick Heat-Tempered Glass Front & Sides
- Ships Set Up

25" Wide Stainless Steel Shelf			Fits # of Bowls	Approx. Wt.	Approx. Cubes
Model #	Price	O.A. Size L x W x H			
NSGD-26-2WELL	\$8628	31-13/16" x 19 3/4" x 18 3/4"	Fits 2-Well Unit	285 lbs.	20
NSGD-26-3WELL	8861	47-1/8" x 19 3/4" x 18 3/4"	Fits 3-Well Unit	340 lbs.	27
NSGD-26-4WELL*	9878	62 7/16" x 19 3/4" x 18 3/4"	Fits 4-Well Unit	425 lbs.	36
NSGD-26-5WELL**	10079	77 3/4" x 19 3/4" x 18 3/4"	Fits 5-Well Unit	515 lbs.	44
NSGD-26-6WELL**	10740	93 1/16" x 19 3/4" x 18 3/4"	Fits 6-Well Unit	605 lbs.	54

\*3/8" Thick Heat-Tempered Glass Required For Front Glass \*\*Requires a Single Center Post (Factory Print Included)



NSGD-26-4WELL Shown

Due to mounting requirements, food shields extend 15/16" beyond the end of the hot or cold table on each end. Units set side by side must allow for this additional space.

# ACCESSORIES

## Hot & Cold Table Accessories

### CAFETERIA SHELVES w/ BUILT-IN ACRYLIC FOOD SHIELDS

Features Removable Stainless Steel Shelf

#### Single Sided Cafeteria Style

- 15" High
- 1" Clearance From Table Top

Model	Price	Length	Approx Wt.	Cu. Ft.
TSS-2	<b>\$1578</b>	33-14/17"	17 lbs.	2
TSS-3	<b>1887</b>	49-1/8"	20 lbs.	3
TSS-4	<b>2057</b>	65-7/17"	23 lbs.	4
TSS-5	<b>2208</b>	81-3/4"	33 lbs.	4
TSS-6	<b>2639</b>	98-1/17"	33 lbs.	5



#### Double Sided Self-Serve Style

- 19-3/4" High
- 10" Clearance From Table Top

Model	Price	Length	Approx Wt.	Cu. Ft.
TBS-2	<b>\$2505</b>	31-13/16"	28 lbs.	2
TBS-3	<b>2586</b>	47-1/8"	33 lbs.	3
TBS-4	<b>2822</b>	62-7/16"	38 lbs.	4
TBS-5	<b>3232</b>	77-3/4"	45 lbs.	4
TBS-6	<b>3513</b>	93-1/16"	52 lbs.	5

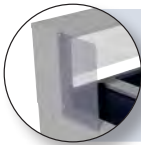

#### Acrylic Side Panel for TSS Series Shelves

Add Side Panels To Meet Additional NSF Requirements (1 Panel Per End)

Field Installation Available

TSP-1 **\$399 One End**  
TSP-2 **\$818 Two Ends**



#### Acrylic Side Panel for TBS Series Shelves

Add Side Panels To Meet Additional NSF Requirements (2 Panels Per End)

Field Installation Available

TBP-1 **\$481 One End**  
TBP-2 **\$959 Two Ends**

## LED Display Lighting

### For Everyday Buffets & Hot/Cold Table Shelving

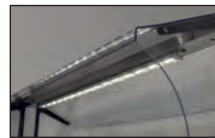

LED-B Series  
For Everyday Buffets



LED-H Series  
For Overshelves or Food Shields

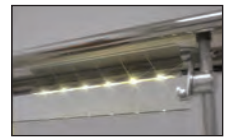

LED-G Series  
For GSG Series Food Shields

- Aluminum Rail with Shatter-Proof Optics
- Natural Aluminum Finish (Black or White Available On Request)
- Includes Class 2 Low Voltage Power Supply 120V-277V
- High Impact Resistant Mounting Clips

**NOTE:** Require 6" clearance on both sides to fit above LED Lighting. **PRINT REQUIRED FOR PROPER LED LOCATION. FACTORY INSTALLED ONLY**

Fits # of Wells	For use with Everyday Buffets		For use with STOS, TOS, TBS, TSS, NSG or NSGC Overshelves or Food Shields		For use with GSG Food Shields		LED Length
	Model #	Price	Model #	Price	Model #	Price	
2	LED-B-2	<b>\$2179</b>	LED-H-2	<b>\$2179</b>	LED-G-24	<b>\$991</b>	24"
3	LED-B-3	<b>2555</b>	LED-H-3	<b>2555</b>	LED-G-36	<b>1097</b>	36"
4	LED-B-4	<b>2934</b>	LED-H-4	<b>2934</b>	LED-G-48	<b>1196</b>	48"
5	LED-B-5	<b>3360</b>	LED-H-5	<b>3359</b>	Consult Factory		60"
6	Not Available		LED-H-6	<b>3801</b>	Consult Factory		72"

#### Individual Well Covers For Hot Food Tables

- Stainless Steel
- Removable
- Fits All Advance Tabco Hot Well Units



HFC-1 **\$527 Per Well**

#### Flip-Up Cover For Hot Food Tables

- Stainless Steel
- Removable
- Fits Advance Tabco Hot Well Units



Model #	Price	Fits # of		
		Comp.	Wt.	Cu.
RC-1	<b>\$1096</b>	1	23	5
RC-2	<b>1239</b>	2	60	10
RC-3	<b>1428</b>	3	74	15
RC-4*	<b>1991</b>	4	120	20
RC-5**	<b>2220</b>	5	134	25

\* Supplied with Two RC-2 Covers

\*\* Supplied with One RC-2 & One RC-3 Cover

#### Hinge Style Cover For Cold Food Tables

- Stainless Steel
- Plastic Handles & Piano Style Hinge(s)
- Fits CPU, DICP & MACP & BMAPC Units

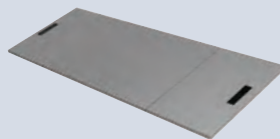

Model #	Price	Fits # of		
		Comp.	Wt.	Cu.
HC-2	<b>\$581</b>	2	12	3
HC-3	<b>868</b>	3	16	4
HC-4	<b>950</b>	4	20	5
HC-5	<b>1104</b>	5	24	6

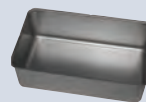

SP-A



TA-255P



SU-25S

#### Stainless Steel Legs & Undershelf Upgrade

2 Wells	3 Wells	4 Wells	5 Wells
SU-23A <b>\$1134</b>	SU-23B <b>\$1173</b>	SU-23C <b>\$1244</b>	SU-23D <b>\$1399</b>

SU-6	Hot/Cold Food Table Handle	<b>\$260 ea.</b>
SU-25S	Add Casters to Food Units w/Undershelf (Includes 4 - 5" Swivel Casters, 2 w/ Brakes & Legs that maintain height)	<b>678 Set of 4</b>
SU-25	Add Casters to Food Units w/Undershelf (For Units Built Before October 2015. Includes 4 - 5" Swivel Casters, 2 w/ Brakes.)	<b>624 Set of 4</b>
SU-19	Connect Cafeteria Items (One Charge For Each Table To Be Interlocked)	<b>831 per table</b>
TA-25	Replacement Casters For Undershelf Units (For Units Built after October 2015. Includes 4 - 5" Swivel Casters, 2 w/ Brakes.)	<b>624 Set of 4</b>
TA-255P	Add Casters to Enclosed Base Food Units (Includes 4 - 5" Bolted Swivel Casters, 2 w/ Brakes)	<b>981 Set of 4</b>
SU-32G	Upgrade to a Stainless Steel Lining (For Gas Units. Excludes Wetbath Units)	<b>176 per well</b>
SP-A	Aluminum Spillage Pan	<b>192 ea.</b>
SP-S	Stainless Steel Spillage Pan	<b>337 ea.</b>
TCB-OMIT	Remove Poly Cutting Board & Shelf	<b>-227 ea.</b>
CB-OMIT	Remove Poly Cutting Board	<b>-113 ea.</b>

# REPLACEMENT PARTS

## Replacement Parts For Hot Food Tables

 All Items on This Page Ship via UPS

### FOR GAS HOT FOOD TABLES



#### Gas Valve

Hi/Med/Lo

SU-P-101 **\$117**



#### Valve Adapter

SU-P-104 **\$68**



#### Gas Pilot Valve

SU-P-108 **\$85**



#### Gas Regulator

SU-P-109 **\$160**



#### Jet Burners

SU-P-105 **\$182**

NAT 5/16 #61

SU-P-106 **\$182**

LP 5/16 #74



#### Gas Pilot

For Wet Bath Units

SU-P-107 **\$280**

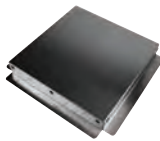

#### Gas Deflector

SU-P-411 **\$49**

Standard HFxG Units

SU-P-412 **\$72**

Stainless For SU-32G Wells



#### Pilot Assembly

HF-xG

SU-P-102 **\$131**



#### Gas Infinite Control Knob

SU-P-202 **\$66**



#### 1 1/2" Drain

Stainless Steel

For Wetbath Tables

SU-P-103 **\$95**

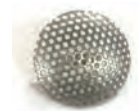

#### Strainer Screen

For Sealed Well Tables

SU-P-403 **\$30**

### FOR ELECTRIC HOT FOOD TABLES

#### ELECTRIC HEATING ELEMENTS

##### For Exposed Element (Dry) Models

SU-P-207 **\$182**

500W 120V

SU-P-204 **\$182**

1000W 240V



##### For Concealed Element Sealed Well (Wet) Models

SU-P-209 **\$207**

640W 120V

SU-P-206 **\$207**

1100W 240V

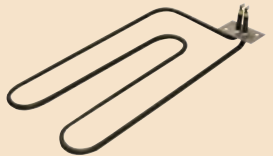

SU-P-210 **\$207**

1100W 120V - For Drop-In Units Only

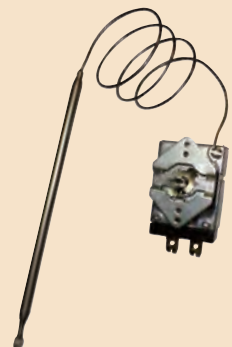

#### Thermostatic Control

##### Replacement Thermostatic Control

SU-P-220A **\$328 Per Well**

120v/240v, 24" lead For Free-Standing Sealed Well Hot Food Units

SU-P-220B **\$328 Per Well**

120v/240v, 72" lead For Drop-In Sealed Well Hot Food Units



#### Electric Infinite Control Knob

SU-P-201 **\$66**



#### Thermostatic Knob

(For Units with Thermostatic Control)

SU-P-219 **\$71**



#### Replacement Sealed Well Sub-Assembly

SU-P-401 **\$1117**

Without Element or High Limit Switch



SU-P-402 **\$65**

Sealed Well or Element Pan Only

#### NEMA Plugs

8' Cord Set



SU-P-230 **\$151**

NEMA 5-20P



SU-P-231 **\$420**

NEMA L5-30P

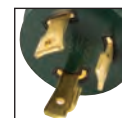

SU-P-232 **\$151**

NEMA 6-20P

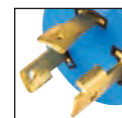

SU-P-233 **\$420**

NEMA L6-30P



SU-P-234 **\$234**

NEMA 5-15



#### Infinite Control

SU-P-205 **\$159**

120V

SU-P-215 **\$159**

240V



#### Indicator Lights

SU-P-216 **\$114**

120V

SU-P-217 **\$114**

240V



#### High Limit Switch Assembly

SU-P-208 **\$245**

347F

# ALUMINUM RACKS

## Aluminum Pan Racks



### FRONT LOAD



### SIDE LOAD



## K.D. PAN RACKS

- 6 Cylindrical Support Bars
- 1" Square Tubing
- 5" Poly Stem Bolted Casters
- 1 1/2" Ribbed Angles
- Shipped K.D.
- Easy To Assemble

Model #	Price	Description	Pan Capacity	Shelf Spacing	Overall Size	Approx. Wt.
PR10-3K	<b>\$891</b>	Front Load	10 Full or 20 Half Size	3"	20 1/4" x 26" x 38 1/4"	14 lbs.
PR12-5K	<b>938</b>	Front Load	12 Full or 24 Half Size	5"	20 1/4" x 26" x 69 1/4"	24 lbs.
PR18-3K	<b>1119</b>	Front Load	18 Full or 36 Half Size	3"	20 1/4" x 26" x 63 1/4"	31 lbs.
PR20-3K	<b>1058</b>	Front Load	20 Full or 40 Half Size	3"	20 1/4" x 26" x 69 1/4"	33 lbs.
PR30-2K	<b>1134</b>	Front Load	30 Full Size	2"	20 1/4" x 26" x 69 1/4"	39 lbs.
PR18-3KS	<b>1052</b>	Side Load	18 Full Size	3"	26 1/4" x 18" x 63 1/4"	31 lbs.
PR20-3KS	<b>1104</b>	Side Load	20 Full Size	3"	26 1/4" x 18" x 69 1/4"	27 lbs.

SEE PAGE 146  
FOR  
PROPER  
REPLACEMENT  
CASTERS



## ALL WELDED - CURVED TOP - STANDARD



### SIDE LOAD



- Heavy Duty Welded Construction
- 1" Square Tubing
- Curved Top
- 5" Poly Stem Bolted Casters
- 6 Cross Supports
- 1 1/2" Heavy Duty Ribbed Angles

Model #	Price	Description	Pan Capacity	Shelf Spacing	Overall Size	Approx. Wt.
PR10-3W	<b>\$1055</b>	Front Load	10 Full or 20 Half Size	3"	20 1/4" x 26" x 38 1/2"	25 lbs.
PR10-6W	<b>1220</b>	Front Load	10 Full or 20 Half Size	6"	20 1/4" x 26" x 69 1/4"	27 lbs.
PR12-5W	<b>1242</b>	Front Load	12 Full or 24 Half Size	5"	20 1/4" x 26" x 69 1/4"	28 lbs.
PR15-4W	<b>1258</b>	Front Load	15 Full or 30 Half Size	4"	20 1/4" x 26" x 69 1/4"	31 lbs.
PR18-3W	<b>1280</b>	Front Load	18 Full or 36 Half Size	3"	20 1/4" x 26" x 63 1/4"	34 lbs.
PR20-3W	<b>1294</b>	Front Load	20 Full or 40 Half Size	3"	20 1/4" x 26" x 69 1/4"	35 lbs.
PR30-2W	<b>1516</b>	Front Load	30 Full or 60 Half Size	2"	20 1/4" x 26" x 69 1/4"	43 lbs.
PR10-6WS	<b>1384</b>	Side Load	10 Full Size	6"	28 1/4" x 18" x 69 1/4"	26 lbs.
PR12-5WS	<b>1401</b>	Side Load	12 Full Size	5"	28 1/4" x 18" x 69 1/4"	27 lbs.
PR15-4WS	<b>1550</b>	Side Load	15 Full Size	4"	28 1/4" x 18" x 69 1/4"	30 lbs.
PR18-3WS	<b>1587</b>	Side Load	18 Full Size	3"	28 1/4" x 18" x 63 1/4"	27 lbs.
PR20-3WS	<b>1603</b>	Side Load	20 Full Size	3"	28 1/4" x 18" x 69 1/4"	34 lbs.

# ALUMINUM RACKS

## Specialty Racks

### ENCLOSED PAN CABINETS

- 14 Ga. Aluminum, Heavy Duty Welded Construction
  - Enclosed Extrusions
  - 5" Poly Plate Casters, 2 With Brakes
  - Flip Style Door Latch Handle
  - Side Door Lock to Prevent Opened Door From Swinging
  - 37 Pan Capacity
  - Optional Bumpers Available
  - Optional Pull Handle For Improved Mobility.
- Does Not Interfere With Other Side By Side Units.



Model #	Price	Description	Pan Capacity	Shelf Spacing	Overall Size	Approx. Wt.
EPC-40	\$3557	Front Load	37 Full or 74 Half Size	1 1/2"	20 1/2" x 27 1/2" x 66 1/4"	110 lbs.

### Optional Accessories

Model #	Description	Price
RA-21	Optional Pull Handle .....	\$515
RA-22	Full Perimeter Bumpers .....	359
RA-23	Corner Bumpers .....	287

### FULL & HALF SIZE CAN RACKS

Aluminum Top    Poly Top    Stainless Steel Top



Half Can Rack



Full Can Rack



Heavy Duty

Full Can Rack With Casters

### SPEC-LINE



- Heavy Duty Welded Construction
- Metal Bullet Feet on CR10-162 only
- 4" Plate Casters with two Brakes. Standard on all Can Racks EXCEPT CR10-162 (See CR10-162M).

Model #	Price	Description	Can Capacity		Overall Size	Approx. Wt.
			#10	#5		
CR10-162	\$2426	Full Can Rack	162	216	24 3/4" x 35 1/8" x 69 3/4"	65 lbs.
CR10-162M	2999	Full Can Rack (with Casters)	162	216	24 3/4" x 35 1/8" x 69 3/4"	76 lbs.
CR10-72	2349	Aluminum Top	72	96	24 3/4" x 35 1/8" x 40 1/8"	59 lbs.
CR10-54	2067	Aluminum Top	54	72	24 3/4" x 35 1/8" x 32 5/8"	54 lbs.
CRPL10-72	2590	Poly Top	72	96	24 3/4" x 35 1/8" x 40 1/8"	79 lbs.
CRPL10-54	2251	Poly Top	54	72	24 3/4" x 35 1/8" x 32 5/8"	74 lbs.
CRSS10-72	2471	Stainless Steel Top	72	96	24 3/4" x 35 1/8" x 40 1/8"	63 lbs.
CRSS10-54	2439	Stainless Steel Top	54	72	24 3/4" x 35 1/8" x 32 5/8"	55 lbs.

# ALUMINUM RACKS

## Aluminum Pan Racks



Front Load

### SPEC-LINE OVEN RACKS

Featuring High Temp Oven Plate Casters and All Welded Curved Top



- Heavy Duty Welded Construction
- 1" Square Tubing
- Curved Top
- 6 Cross Supports
- 4" Oven Plate Casters
- 1 1/2" Ribbed Angles

Model #	Price	Description	Pan Capacity	Shelf Spacing	Overall Size	Approx. Wt.
CFL20	\$2125	Front Load	20 Full or 40 Half Size	3"	20 1/4" x 26" x 68 5/8"	45 lbs.

### Optional Accessories



Model #	Description	Price
RA-10	Pan Stop.....	\$335
RA-20	Track Pin.....	260
ORL-B	Oven Lift .....	404

(For Front Load Pan Racks)

### REACH-IN RACKS

- All Welded Construction
- 1" Square Tubing
- Holds up to 16 Full or 32 Half Size Pans
- 3" Shelf Spacing
- 1" Front and Rear Cross Bracing
- Shipped KD



Model #	Price	Pan Capacity	Shelf Spacing	Approx. Wt.
RR-16	\$1109	16 Full or 32 Half Size	3"	23 lbs.

Consult Factory For All Welded Reach-In Racks

### BUS BOX RACK

- Heavy Duty Welded Construction
- Curved Top
- 5" Stem Bolted Casters
- Overall Size: 20 3/8" x 19" x 40 7/8"



Model #	Price	Bus Box Capacity	Approx. Wt.
BC3	\$873	3	18 lbs.

See Page 150  
For Aluminum Bun Pans



# SPECIALTY RACKS

## Specialty Racks

### PIZZA PAN & DOUGH RACKS

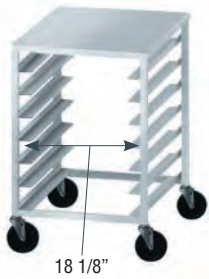

#### PDB7

- All Welded Construction
- Solid Aluminum Top
- 7 Box Capacity
- 3 3/4" Shelf Spacing
- 5" Poly Stem Bolted Casters
- 2" Wide Slides

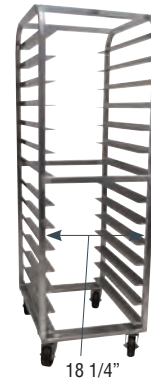

#### PDB14

- All Welded Construction
- No Top
- 14 Box Capacity
- 3 3/4" Shelf Spacing
- 4" Plate Casters
- 2" Wide Slides

Model #	Price	Description	Overall Size	Approx. Wt.
PDB7	\$1904	Pizza Dough Box Rack (With Top)	20 5/8" x 26 7/8 x 35"	33 lbs.

Model #	Price	Description	Overall Size	Approx. Wt.
PDB14	\$2760	Pizza Dough Box Rack (No Top)	26" x 20 1/4" x 61 1/2"	63 lbs.

PR10-3WT Shown



### HALF SIZE RACKS

- All Welded Construction
- 5" Poly Stem Bolted Casters
- 1-1/2" Ribbed Angles

#### PR7-4KT SERIES

- Removable Aluminum Top

PR7-4KT Shown



Model #	Price	Top	Description	Pan Capacity	Shelf Spacing	Overall Size	Approx. Wt.
PR7-4KT	\$1571	Aluminum Top	Front Load	7 Full/14 Half Size	3 3/4"	20 5/8" x 26 7/8 x 35"	28 lbs.
PR10-3WT	1640	Aluminum Top	Front Load	10 Full/20 Half Size	3"	20 1/4" x 26" x 38 1/2"	30 lbs.
PR10-3PT	1809	Poly Top	Front Load	10 Full/20 Half Size	3"	20 1/4" x 26" x 39"	45 lbs.
PR10-3ST	2133	Stainless Steel Top	Front Load	10 Full/20 Half Size	3"	20 1/4" x 26" x 39"	35 lbs.

\*Top shelf spacing on the PR7-4KT is 2-1/8"

### KEG RACKS

- 76" High, Aluminum Alloy Construction
- Shelves Are 1-3/4" Square Tubing
- 60 Lbs. Per Sq. Ft. Load Capacity Per Shelf
- Center Support Included On 93" Keg Shelves



#### Keg Rack Rear Strap

Prevents Kegs From Sliding Off Rear Of Keg Rack Shelf



Model #	Price	Size	# of Kegs (Per Unit)	Approx. Wt.
KR-42	\$1912	20" x 42"	4	50 lbs.
KR-60	2037	20" x 60"	6	68 lbs.
KR-72	2153	20" x 72"	8	80 lbs.
KR-80	2240	20" x 80"	8	88 lbs.
KR-93	2771	20" x 93"	10	100 lbs.

Model #	Price	Approx. Wt.
KR-1-42	\$224	6 lbs.
KR-1-60	249	7 lbs.
KR-1-72	251	8 lbs.
KR-1-80	278	9 lbs.
KR-1-93	302	10 lbs.

# ALUMINUM RACKS

## Specialty Racks

### SPECIAL PURPOSE RACKS

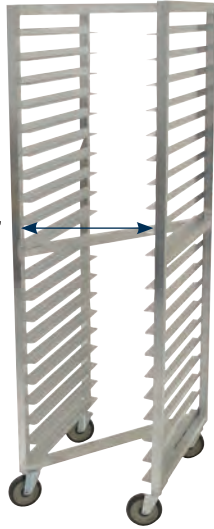

#### Nesting Pan Rack

**SPACESAVING DESIGN**

- Nested Design To Facilitate Maximum Storage In Minimum Space
- Heavy Duty Welded Construction With "Diagonal" Cross Supports
- 1 1/4" Square Tubing
- 1" X 1-1/2" Ribbed Angles
- Heavy Duty Stem Casters
- 500 Lb. Capacity

18 1/4"

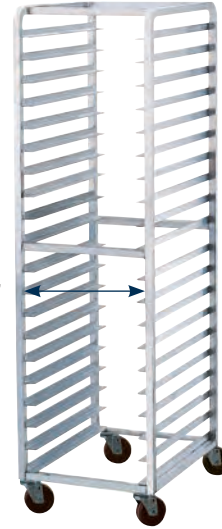

#### Steam Table Pan Rack

- Heavy Duty Welded Construction
- 1" Square Tubing
- Curved Top
- 6 Cross Supports
- 5" Poly Stem Bolted Casters

14 1/2"



Model #	Price	Pan Capacity	Shelf Spacing	Overall Size	Approx. Wt.
NR-20	1885	20 Full or 40 Half Size	3"	21" x 26" x 69 1/4"	29 lbs.

Model #	Price	Pan Capacity	Shelf Spacing	Overall Size	Approx. Wt.
STR20-3W	\$1831	20 Full or 40 Half Size	3"	16 3/4" x 21 1/4" x 69 1/4"	34 lbs.

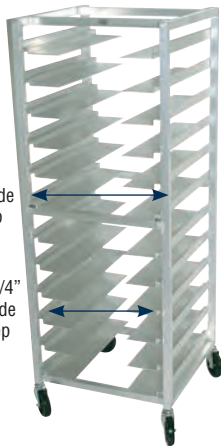

#### UNIVERSAL RACKS

- Heavy Duty Welded Construction
- 1-1/4" Square Tubing
- 6 Cross Supports
- Heavy Duty 5" Stem Bolted Casters
- Stepped Angles
- Overall Size: 26" x 26" x 69 1/4"
- Front Tray Load

23" Outside Step

20 3/4" Inside Step

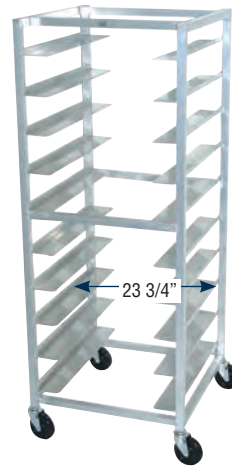

#### TRAY RACKS

Holds Baking Pans, Steam Table Pans & Service Trays

- Heavy Duty Welded Construction
- 1-1/4" Square Tubing
- Heavy Duty 5" Poly Stem Bolted Casters
- 4" Wide Angles
- Overall Size: 26" x 28" x 69 1/4"
- Front Tray Load

23 3/4"

Model #	Price	Pan Capacity	Shelf Spacing	Approx. Wt.
UR10	\$2478	10 Full or 20 Half Size	6"	86 lbs.
UR12	2562	12 Full or 24 Half Size	5"	100 lbs.

Model #	Price	Pan Capacity	Shelf Spacing	Approx. Wt.
OT20-3	2393	20 Full or 40 Half Size	3"	102 lbs.



#### LUG CARTS

- Heavy Duty Welded Construction
- 1" Square Tubing
- Curved Top
- 5" Stem Bolted Casters

Model #	Price	Lug Capacity	Overall Size L x W x H	Approx. Wt.
LR2	\$942	2	19" x 26" x 31 3/4"	18 lbs.
LR4	\$956	4	19" x 26" x 52 3/4"	21 lbs.
LR6	\$1063	6	19" x 26" x 69 3/4"	23 lbs.

# BUN PANS

## Bun Pans & Accessories



Look For Our Advertisized  
Specials on Sheet  
Pan Pricing

## ALUMINUM BUN PANS

 = All Bun Pans Ship via UPS

Model #	Price	Size	Style	Gauge	Approx. Wt.
18-A-26	<b>\$65 ea.</b>	18" x 26"	Heavy Duty	16	48 lbs.
18-8A-26	<b>56 ea.</b>	18" x 26"	Standard	18	40 lbs.
18-8P-26	<b>76 ea.</b>	18" x 26"	Perforated	18	33 lbs.
18-8A-13	<b>46 ea.</b>	18" x 13"	Half Size	18	24 lbs.

**Packed One Dozen per Carton.  
No splitting of CARTONS permitted.**

## PAN RACK ACCESSORIES

All Pan Rack Accessories Ship via UPS



12" Tall  
Vertical  
Bumper

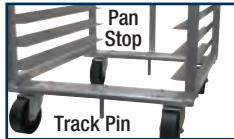

Pan  
Stop

Track Pin



Oven Lift for Front Load  
Pan Rack



Stem Bolted  
Caster



Hi-temp  
Oven  
Plate  
Caster



Plate  
Caster



Bun Pan  
Dolly  
Caster



PRC-1



PRC-2

### Bun Pan Rack Covers with 3 Zippers

PRC-1 Enclosed Heavy Duty Plastic Cover.....**\$457 ea.**  
with Clear Front

PRC-2 Economy See-Thru Plastic Cover..... **337 ea.**

**For Full Line of Aluminum Pan Racks,  
See Page 145-149**

Model #	Description	Weight Capacity	Approx. Weight	Price
RA-10	Pan Stop	-	3 lbs.	<b>\$335</b>
RA-20	Track Pin	-	3 lbs.	<b>260</b>
RA-24	12" Vertical Bumpers (Set of 4)	-		<b>223</b>
RA-25	5" Stem Bolted Caster	125 lbs.	4 lbs.	<b>82 ea.</b>
RA-26	5" Stem Bolted Caster w/ Brake	125 lbs.	4 lbs.	<b>97 ea.</b>
RA-25SV	5" Stem Bolted Caster for PR1803K, PR20-3K   & PR12-5K ONLY	125 lbs.	4 lbs.	<b>82 ea.</b>
RA-26SV	5" Stem Bolted Caster w/Brake for PR1803K, PR20-3K & PR12-5K ONLY	125 lbs.	4 lbs.	<b>97 ea.</b>
RA-30	4" Plate Caster w/ Built-in Zerk Grease Fitting	400 lbs.	4 lbs.	<b>278 ea.</b>
RA-35	4" Plate Caster w/ Brake	400 lbs.	4 lbs.	<b>291 ea.</b>
RA-40	4" Hi-temp Oven Plate Casters w/ Built-in Zerk Grease Fitting	300 lbs.	4 lbs.	<b>197 ea.</b>
RA-45	4" Hi-Temp Oven Plate Caster w/ Brake	300 lbs.	4 lbs.	<b>216 ea.</b>
RA-50	3" Bun Pan Dolly Caster	250 lbs.		<b>89 ea.</b>
RA-60	5" Heavy Duty Stem Caster for Universal & Oval Racks Only.	300 lbs.	4 lbs.	<b>129 ea.</b>
RA-65	5" Heavy Duty Stem Caster with Brake for Universal & Oval Racks Only.	300 lbs.	4 lbs.	<b>143 ea.</b>
ORL-B	18" Oven Lift For Front Load Pan Racks	-	1 lbs.	<b>404 ea.</b>

# RACKS & CARTS

Racks & Carts

## PAN TRUCK

- Heavy Duty Welded Construction
- 1" Square Tubing
- Curved Top
- Heavy Duty 3" Plate Casters
- Holds 60 Full Size Pans
- 600 lb. Weight Capacity



Model #	Price	Size	Approx. Wt.
PD-1	<b>\$739</b>	20" x 26 1/2" x 32"	20 lbs.

## UTILITY CARTS

- 2 Chrome Plated Numbered Posts
- 3 Adjustable Stainless Steel Shelves with Tapered Split Sleeves
- 4 Swivel Casters (2 w/Brakes) & Donut Bumpers
- 150 lb. Load Capacity
- Shipped Knocked Down



Model #	Price	Size	Shelf Size	Approx. Wt.
UC-3-1827	<b>\$2090</b>	31 3/4" x 18" x 38 1/4"	18" x 27"	25 lbs.
UC-3-2433	<b>\$2727</b>	37 3/4" x 24" x 38 1/4"	24" x 33"	40 lbs.

## GLASS RACK & PAN RACK DOLLIES

### Bun Pan Dolly



- Heavy Duty Welded Construction
- 3" Plate Casters
- Holds 60 Full Size Pans
- 600 lb. Weight Capacity



### Glass Rack Dolly

- Heavy Duty Welded Construction
- 3" Plate Casters
- 600 lb. Weight Capacity



Model #	Price	Description	Size	Approx. Wt.
 BPD-1	<b>\$796</b>	Bun Pan Dolly	26 3/4" x 18 3/4" x 5"	15 lbs.
 GRD-1	<b>691</b>	Glass Rack Dolly	20 1/2" x 20 1/2" x 5 1/4"	14 lbs.

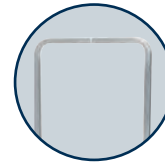

**Optional**  
Glass Rack Dolly Handle  
(Assembly Required)  
**RA-14 \$670**

## ALUMINUM DUNNAGE RACKS

### Stationary Dunnage Racks

8" & 12" Height Available



12" Height		8" Height		Size	# of Legs	Distribution Weight Capacity	Approx. Wt.
Model #	Price	Model #	Price				
DUN-2036	<b>\$420</b>	DUN-2036-8	<b>\$420</b>	20" x 36"	4	1500 lbs.	10 lbs.
DUN-2048	<b>486</b>	DUN-2048-8	<b>486</b>	20" x 48"	4	1800 lbs.	12 lbs.
DUN-2060	<b>552</b>	DUN-2060-8	<b>552</b>	20" x 60"	6	2000 lbs.	16 lbs.
DUN-2436	<b>475</b>	DUN-2436-8	<b>475</b>	24" x 36"	4	1500 lbs.	11 lbs.
DUN-2448	<b>552</b>	DUN-2448-8	<b>552</b>	24" x 48"	4	1800 lbs.	13 lbs.
DUN-2460	<b>616</b>	DUN-2460-8	<b>616</b>	24" x 60"	6	2000 lbs.	17 lbs.

### Mobile Dunnage Racks

- Four 6" Plate Casters (2 Swivel, 2 Stationary)
- Includes Pull Handle For Easier Mobility
- 2000 Lb. Rolling Capacity



**Now Includes Pull Handle**

### 36" Height with Handle

Model #	Price	Size	Distribution Weight Capacity	Approx. Wt.
DUN-2036C	<b>\$1122</b>	20" x 36"	1500 lbs.	35 lbs.
DUN-2048C	<b>1238</b>	20" x 48"	1800 lbs.	40 lbs.
DUN-2060C	<b>1442</b>	20" x 60"	2000 lbs.	45 lbs.

# SHELVING

## Chrome & Green Epoxy Wire Shelving

All Items on This Page Ships via UPS

WIRE SHELVES 

Each Shelf Holds Up To 800 Lbs. Distributed Weight

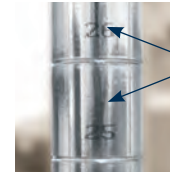
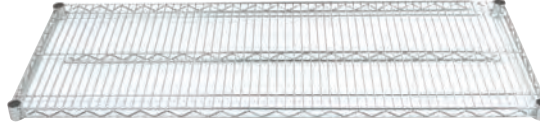

Posts are Numbered for easy assembly

	Shelf Size	CHROME	GREEN EPOXY	Price (Each)	Price (Set of 4)	Approx. Boxed Wt.	Approx. Boxed Cu. Ft.
<b>14" WIDE</b>	14" x 24"	EC-1424	EG-1424	\$95	\$380	35 lbs.	1.5
	14" x 30"	EC-1430	EG-1430	99	396	41 lbs.	2
	14" x 36"	EC-1436	EG-1436	105	420	47 lbs.	2.5
	14" x 42"	EC-1442	EG-1442	116	464	52 lbs.	3
	14" x 48"	EC-1448	EG-1448	127	508	58 lbs.	3.5
	14" x 60"	EC-1460	EG-1460	141	564	38 lbs.	2
	14" x 72"	EC-1472	EG-1472	189	756	45 lbs.	2.5
<b>18" WIDE</b>	18" x 24"	EC-1824	EG-1824	104	416	39 lbs.	2
	18" x 30"	EC-1830	EG-1830	106	424	45 lbs.	2.5
	18" x 36"	EC-1836	EG-1836	116	464	51 lbs.	3
	18" x 42"	EC-1842	EG-1842	137	548	56 lbs.	3.5
	18" x 48"	EC-1848	EG-1848	141	564	64 lbs.	4
	18" x 54"	EC-1854	EG-1854	180	720	35 lbs.	2
	18" x 60"	EC-1860	EG-1860	185	740	41 lbs.	2.5
<b>21" WIDE</b>	21" x 24"	EC-2124	EG-2124	110	440	42 lbs.	2.5
	21" x 30"	EC-2130	EG-2130	127	508	49 lbs.	3
	21" x 36"	EC-2136	EG-2136	138	552	56 lbs.	3.5
	21" x 42"	EC-2142	EG-2142	161	644	62 lbs.	4
	21" x 48"	EC-2148	EG-2148	172	688	70 lbs.	4.5
	21" x 54"	EC-2154	EG-2154	186	744	39 lbs.	2.5
	21" x 60"	EC-2160	EG-2160	208	832	45 lbs.	3
<b>24" WIDE</b>	24" x 24"	EC-2424	EG-2424	126	504	44 lbs.	3
	24" x 30"	EC-2430	EG-2430	141	564	51 lbs.	3.5
	24" x 36"	EC-2436	EG-2436	158	632	58 lbs.	4
	24" x 42"	EC-2442	EG-2442	172	688	64 lbs.	5
	24" x 48"	EC-2448	EG-2448	185	740	72 lbs.	5.5
	24" x 54"	EC-2454	EG-2454	216	864	41 lbs.	3
	24" x 60"	EC-2460	EG-2460	226	904	47 lbs.	3.5
	24" x 72"	EC-2472	EG-2472	257	1028	55 lbs.	4

24" To 48" Length Shelves Are Packed 4 To A Box And 54", 60" And 72" Shelves Are Packed 2 To A Box.  
4 Pair Plastic Split Sleeves Are Included With Each Shelf.

## POSTS FOR WIRE SHELVING

Posts Are Numbered

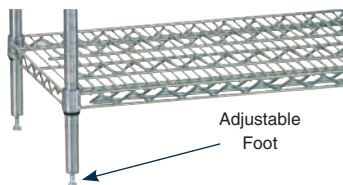

Post Height	Posts With Adjustable Foot				Posts For Casters (Casters Priced Separately)				Approx. Boxed Wt.	Approx. Cu. Ft.
	CHROME	GREEN EPOXY	Each	Set of 4	CHROME	GREEN EPOXY	Each	Set of 4		
14"	ECP-14	EGP-14	\$43	\$164	ECPC-14	EGPC-14	\$44	\$168	4 lbs.	.07
34"	ECP-34	EGP-34	57	216	ECPC-34	EGPC-34	57	216	8 lbs.	.18
54"	ECP-54	EGP-54	62	236	ECPC-54	EGPC-54	64	244	12 lbs.	.28
64"	ECP-64	EGP-64	67	256	ECPC-64	EGPC-64	72	276	15 lbs.	.33
74"	ECP-74	EGP-74	79	300	ECPC-74	EGPC-74	79	300	17 lbs.	.39
86"	ECP-86	EGP-86	95	360	ECPC-86	EGPC-86	95	360	20 lbs.	.45

### 5" CASTERS

Sets Feature 4 - 5" Swivel Casters (2 w/ Brakes & 4 Donut Bumpers)

Casters For Wire Shelving Only, See **Page 71** For Casters For Tables.

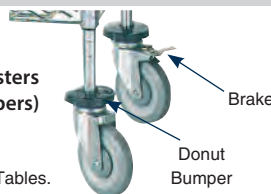

1000 lb. Max. Load Capacity For Shelving Casters

EC-25 Rubber Casters.....\$413 /set of 4

EC-26 Poly Casters..... 508 /set of 4

All Items on This Page Ships via UPS

# SHELVING

## Shelving Combos

### CHROME & GREEN EPOXY WIRE SHELVING COMBOS



Includes 4 Wire Shelves And 4 - 74" Posts



Chrome



Green Epoxy

Chrome		Green Epoxy		Shelf Size	Post Height	Approx. Wt.
Model #	Model #	Price	Price			
ECC-1436	EGG-1436	136		14" x 36"	74"	64 lbs.
ECC-1442	EGG-1442	780		14" x 42"	74"	69 lbs.
ECC-1448	EGG-1448	824		14" x 48"	74"	75 lbs.
ECC-1460	EGG-1460	880		14" x 60"	74"	93 lbs.
ECC-1472	EGG-1472	1072		14" x 72"	74"	107 lbs.
ECC-1836	EGG-1836	780		18" x 36"	74"	68 lbs.
ECC-1842	EGG-1842	864		18" x 42"	74"	73 lbs.
ECC-1848	EGG-1848	880		18" x 48"	74"	81 lbs.
ECC-1854	EGG-1854	1030		18" x 54"	74"	88 lbs.
ECC-1860	EGG-1860	1056		18" x 60"	74"	99 lbs.
ECC-1872	EGG-1872	1180		18" x 72"	74"	115 lbs.
ECC-2436	EGG-2436	948		24" x 36"	74"	75 lbs.
ECC-2442	EGG-2442	1003		24" x 42"	74"	81 lbs.
ECC-2448	EGG-2448	1056		24" x 48"	74"	89 lbs.
ECC-2454	EGG-2454	1180		24" x 54"	74"	97 lbs.
ECC-2460	EGG-2460	1160		24" x 60"	74"	111 lbs.
ECC-2472	EGG-2472	1280		24" x 72"	74"	127 lbs.

### MOBILE CARTS

Includes 4 Chrome Wire Shelves  
And 4 - 64" Posts

- 4 Swivel Casters  
(2 with Brakes & 4 Donut Bumpers)
- Finished Height of 70"
- Weight Capacity Not To Exceed  
1000 lbs. Total Weight



w/ Rubber Casters		w/ Poly Casters		Shelf Size	Approx. Wt.
Model #	Price	Model #	Price		
MC-1836R	\$1165	MC-1836P	\$1260	18" x 36"	43 lbs.
MC-1848R	1265	MC-1848P	1360	18" x 48"	55 lbs.
MC-1860R	1441	MC-1860P	1536	18" x 60"	86 lbs.
MC-2436R	1333	MC-2436P	1428	24" x 36"	62 lbs.
MC-2448R	1441	MC-2448P	1536	24" x 48"	76 lbs.
MC-2460R	1605	MC-2460P	1700	24" x 60"	98 lbs.

FOR ADDITIONAL SHELVING, SEE PAGE 152.

### WIRE UTILITY CARTS

- 3 Chrome Wire Shelves
- Tubular Numbered Handles
- 12 Plastic Split Sleeves
- 32" Finished Height
- 4 - Swivel Casters (2 w/ Brakes & Donut Bumpers)



Rubber Casters		Poly Casters		Size	Approx. Wt.	Approx. Cu. Ft.
Model #	Price	Model #	Price			
WUC-1836R	\$1029	WUC-1836P	\$1124	18" x 36"	53 lbs.	3
WUC-1842R	1092	WUC-1842P	1187	18" x 42"	55 lbs.	4
WUC-2436R	1195	WUC-2436P	1290	24" x 36"	58 lbs.	4
WUC-2442R	1237	WUC-2442P	1332	24" x 42"	61 lbs.	5

800 lb. Capacity      1000 lb. Capacity

### UTILITY CART HANDLES

34" Tubular Numbered Posts  
(Fits EC-25 And EC-26 Casters)

Model #	Price	Width
UCH-18	\$134 ea.	18"
UCH-24	154 ea.	24"



### SOLID STAINLESS STEEL SHELVES

Use With Chrome Posts Only  
(Posts Not Included)

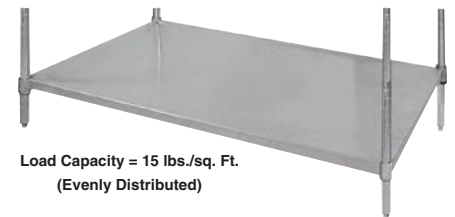

Load Capacity = 15 lbs./sq. Ft.  
(Evenly Distributed)

Model #	Price	Width
SH-1824	\$461 ea.	18" x 24"
SH-1836	579 ea.	18" x 36"
SH-1842	620 ea.	18" x 42"
SH-1848	690 ea.	18" x 48"
SH-1860	834 ea.	18" x 60"

# WIRE SHELVING

## Specialty Wire Shelving & Accessories

### WALL SHELF MOUNTING BRACKETS

Single Mount Includes 2 Brackets & 4 Collar Filler Caps

Double Mount Includes 1 Bracket

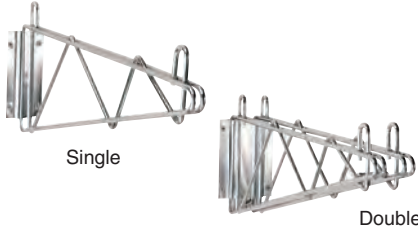

Chrome	Green Epoxy	Price	Size	Approx. Wt.
<b>SINGLE BRACKET</b>				
SB-14	GB-14	\$158	14"	2 lbs.
SB-18	GB-18	194	18"	3 lbs.
<b>DOUBLE BRACKET (For Adjoining Shelves)</b>				
DB-14	GDB-14	\$185	14"	3 lbs.
DB-18	GDB-18	240	18"	4 lbs.

### WALL MOUNTED SHELVING SYSTEM

Mounting Hardware Included • Shelves Sold Separately

- End Mount Kit**
- 4 Single Shelf Brackets
  - 2 - 34" Posts
  - Collar Filler Caps

AB2-14 **\$354**    AB2-18 **\$471**  
14" Wide    18" Wide

- Mid-Mount Kit**
- 2 Double Shelf Brackets
  - 1 - 34" Posts
  - For Adjoining Shelves

ABM2-14 **\$245**    ABM2-18 **\$289**  
14" Wide    18" Wide

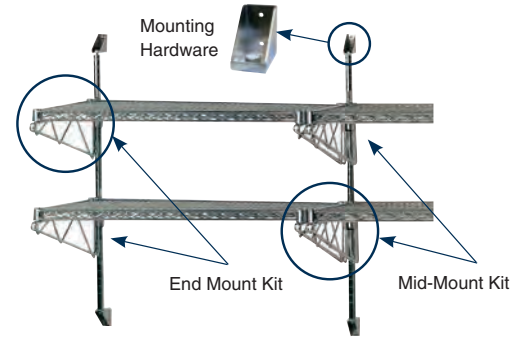

For Additional Tiers, Order Larger Posts On Page 150 With EC-50 Mounting Hardware For Each Post And Use The Following Brackets.

### WALL MOUNTED SHELVING SYSTEM EXPANSION KITS

- Includes Adjustable Bracket(s)

2 Single End Mount Brackets

AAB-14 **\$97**  
14" Wide

AAB-18 **\$110**  
18" Wide

1 Double Mid-Mount Bracket

AABM-14 **\$125**  
14" Wide

AABM-18 **\$142**  
18" Wide

Mounting Hardware

- Includes 2 End Mounts & 1 Mid-Mount Per Post

EC-50 **\$79**

## REPLACEMENT PARTS & ACCESSORIES



EC-5	Post Clamp	.....	<b>\$29 ea.</b>
EC-10	Replacement Leveling Foot	.....	<b>20 ea.</b>
EC-11	Foot Plate	.....	<b>27 ea.</b>
EC-15	Chrome Collar Filler Caps	.....	<b>24 /pack</b>
(For Add-Shelving and Wall Mounted Shelves - 4 per pack)			
EC-16	Plastic Post Cap (4 pair per pack)	.....	<b>21 /pack</b>
EC-20	Tapered Split Sleeves (4 per pack)	.....	<b>24 /pack</b>
EC-30	S Hooks for add-shelving (2 pair per pack)	.....	<b>36 /pack</b>
EC-40	Black Label Holder (3" x 1")	.....	<b>36 ea.</b>

### CASTERS FOR WIRE SHELVING

5" Swivel Stem Casters (2 w/ Brakes & 4 - Donut Bumpers)

Load Capacity Is 500 Lbs. Per Set.



Rubber

EC-25 **\$413**  
Set of 4



Poly

EC-26 **\$508**  
7Set of 4

THESE CASTERS ARE FOR WIRE SHELVING UNITS ONLY.

See Page 71 For S/S Worktable Casters.

## ADVANCE TABCO WARRANTY

### General Terms for all Advance Tabco items (including those listed below):

- Warranty applies in the 48 contiguous United States only
- ALL WARRANTY WORK MUST BE AUTHORIZED BY THE FACTORY BEFORE ANY WORK IS PERFORMED. Work performed without prior authorization shall be covered under this warranty only at the sole discretion of Advance Tabco
- At no time will expenses to be paid under warranty exceed the original cost of the item
- Routine maintenance and wear items are not covered by warranty.
- Repair parts are sent by ground transportation. Any expedited freight charges will be at the expense of the end user
- Warranty applies only under conditions of normal use and does not apply to defects which result from negligence, misuse, freight damage, improper installation or accidents.
- Warranty does not include any coverage for loss of business, damages, freight or other miscellaneous expenses incurred due to the defect or in servicing the unit.
- This warranty is made in lieu of all other warranties express or implied and no additional warranties express or implied, including one of merchantability or fitness for a particular purpose are given.
- If defects are the result of **freight or handling damage** your first recourse MUST be to notify the delivering freight carrier of the damage. If possible any damage should be noted on the delivery receipt at the time of delivery. Defects due to freight damage should be referred to the freight carrier for correction and compensation (this applies regardless of who was responsible for paying the freight charges or selecting the carrier).
- **Hot Food and Refrigerated Tables and Drop-Ins** are warranted for 12 months from the date of shipment from the factory and include the following terms:
  - Applies only to parts directly related to the electric, gas or refrigeration components of covered items (see below for all other parts)
  - Covers parts and labor during the warranty period (refrigeration components include labor coverage for 12 months from date of shipment or 3 months from date placed into service, with parts covered as described above). Labor performed after hours, as overtime, on weekends or on holidays is not covered by this warranty (end user may authorize and pay such expenses directly to service agency if desired)
  - Includes travel up to 100 miles round trip or 2 hours of travel time (additional travel will be at the end users expense)
- **Refrigeration Compressors for Tables and Drop-ins are eligible for additional optional warranty coverage (if purchased):**
  - Must be purchased at the time the covered unit is ordered from the factory
  - Valid for 60 months from the date of shipment from the factory
  - Covers parts only (no labor, no freight). Applies only to the compressor unit
  - Excludes the cost of refrigerant
- **Refrigerated underbar equipment (Glass Frosters, Bottle Coolers, Back Bar Refrigeration)** is warranted for 24 months from the date of shipment from the factory and includes the following terms:
  - Covers parts and labor during the warranty period. Labor performed after hours, as overtime, on weekends or on holidays is not covered by this warranty (end user may authorize and pay such expenses directly to service agency if desired)
  - Includes travel up to 100 miles round trip or 2 hours of travel time (additional travel will be at the end users expense)
  - Compressors only are warranted for a total of 60 months parts only (36 months parts after the initial 24 month parts and labor coverage)
- **Ware Washing Machines** are warranted for 12 months from the date of shipment from the factory and include the following terms:
  - Covers parts and labor during the warranty period. Labor performed after hours, as overtime, on weekends or on holidays is not covered by this warranty
  - Includes travel up to 100 miles round trip or 2 hours of travel time (additional travel will be at the end users expense)
  - Any repairs or service conducted other than by an authorized service agent will void this warranty
- **All Advance Tabco items not mentioned above (including parts not otherwise covered for hot food and refrigerated units)** are warranted free of defects in workmanship and materials for 90 days from the date of shipment from the factory. Warranty includes parts only (no labor). At Advance Tabco's discretion we may repair or replace the defective item.

## TERMS & CONDITIONS

All previous prices and discounts are hereby withdrawn

- All prices are F.O.B. factory.
- All prices, specifications and discounts subject to change without notice. Prices listed herein do not include Federal Excise, Municipal or other use Tax.
- Orders that are shipped to an active construction site or residential address are subject to additional charges by the carrier. These charges may be applied after shipment.
- Not responsible for any damage while in hands of carrier. Inspect immediately for hidden damage. (For any damage and loss while in transit, promptly file claim against carrier.)
- Merchandise shipped open account to those firms furnishing satisfactory credit references. Terms are 1% Discount - 10 days; Net - 30 days.
- Quotations, unless otherwise stated, are for 60 day acceptance.
- Returns: A 30% handling charge will be applied to all authorized returns. **Minimum charge \$50.00. Equipment older than 90 days is not eligible for returns.**
- A 50% handling charge will be applied to all unauthorized returns.
- Orders for special items are not subject to cancellation without our written consent.
- Our consent must be obtained before defective merchandise is returned. Incoming freight or express charges may be collected and exchanged items will be shipped prepaid.
- On return shipments that we sanction, where orders have been correctly filled out and not defective, the incoming freight or express charges must be prepaid. Credit will then be issued, less a reasonable handling charge and less whatever expense is necessary to put goods in salable condition.
- We are not responsible for any delays in delivery which are beyond our control such as fires, strikes, delays in transportation or any contingencies of similar character.
- All orders subject to acceptance at our office.
- Possession of price list does not constitute an offer to sell.
- Minimum charge on all orders is \$50.00 NET.

## GENERAL SHIPPING INFORMATION

1. We reserve the right to ship via carriers that in our opinion are the most efficient. We will follow customers routing if possible.
2. Unless specified, all orders shipped freight collect.
3. All "Drop Shipments" will be shipped "Prepaid & Charge".
4. Shipper is not responsible for any unauthorized accessorial charges. All charges will be billed back to customer.

## PREPAID FREIGHT CHARGES

- Minimum UPS charge = \$25.00.
- Estimated freight charges added to an invoice will include a nominal administrative charge per freight bill.

## ESTIMATED SHIPPING WEIGHTS ARE TO SERVE AS A GUIDE ONLY!

- Weights are averaged for all models within a given classification. Actual shipping weights may vary from those shown. Correct weight will be shown on your Bill of Lading.

This Price Guide Supersedes August 2025 Price Guide.





NATIONWIDE  
STAINLESS STEEL  
FABRICATION



Selmer, TN



Hauppauge, NY



Denmark, SC



Dyer, TN



Kaufman, TX



Kaufman<sup>2</sup>, TX

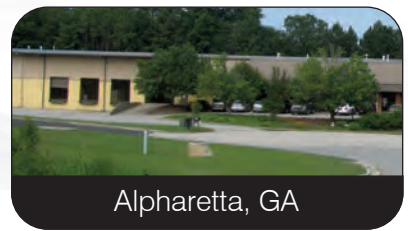

Alpharetta, GA



Jackson, GA



DeKalb, MS



DeKalb<sup>2</sup>, MS

Customer Service Around The Country!

Corporate Headquarters: 325 Wireless Boulevard | Hauppauge | NY | 11788

National Manufacturing: Georgia<sup>2</sup> | Tennessee<sup>2</sup> | Texas<sup>2</sup> | Mississippi<sup>2</sup> | New York | South Carolina

