



SEPTEMBER 2022 PRODUCT & PRICE GUIDE

Pricing Supersedes May 2022 Price Guide



- ➔ Sinks
- ➔ Work Tables
- ➔ Dishtables
- ➔ Cabinets
- ➔ Shelving
- ➔ Food Shields
- ➔ Underbar
- ➔ Aluminum Racks

800-645-3166

customer@advancetabco.com

advancetabco.com



Now That's SMART FABRICATION™
LOOK AT WHAT WE'RE DOING

CUSTOM FABRICATION

- Installation of Buyout Equipment
- Buyout Equipment Can Be Pre-Wired
- Load Centers Added
- Food Shields
- Laminate & Custom Vinyl Wraps Designed In-House

Concealed Load Centers for safety & easy access

Custom Electrical Chases for buyout equipment

Wall Flashing in 16, 18 or 20 Ga. Stainless Steel & polished to a satin finish

CREATE, ACCESSORIZE, UPSELL

Buildatable & Buildasink Are Simple And Easy-To-Use Website Tools That Allow You To Click And Choose Accessories For Either A Work Table Or Sink.



For Smart Fabrication™ Quotes
 Email Smartfab@advancetabco.com or call our Estimating Department at 800-498-6634.

ONLINE SERVICES AVAILABLE AT advancetabco.com



ACCOUNT ACCESS - CREATE A CUSTOMER LOG-IN & FOLLOW THE COMPLETE PROCESS OF YOUR ORDERS

KEEP TRACK OF:

- Print Status
- Shipment Tracking Status
- Real-time Order Status
- Latest Sales Flyer
- Excess Inventory Lists

ALSO AVAILABLE ONLINE:

- Spec Sheets, CAD & Revit Drawings
- Installation Guides
- Product Support
- Photo & Video Library
- Literature Requests

YOU CAN ALSO FIND US ON AUTOQUOTES, KCL CADALOG AND THE FEDA DATA REPOSITORY

CUSTOMER SERVICE IS AVAILABLE TO ASSIST YOU! (8:30AM – 7:00PM EST)

TABLE OF CONTENTS

SINKS & SINK ACCESSORIES

Drop-In Sinks	3-5
Undermount Sinks	5
Hand Washing Sinks	6-11
Mobile Hand Sinks	53
Hand Sink Mods & Accessories	8, 11-13
Mop Sinks & Mop Sink Cabinets	14-15
Multi-Station: Wall Mounted	16-19
Multi-Station: Free-Standing	20-23
Faucets, Drains & P-Traps	8, 11, 13, 36
NSF Regaline Sinks	24-28
NSF Fabricated Sinks	30-33
Sink Mods & Accessories	33-36
Specialty Sinks	29
Mobile & Silver Soak	34
Budget Skullery Sinks	34
Budget Skullery Sink Accessories	34
Floor Troughs, Floor Drains & Water Receptacles	37
Sink Cabinets	53
Integral Sinks	65

TABLES & TABLE ACCESSORIES

Standard Work Tables	38-49
Enclosed Base Tables	50-52
Beverage Tables	52
Demo Tables	55
Tables with Sink	55
Corner Tables	55
Mixer Tables	56
Wall Mounted Tables	56
Equipment Stands	57
Filler Tables	57
Poly Top Tables	60
Wood Top Tables	58-59
Work Table Modifications & Accessories	61-68
Drawers & Accessories	66-67
Casters	68
Electrical Utility Chase	76

FOOD SHIELDS

Food Shields for Multi-Use	69
Food Shields with S/S Shelf	69-70
Food Shields with Glass Top	69, 71
Self Serve Food Shields (No Top)	72
Stationary Food Shields	72
Portable Food Shields	72
Food Shield Accessories	72

LED Lighting	73
--------------	----

STAINLESS STEEL SHELVING

Table Undershelving	68
Table Mounted Shelving	74-76, 79
Specialty Shelving	75-76, 78
Wall Mounted Shelving	77-78
Tubular Drainage Shelving	31, 35
Ceiling Mounted Shelving	79
Shelving Accessories	79
Sorting Shelves For Dishtables	90

POT RACKS

Shelving with Pot Racks	79
Table Mounted	80
Leg Mounted	82
Ceiling Mounted	82
Wall Mounted	82

DISHTABLES

Soil Dishtables	84-85, 87
Clean Dishtables	86-87
3 Compartment Sink w/ Dishtable	88
Condensate Hoods	88
Vent Riser	88
Dishtable Modifications & Accessories	89-90

COUNTERTOPS

Stainless Steel Countertops	59
Integral Sinks	65

CABINETS & WALL FLASHING

Stainless Steel Dish Cabinets	52
Sink Cabinets	53
Wall Cabinets	54
Storage Cabinets	54
Chemical Cabinets	54
Stainless Steel Wall Flashing	78

Underbar Basics™

UNDERBAR EQUIPMENT

Underbar Drop-Ins

Drop-In Water Stations	92
Drop-In Bar Hand Sinks	92-93
Drop-In Ice Bins	92-93
Drop-In Countertop Drain Pans	93

Bar Drink Rails

Drink Rails	93
-------------	----

Free-Standing Bar Sinks

Bar Hand Sinks	94
Bar Hand Sinks with Built-In Soap & Towel Dispensers	94

Bar Hand Sink Modifications & Accessories	96, 120
Bar Sinks	95
Bar Sink/Ice Bin Combos	95

Glass Rinsers

Glass Rinser	93
--------------	----

Ice Bins

Drop-In Ice Bins	92-93
Free-Standing Ice Bins	95-96
Ice Bin & Drainboard Combo	95
Portable Ice Bin	96
Ice Bin with Bottle Storage	96
Beer Boxes	99
Ice Bin Mods & Accessories	92, 118

Bar Drainboards

Free Standing Bar Drainboards	97
Recessed Bar Drainboards	97
Frozen Drink Machine Stands	97
Drainboard Cabinets	100

Blender Stations

Blender Station with Dump Sinks	98
Blender Station Mods & Accessories	98, 118, 120

Uni-Serv Speed Bars

Complete Speed Bar Unit	98
-------------------------	----

Bar Storage Units

Liquor Bottle Displays	99
Glass Rack Storage Cabinets	100
Drainboard Cabinets	100
With Dump Sink & Waste Chute	100
Storage Unit Accessories & Modifications	100, 118, 120

Speed Rails

Stainless Steel Speed Rails	101
Black Plastic Speed Rails	101
Heavy Duty Speed Rails	101

Underbar Mods & Accessories

Underbar Mods & Accessories	118-120
Underbar Faucets	122

PRESTIGE
Signature Series

UNDERBAR EQUIPMENT

ON NEXT PAGE >>>

Continued on Page 2



WARNING: Equipment contained in this Price Guide may expose you to chemicals, including chromium & lead, that are known to the State of California to cause cancer or birth defects or other reproductive harm. For more info, visit www.p65warnings.ca.gov.



= PRODUCTS THROUGHOUT THE PRICE GUIDE WITH THIS ICON ARE SHIPPED VIA UPS

TABLE OF CONTENTS

PRESTIGE Signature Series

UNDERBAR EQUIPMENT

Prestige Modular Bar Die Systems

Exclusive Bar Die System 102-103

Prestige Free-Standing Bar Sinks

Bar Hand Sinks 104-105

Bar Hand Sinks with Built-In

Soap & Towel Dispensers 104

Bar Hand Sinks with Cabinet Base ... 105

Bar Sink Mods

& Accessories 106, 118, 120

Bar Sinks 107

Prestige Ice Bins

Free-Standing Ice Bins 108

Ice Bin & Bottle Storage 108

Beer Box 113

Pass-Thru Ice Bins 113

Prestige Uni-Serv Speed Bars

Complete Speed Bar Unit 113

Prestige Pass-Thru Work Stations

Standard Pass-Thru Workstations ... 114

Overshelves For Pass-Thru

Workstations 114

Prestige Bar Drainboards

Drainboard Fillers 109

Free Standing Bar Drainboards 110

Recessed Bar Drainboards 110

Frozen Drink Machine Stands 110

Drainboard With Blender Station 115

Drainboard Glass Rack Storage 116

Prestige Blender Stations

With Deep Drawn Sink 115

With Drainboard 115

Blender Shelf 117

Prestige Bar Storage Units

Point of Service Cabinet 112

Drainboard Storage Cabinets 112

Glass Rack Storage Cabinets 116

Liquor Bottle Displays 116

Trash Receptacles

Trash Receptacle Cabinets 112

Prestige Speed Rails

Stainless Steel Speed Rails 117

Hang-On Style Speed Rails 117

Under Bar Mods & Accessories

Soda Gun Holder for Prestige®

Pass-Thru Workstations 118

Prestige Mods & Accessories ... 118-120

PORTABLE BARS

Heavy Duty Bars

Heavy Duty Bars 121

With Stainless Steel Doors 121

Standard Bars

Black Mica W/Stainless Steel Top ... 122

Black Mica W/All Stainless Steel

Work Area 122

Portable Bar Options

Portable Bar with Laminates 121

Portable Bar Mods & Accessories 122

HOT/COLD FOOD UNITS

Hot Well Drop-In Units

Standard Drop-In Units 124

Slimline Drop-In Units 124

Hot Well Drop-In Accessories 124

Hot Well Food Tables

Electric Powered Hot Food Tables ... 125

Electric Powered Sealed Well Tables 126

Gas Powered Hot Food Tables 127

Gas Powered Wetbath Tables 128

Solid Top Food Tables

Solid Top Food Tables 129

Cold Well Drop-In Units

Ice-Cooled Drop-In Cold Pan Units .. 130

Refrigerated Drop-In Cold Pan Units... 130

Cold Food Tables

Standard Ice-Cooled Tables 131

Mechanically Assisted

Cold Pans Tables 132

Heavy Duty Food Tables

Electric Sealed Hot Well Tables 133

Refrigerated Cold Well Tables 133

Ice-Cooled Tables 133

Everyday Buffet Tables

Electric Hot Well Buffets 134

Electric Sealed Hot Well Buffets 134

Ice Cooled Buffets 135

Solid Top Buffets 135

Mechanically Assisted

Cold Pan Buffets 136

Cash Register Stands 136

Silverware Stand 136

Everyday Buffet Accessories 137

Food Table Shelving & Parts

Hot/Cold Food Table Shelving 137

Food Shields for Hot/cold Tables 138

Hot Food Table Parts

& Accessories 137-140

LED Lighting for Hot/Cold Tables 139

ALUMINUM RACKS & PANS

Aluminum Racks 141-145

Aluminum Bun Pans 146

Aluminum Rack Accessories 146

Mobile Racks & Carts

Aluminum Pan Trucks 147

Aluminum Dunnage Racks 147

Utility Carts 147

WIRE SHELVING

Chrome & Green Epoxy

Wire Shelving 148-149

Wire Utility Carts 149

Wall Mounted Shelving System 150

Wire Shelving Replacement Parts

& Accessories 150

WARRANTY

Warranty, Terms & Conditions 151

 = PRODUCTS THROUGHOUT THE PRICE GUIDE WITH THIS ICON ARE SHIPPED VIA UPS



DROP-INS

Drop-In Sinks

Holes Punched 4" O.C. For Faucet Hole Revision Order K-472 5176 Cut-Out Size Requires 1-1/4" Radius Corners. Maximum Counter Thickness Is 2".

INCLUDES K-52 LEAD FREE COMPLIANT FAUCET & BASKET DRAIN. (DI-1-25 INCLUDES 2" DRAIN WITH STRAINER PLATE)
(To delete faucet, order K-520MIT and deduct \$24)

All Sinks on this Page Ship Via UPS

ONE COMPARTMENT Countertop Mounted, Self Rim Design

For Residential Finish & Packaging,
Add K-380 \$563



DI-1-5 \$825

10" x 14" x 5" Bowl
Overall: 13" x 19"
Cut-out: 12 1/4" x 18 1/4"
12 lbs. 2 cu. ft. 20 gauge



DI-1-10 \$935

10" x 14" x 10" Bowl
Overall: 13" x 19"
Cut-out: 12 1/4" x 18 1/4"
14 lbs. 2 cu. ft. 20 gauge



DI-1-25 \$919

Space Saver
9" x 9" x 5" Bowl
Overall: 12" x 14"
Cut-out: 11 1/4" x 13 1/4"
8 lbs. 2 cu. ft. 20 gauge



DI-1-1515 \$1056

12 1/4" x 10 1/4" x 6" Bowl
Overall: 15" x 15"
Cut-out: 14 1/4" x 14 1/4"
Requires 1 1/2" Radius Corners
11 lbs. 2 cu. ft. 20 gauge



DI-1-35 \$963

14" x 10" x 5" Bowl
Overall: 17" x 15"
Cut-out: 16 1/4" x 14 1/4"
10 lbs. 2 cu. ft. 20 gauge



DI-1-168 \$1200

18" x 14" x 8" Bowl
Overall: 19" x 19"
Cut-out: 18 1/4" x 18 1/4"
20 lbs. 3 cu. ft. 18 gauge



DI-1-208 \$1284

20" x 16" x 8" Bowl
Overall: 23" x 21"
Cut-out: 22 1/4" x 20 1/4"
20 lbs. 3 cu. ft. 18 gauge



DI-1-2012 \$1474

20" x 16" x 12" Bowl
Overall: 23" x 21"
Cut-out: 22 1/4" x 20 1/4"
20 lbs. 6 cu. ft. 18 gauge



DI-1-5SP \$2159

6" Tapered Side Splash

Splash on Rear and Both Sides
10" x 14" x 5" Bowl
Overall: 13" x 19"
Cut-out: 12 1/4" x 18 1/4"
16 lbs. 2 cu. ft. 20 gauge



DI-1-10SP \$2319

6" Tapered Side Splash

Splash on Rear and Both Sides
10" x 14" x 10" Bowl
Overall: 13" x 19"
Cut-out: 12 1/4" x 18 1/4"
18 lbs. 2 cu. ft. 20 gauge



Splash on All 3 Sides

DI-1-30 \$1408

2" Tapered Side Splash

14" x 10" x 5" Bowl
Overall: 16" x 15"
Cut-out: 15" x 14 1/4"
12 lbs. 2 cu. ft. 20 gauge

IMPROVED!
Stronger Actuator



Includes water filter faucet, grating & drain

DI-1-9 \$1466

Filler Station

9" x 9" x 3" Bowl
Overall: 12" x 14"
Cut-out: 11 1/4" x 13 1/4"
15 lbs. 2 cu. ft. 20 gauge

Optional 12" Tapered Side Splash Upgrade K-1255 \$638

Removable 8" Splash Wrap for Existing Drop-In Sinks \$1133 ea.

Model #	Fits Drop-In Sink:
K-614A	DI-1-25 & DI-1-8
K-614B	DI-1-5 & DI-1-10
K-614C	DI-1-1515
K-614D	DI-1-30 & DI-1-35
K-614E	DI-1-168
K-614F	DI-1-208 & DI-1-2012
K-614G	DI-1-2812



Protect Your Surrounding Area!

The Largest One Compartment Drop-In Sink in the Industry!

DI-1-2812 \$2512

28" x 20" x 12" Bowl
Overall: 31" x 25"
Cut-out: 30 1/4" x 24 1/4"
47 lbs. 7 cu. ft. 16 gauge



Supplied with K-53 Lead Free Compliant Faucet & Basket Drain
(To delete faucet, Order K-530MIT and deduct \$24)

WARNING: Equipment that includes a faucet may expose you to chemicals, including lead, that are known to the State of California to cause cancer or birth defects or other reproductive harm. For more info, visit www.p66warnings.ca.gov

DROP-INS

Drop-In Sinks



= Ship Via UPS

Holes Punched 4" O.C. For Faucet Hole Revision Order K-472 5176. Cut-Out Size Requires 1-1/4" Radius Corners. Maximum Counter Thickness Is 2".

INCLUDES K-50 LEAD FREE COMPLIANT FAUCET & BASKET DRAIN (To delete faucet, order K-500MIT and deduct \$24)

TWO COMPARTMENT

Countertop Mounted, Self Rim Design

THREE COMPARTMENT

Countertop Mounted, Self Rim Design



DI-2-10 \$1850

18" x 14" x 10" Bowl
Overall: 25 1/2" x 19"
Cut-out: 24 3/4" x 18 1/4"
26 lbs. 4 cu. ft. 20 gauge



DI-2-2012 \$2910

26" x 16" x 12" Bowl
Overall: 45 1/2" x 21"
Cut-out: 44 3/4" x 20 1/4"
42 lbs. 9 cu. ft. 18 gauge



DI-2-1410 \$2781

14" x 16" x 10" Bowl
Overall: 23 1/2" x 21"
Cut-out: 32 3/4" x 20 1/4"
35 lbs. 6 cu. ft. 18 gauge



DI-2-208 \$2275

20" x 16" x 8" Bowl
Overall: 45 1/2" x 21"
Cut-out: 44 3/4" x 20 1/4"
40 lbs. 6 cu. ft. 18 gauge

DI-3-10 \$2796

10" x 14" x 10" Bowl
Overall: 38" x 19"
Cut-out: 37 1/4" x 18 1/4"
34 lbs. 5 cu. ft. 20 gauge



DI-3-1410 \$3747

16" x 14" x 10" Bowl
Overall: 50" x 21"
Cut-out: 49 1/4" x 20 1/4"
38 lbs. 8 cu. ft. 18 gauge



DI-3-1612 \$4221

16" x 20" x 12" Bowl
Overall: 56" x 25"
Cut-out: 55 1/4" x 24 1/4"
60 lbs. 12 cu. ft. 18 gauge
Includes a K-53 Faucet. To delete, order K-530MIT & deduct \$24

DID YOU KNOW? 2 & 3 Compartment Drop-In Sinks are N.S.F. Approved when only used in Mobile Food Carts and Kiosks.

FAUCETS & SPOUTS

Deck Mounted Faucets, Spouts & Mounting Clips

Drinking Bubbler
K-47 \$1057



8" Swing Spout
K-50 \$377



Water Filler Faucet
K-54 \$744
8-1/4" High
K-54A \$845
12" High



Swing Spout Faucet & Spray
K-58 \$444



Mounting Clips Extended



For Countertops Over 1/8" & up to 2" Thick
Quantity supplied (4-Pack), varies based on drop-in sink ordered.

Deck Mounted Single Handle Faucet
K-48 \$740



3-1/2" Gooseneck
K-52 \$331



Large 8-1/2" Spout Gooseneck
K-55 \$626



EXTRA HEAVY DUTY Gooseneck
K-62 \$644



Upgrade
K-28 \$21

12" Swing Spout
K-53 \$626



Wrist Handles for Deck Mt. Faucets
K-316-LU \$167



Deck Mounted Faucet with Wrist Handles
K-56 \$473



6" Deck Mounted Extended Faucet with Wrist Handles
K-208 \$853



FAUCET REPAIR KITS*
For K-50, K-52, K-53, K-55, K-56
K-00B \$168

(2 Cartridges & 2 Handles Per Set)
*Can Only Be Used On Faucets Purchased After January 2019. For Older Faucets, Consult Customer Service.

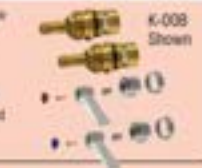

For K-54 & K-54A Filter Faucet

K-02 \$140

Purchased from 2016 to 2019



K-02A \$140

Purchased before 2016 or after 2019

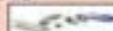

WARNING: Equipment that includes a faucet may expose you to chemicals, including lead, that are known to the State of California to cause cancer or birth defects or other reproductive harm. For more info, visit www.p66arnings.ca.gov.

SMART SERIES™ Countertop Mounted, Self Rim Design

Maximum Counter Thickness is 2". 8" O.C. Faucet Holes: Unit punched with 1-1/4" Diameter for the hot & cold water supply lines. Center hole punched with 1" Diameter. For Faucet Hole Revision Order K-472 5176.

- 18 Gauge, Seamless Deep Drawn Self Rimming Stainless Steel Bowls.
- Bowls Are Sound Deadened.
- Flat Deck Allowing More Faucet Options.
- Units Feature Advance Tabco's Smart Finish.
- Faucet Optional

SINGLE BOWL DROP-IN SINKS

Model #	Price	O.A. Size L x W	Bowl Size L x W	Cut-Out Size (1 1/4" Radius Corners)	Wt.	Cu. Ft.
SS-1-1319-10	\$1527	13" x 19"	14" x 10" x 10"	12 1/4" x 18 1/4"	14 lbs.	2
SS-1-1715-7	1527	17" x 19"	14" x 10" x 7 1/2"	16 1/4" x 14 1/4"	12 lbs.	2
SS-1-1715-10	1702	17" x 15"	14" x 10" x 10"	16 1/4" x 14 1/4"	14 lbs.	3
SS-1-1919-7	1814	19" x 19"	16" x 14" x 7 1/2"	18 1/4" x 18 1/4"	16 lbs.	3
SS-1-1919-10	1915	19" x 19"	16" x 14" x 10"	18 1/4" x 18 1/4"	18 lbs.	4
SS-1-1919-12	1993	19" x 19"	16" x 14" x 12"	18 1/4" x 18 1/4"	20 lbs.	4
SS-1-2321-10	2155	23" x 21"	20" x 16" x 10"	22 1/4" x 20 1/4"	22 lbs.	6
SS-1-2321-12	2291	23" x 21"	20" x 16" x 12"	22 1/4" x 20 1/4"	24 lbs.	6

DOUBLE BOWL DROP-IN SINKS

SS-2-3321-10	2465	33 1/2" x 21"	14" x 16" x 10"	32 3/4" x 20 1/4"	35 lbs.	6
SS-2-3321-12	2688	33 1/2" x 21"	14" x 16" x 12"	32 3/4" x 20 1/4"	37 lbs.	9
SS-2-4521-10"	2893	45 1/2" x 21"	20" x 16" x 10"	44 3/4" x 20 1/4"	39 lbs.	9
SS-2-4521-12"	3161	45 1/2" x 21"	20" x 16" x 12"	44 3/4" x 20 1/4"	40 lbs.	10

SS-1-1715-7
Shown



SS-1-2321-10
Shown



SS-2-3321-10
Shown



LAUNDRY ROOM SINK



- 16 Gauge
- Three 4" O.C. Holes*
- Bowl Size: 24" x 18" x 14"***
- Overall Size: 27" x 23"
- Cutout: 26 1/4" x 20 1/4"

LS-2418-14RE \$3908

** Requires 30" Wide Countertop (Front to Back)

*Shown with Faucet Hole Revision K-472 5176

STAINLESS STEEL SINK GRIDS

- Perforated Grid
- Raised Bottom
- Side Notches for Easy Removal

K-610 \$1066

(Specify Bowl Size When Ordering)



UNDERMOUNTS

Undermount Bowls are suitable to be welded by others into stainless steel products. Multiple compartment assemblies available. Call for pricing.

- 3 1/2" Drain Opening
- 1-1/4" Outside Flange



2028A-12 Shown



CO-1014A-10RE Shown

Model #	Price	# Of Compartments	Gauge	Bowl Size LxWxD	Radius	O.D. Trim Size
1014B-05	\$553	1	20	10" x 14" x 5"	2"	12 1/2" x 16 1/2"
1014A-10	672	1	20	10" x 14" x 10"	2"	12 1/2" x 16 1/2"
1014A-10A	867	1	18	10" x 14" x 10"	2"	12 1/2" x 16 1/2"
CO-1014A-10RE*	1222	1	18	10" x 14" x 10"	2"	12 1/2" x 16 1/2"
1014-210-BAD	1494	2	18	10" x 14" x 10"	2"	25" x 16 1/2"
1014-310-BAD	2345	3	18	10" x 14" x 10"	2"	37 1/2" x 16 1/2"
CO-1416A-10RE*	1296	1	18	14" x 16" x 10"	3"	12 1/2" x 18 1/2"
1416-212-BAD	2485	2	18	14" x 16" x 12"	3"	30" x 18 1/2"
1416-312-BAD	3816	3	18	14" x 16" x 12"	3"	49 1/2" x 18 1/2"
1620A-10	1076	1	18	16" x 20" x 10"	3"	18 1/2" x 22 1/2"
1620A-12	1279	1	18	16" x 20" x 12"	3"	18 1/2" x 22 1/2"
1620A-14A	1584	1	14	16" x 20" x 14"	3"	18 1/2" x 22 1/2"
1620-212-BAD	2739	2	16	16" x 20" x 12"	3"	37" x 22 1/2"
1620-312-BAD	4198	3	16	16" x 20" x 12"	3"	55 1/2" x 22 1/2"
1824A-12	2243	1	18	18" x 24" x 12"	3"	20 1/2" x 26 1/2"
1824A-14A	2515	1	14	18" x 24" x 14"	3"	20 1/2" x 26 1/2"
2020A-12	1432	1	18	20" x 20" x 12"	3"	22 1/2" x 22 1/2"
2020A-14	1546	1	18	20" x 20" x 14"	3"	22 1/2" x 22 1/2"
2028A-12	2373	1	16	20" x 28" x 12"	3"	22 1/2" x 30 1/2"
2028A-14A	2665	1	14	20" x 28" x 14"	3"	22 1/2" x 30 1/2"
2424A-14A	2792	1	14	24" x 24" x 14"	3"	26 1/2" x 26 1/2"

* Includes Residential Finish & Packaging. Add K-350 \$500 for Other Models to Add Residential Finish & Packaging.

WARNING: Equipment that includes a faucet may expose you to chemicals, including lead, that are known to the State of California to cause cancer or birth defects or other reproductive harm. For more info, visit www.p66warnings.ca.gov.

HAND SINKS

Hand Washing Sinks



To delete faucet, order K-59OMIT and deduct \$24

All Sinks On This Page Ship Via UPS



All Sinks on this Page

STANDARD UNITS

Bowl Size: 10" x 14" x 5" • Overall Size: 15 1/4" x 17 1/4" Unless Otherwise Specified
Includes K-59 Splash Mount Faucet, 3-1/2" Basket Drain & Wall Bracket (Unless Otherwise Specified)



7-PS-60 \$839
Standard Unit
13 lbs. 2 cu. ft. 20 gauge



7-PS-68 \$998
K-316 Splash Mount
Wrist Handle Faucet
13 lbs. 2 cu. ft. 20 gauge



7-PS-67 \$928
Lever Operated
15 lbs. 2 cu. ft. 20 gauge



7-PS-50 \$1097
Lever Operated
with Overflow & P-Trap
15 lbs. 2 cu. ft. 20 gauge



7-PS-54 \$1014
1 1/2" P-Trap
15 lbs. 2 cu. ft. 20 gauge



7-PS-20 \$875
K-22 Deck Mount Faucet
15 lbs. 3 cu. ft. 20 gauge
Overall Size:
17-1/4" x 17-1/4"

SIDE SPLASH UNITS

Bowl Size: 10" x 14" x 5" • Overall Size: 15 1/4" x 17 1/4" Unless Otherwise Specified
Includes 7-3/4" High Welded Side Splashes, K-59 Splash Mount Faucet, 3-1/2" Basket Drain & Wall Bracket (Unless Otherwise Specified)



7-PS-66R or L \$1324
Right or Left Side Splash
13 lbs. 2 cu. ft. 20 gauge

Unit Shown:
7-PS-66R



7-PS-66 \$1428
Standard Unit
19 lbs. 2 cu. ft. 20 gauge



7-PS-66W \$1536
K-316 Splash Mt. Faucet
w/ Wrist Handles
19 lbs. 2 cu. ft. 20 gauge



7-PS-40 \$1744
Lever Operated
With Overflow & P-Trap
20 lbs. 2 cu. ft. 20 gauge



7-PS-76 \$2228
Full Length Removable
Utility Tray
K-59 Splash Mt. Faucet
Lever Operated
With Overflow & P-Trap
12" High Welded Side Splashes
24 lbs. 2 cu. ft. 20 gauge



7-PS-87 \$2881
Towel & Soap Dispenser
K-316 Splash Mt. Faucet
with Wrist Handles
Lever Operated
With Overflow & P-Trap
34 lbs. 10 cu. ft. 20 gauge



You Can Add Side Splashes To Any Hand Sink
See Page 12



7-PS-73 \$2798
7 3/4" High Side Splashes
Towel Dispenser
Deck Mt. Soap Dispenser
K-123 Splash Mt. Faucet
31 lbs. 5 cu. ft. 20 gauge

WARNING: Equipment that includes a faucet may expose you to chemicals, including lead, that are known to the State of California to cause cancer or birth defects or other reproductive harm. For more info, visit www.p66warnings.ca.gov

HAND SINKS

Hand Washing Sinks

NSF All Sinks on this Page

All Sinks On This Page Ship Via UPS

SOAP & TOWEL DISPENSER UNITS

Bowl Size: 10" x 14" x 5" • Overall Size: 15 1/4" x 17 1/4"

Includes C-Fold Style Towel Dispenser, Liquid Soap Dispenser, K-59 Splash Mount Faucet, 3-1/2" Basket Drain & Wall Bracket (Unless Otherwise Specified)
To delete faucet, order K-590MIT and deduct \$24



7-PS-69 \$3099
Splash Mounted Faucet
With Wrist Handles
Lever Operated With
Overflow & P-Trap
Side Support Brackets
K-69 (T&S) Faucet
35 lbs. 6 cu. ft. 20 gauge



7-PS-79 \$2094
Standard Unit
32 lbs. 10 cu. ft. 20 gauge



7-PS-80 \$2296
Lever Operated
With Overflow & P-Trap
32 lbs. 10 cu. ft. 20 gauge

ALL-IN-ONE
UNIT



7-PS-85 \$2554
P-Trap & Skirt
35 lbs. 6 cu. ft. 20 gauge



7-PS-131 \$5192
All-in-One
Touchless Soap Dispenser
Towel Dispenser
7-3/4" High Side Splashes
K-175 Faucet
40 lbs. 10 cu. ft. 20 gauge

UPGRADE TO TOUCHLESS SOAP DISPENSER
Battery Powered (4 "AA" Batteries Required, Not Included)
Add **7-PS-104 \$441** Plus **7-PS-120MIT (Deduct -\$49)**
Excludes 7-PS-131



UNDERMOUNT TOWEL DISPENSER UNITS

7-PS-41 \$6200

A.D.A. Compliant Tapered Bowl Design
Hands Free Operated Faucet
Undermount Towel Dispenser
1-1/2" Drain w/ Flat-Top Strainer Plate
16 Gauge Skirt with Enclosed Bottom
For Storage w/ Removable Access Panel
43 lbs. 8 cu. ft. 18 gauge



Available with K-123 "T" Spout
Splash Mt. Wrist Handle Faucet
7-PS-46 \$4114

For More A.D.A. Compliant
Sinks, please see page 10.



7-PS-65 \$2440

Undermount Towel Dispenser
with Skirt
Deck Mounted Soap Dispenser
K-22 Deck Mounted Faucet
35 lbs. 10 cu. ft. 20 gauge

12" WIDE SPACE SAVER UNITS

Bowl Size: 9" x 9" x 5" • Overall Size: 16" x 12"
Includes 2" Drain With Flat Top Strainer & Wall Bracket



7-PS-22 \$1081
K-22 Deck Mounted Faucet
12 lbs. 2 cu. ft. 20 gauge



7-PS-23 \$1130
K-123 Splash Mounted Faucet
12 lbs. 2 cu. ft. 20 gauge



7-PS-53 \$3218
K-175 Splash Mt. Electronic Faucet
12 lbs. 2 cu. ft. 20 gauge



7-PS-56 \$1729
K-123 Splash Mounted Faucet
8" High Side Splashes
14 lbs. 2 cu. ft. 20 gauge



7-PS-88 \$2269
Undermount Towel Dispenser
Deck Mt. Soap Dispenser
K-22 Deck Mt. Faucet
23 lbs. 10 cu. ft. 20 gauge

SOAP/TOWEL UNITS



7-PS-83 \$2122
Towel Dispenser
Deck Mt. Soap Dispenser
K-22 Deck Mt. Faucet
27 lbs. 5 cu. ft. 20 gauge



7-PS-89 \$4039
7 3/4" High Side Splashes
Towel Dispenser
Deck Mt. Soap Dispenser
K-175 Splash Mt. Electronic Faucet
40 lbs. 5 cu. ft. 20 gauge



7-PS-84 \$2211
Towel Dispenser
Deck Mt. Soap Dispenser
K-123 Splash Mt. Faucet
27 lbs. 5 cu. ft. 20 gauge



7-PS-73 \$2798
7 3/4" High Side Splashes
Towel Dispenser
Deck Mt. Soap Dispenser
K-123 Splash Mt. Faucet
31 lbs. 5 cu. ft. 20 gauge

WARNING: Equipment that includes a faucet may expose you to chemicals, including lead, that are known to the State of California to cause cancer or birth defects or other reproductive harm. For more info, visit www.p66warnings.ca.gov

HANDS-FREE Hand Washing Sinks



All Sinks on this Page



All Sinks On This Page Ship Via UPS

HANDS-FREE ELECTRONIC OPERATED FAUCETS

Bowl Size: 10" x 14" x 5" • Overall Size: 15 1/4" x 17 1/4" Includes K-175 AC/DC Powered Electronic Operated Faucet

7-PS-131
\$5192
All-in-One
Touchless Soap Dispenser
Towel Dispenser
7-3/4" High Side Splashes
K-175 Faucet
40 lbs. 10 cu. ft. 20 gauge



7-PS-51 \$3182
Equal to 7-PS-50 w/ K-175 Faucet
21 lbs. 2 cu. ft. 20 gauge

7-PS-81 \$4381
Equal to 7-PS-80 w/ K-175 Faucet
32 lbs. 10 cu. ft. 20 gauge

7-PS-52 \$4175
Equal to 7-PS-81. Excludes Lever Drain, P-Trap and Overflow
31 lbs. 10 cu. ft. 20 gauge

Upgrade To Touchless Soap Dispenser:
Add 7-PS-104 \$441
Plus 7-PS-120MIT (Deduct -\$49)



7-PS-61 \$2927
Equal to 7-PS-60 w/ K-175 Faucet
19 lbs. 2 cu. ft. 20 gauge

7-PS-91 \$4228
Equal to 7-PS-90 w/ K-175 Faucet
41 lbs. 10 cu. ft. 20 gauge



KNEE VALVE OPERATED FAUCETS

Includes Single Knee Valve (With Built-in Mixing Valve), K-121 Splash Mt. Gooseneck Spout, Skirt, 3-1/2" Basket Drain (Otherwise Noted) & Wall Bracket

7-PS-62 \$2137
Standard Unit
Bowl Size: 10" x 14" x 5"
Overall : 15-1/4" x 17-1/4"
25 lbs. 2 cu. ft. 20 gauge



7-PS-30 \$2301
Large Bowl Size
Bowl Size: 16" (F/B) x 14" x 6"
Overall : 21-1/4" (F/B) x 17-1/4"
33 lbs. 8 cu. ft. 18 gauge



7-PS-59 \$2763
Side Splash Unit
Bowl Size: 10" x 14" x 5"
Overall : 15-1/4" x 17-1/4"
7-3/4" Side Splashes
31 lbs. 2 cu. ft. 20 gauge



7-PS-63 \$2137
Spacesaver
1-1/2" Basket Drain
Bowl Size: 9" x 9" x 5"
Overall : 12-1/4" x 16"
20 lbs. 8 cu. ft. 18 gauge



7-PS-58 \$2760
Spacesaver With Side Splashes
7-3/4" Side Splashes
1-1/2" Basket Drain
Bowl Size: 9" x 9" x 5"
Overall : 12-1/4" x 16"
26 lbs. 8 cu. ft. 18 gauge



7-PS-78 \$2666
Large Bowl Size
Bowl Size: 16" x 20" x 6"
Overall : 24-3/4" x 21-7/8"
40 lbs. 8 cu. ft. 18 gauge



7-PS-82 \$2927
Towel & Soap Dispenser
Bowl Size: 10" x 14" x 5"
Overall : 15-1/4" x 17-1/4"
38 lbs. 6 cu. ft. 20 gauge

Upgrade To Touchless Soap Dispenser:
Add 7-PS-104 \$441
Plus 7-PS-120MIT (Deduct -\$49)



You Can Put A Skirt On Any Handsink
(Excludes sinks with existing bases or skirts. Sinks Not Included)

7-PS-31 \$746 Fits Hand Sinks with 10" x 14" Bowl and Splash Mounted Faucets	7-PS-31A \$807 Fits Hand Sinks with 9" x 9" Bowl Only	7-PS-31B \$838 Fits Hand Sinks with 10" x 14" Bowl and Deck Mounted Faucets
--	---	---

DID YOU KNOW?



KNEE & PEDAL VALVE REPLACEMENT PARTS & FAUCETS

Foot Pedal Valve Replacement
Combo. H/C
Single Pedal
K-103 \$669
Foot Pedal with Retaining Pin Only
K-17 \$167



Knee Valve Replacement
Combo. H/C
Single Pedal
K-104 \$840
Knee Pedal with Retaining Pin Only
K-18 \$167



Splash Mounted Gooseneck Spout
K-121
\$197



Replacement Check Valves
K-19
\$33 set of 2



Mixing Valve & Retainer
K-19A
\$28



Foot Pedal Assembly w/Floor Bracket
7-PS-39
\$898



Knee Valve Assembly w/ Mounting Bracket
7-PS-32
\$1071



Thermostatic Mixing Valve
K-425
\$543



Replacement Bonnet for Pedal/Knee Valve (K-103 & K-104, 7-PS-32 & 7-PS-39)
K-01
\$69



WARNING: Equipment that includes a faucet may expose you to chemicals, including lead, that are known to the State of California to cause cancer or birth defects or other reproductive harm. For more info, visit www.p66warnings.ca.gov.



All Sinks on this Page



All Sinks On This Page Ship Via UPS

HANDS-FREE Hand Washing Sinks

FOOT PEDAL VALVE UNITS

Includes Single Pedal Valve (With Built-In Mixing Valve), K-121 Splash Mt. Gooseneck Spout, 3-1/2" Basket Drain & Wall Bracket, Removable Panel for Plumbing Access



7-PS-90 \$2203

Standard Unit
Bowl Size:
10" x 14" x 5"
Overall:
17-1/4" x 15-1/4" x 42"
41 lbs. 10 cu. ft. 20 gauge



7-PS-96 \$2802

Side Splash Unit
7-3/4" High Side Splashes
Bowl Size:
10" x 14" x 5"
Overall:
17-1/4" x 15-1/4" x 42"
41 lbs. 10 cu. ft. 20 gauge



7-PS-18 \$2647

Large Bowl Size
Bowl Size:
10" (F/B) x 14" x 6"
Overall:
21-1/4" (F/B) x 17-1/4" x 42"
50 lbs. 11 cu. ft. 18 gauge



7-PS-86 \$2752

Extra Large Bowl Size
Bowl Size:
16" x 20" x 8"
Overall:
24-3/4" (F/B) x 21-7/8" x 41-1/2"
55 lbs. 16 cu. ft. 20 gauge



Upgrade To Touchless Soap Dispenser,
Add 7-PS-104 \$441
Plus 7-PS-120MIT (Deduct -\$49)

7-PS-99 \$3984

**Towel & Soap Dispenser
Trash Receptacle**
Bowl Size:
10" (F/B) x 14" x 5"
Overall:
17-1/4" (F/B) x 15-1/4" x 42"
59 lbs. 15 cu. ft. 20 gauge



7-PS-95 \$3201

Towel & Soap Dispenser
Bowl Size:
10" (F/B) x 14" x 5"
Overall:
17-1/4" (F/B) x 15-1/4" x 42"
54 lbs. 15 cu. ft. 20 gauge



You Can Put a Pedestal Base On Any Hand Sink

(Excludes Sinks With Existing Bases Or Sinks. Sinks Not Included)



Basic Pedestal Base

7-PS-37 \$836

For 10" x 14" Bowls

7-PS-37B \$1047

For 10" x 14" bowls and
Deck Mounted Faucets

7-PS-37C \$1120

For 16" x 20" Bowls



With Foot Valve

7-PS-33 \$1164

For 10" x 14" Bowls

7-PS-33B \$1469

For 10" x 14" Bowls and
Deck Mounted Faucets

7-PS-33C \$1585

For 16" x 20" Bowls



Add Trash Receptacle

7-PS-29 \$948

Use above model number with
any Pedestal Base Sink or
Stand-Alone Pedestal Base.



Plastic Replacement
Handles 7-PS-38 \$58

SECURITY UNITS

Bowl Size: 10" x 14" x 5" • Require Minimum Security Installations
Includes Heavy Duty Gooseneck Faucet, Concealed 3 1/2" Drain & Wall Bracket



7-PS-747 \$4329

Class 2 Upgrade
45 lbs. 10 cu. ft. 20 gauge

7-PS-727 \$5500

Class 1 Upgrade
Towel Dispenser
Provisions For Installation Of Soap
Dispenser (By Others)
65 lbs. 15 cu. ft. 20 gauge



WARNING: Equipment that includes a faucet may expose you to chemicals, including lead, that are known to the State of California to cause cancer or birth defects or other reproductive harm. For more info, visit www.p66warnings.ca.gov.

HAND SINKS

Hand Washing Sinks

All Sinks On This Page Ship Via UPS

NSF All Sinks on this Page

DID YOU KNOW? You Can Add a K-175 or K-180 Electronic Faucet To Any Hand Sink \$2208 (May require faucet hole revision. See Page 11.)



CONCEALED HAND SINK DRAWER

Take Back Your Countertop Space!

- Easily Installs into Existing Advance Tabco Work Tables/Countertops or Integrates into Custom Fabrication
- Overall Size: 22 5/8" W x 19 7/8" L x 19 1/4" H
- 10" x 14" x 5" Deep Sink Bowl
- Pre-Drilled Holes In Flanges For Easy Mounting
- Integral Drawer Slides For Smooth Operation
- "Safety Stop" Tab
- K-50 Swing Spout Faucet
- 1-1/2" Sink Drain with Strainer Plate
- Drainage Pan with 1-1/2" Drain & Strainer Plate (Drain Pipe & Fittings Included.)



7-PS-47 \$3813
70 lbs. 7 cu. ft.
18 gauge exterior
16 gauge interior

A.D.A. UNITS FOR THE PHYSICALLY CHALLENGED

Bowl Size: 16" x 14" x 5". Overall Size: 20" x 24" • Includes 1-1/2" Drain With Strainer Plate & Wall Bracket 



7-PS-77-E \$5930 

Tapered Bowl Design
Hands Free Operated Faucet
Deck Mount Soap Dispenser
16 Gauge Skirt with Enclosed Bottom w/ Removable Access Panel
65 lbs. 8 cu. ft. 18 gauge

7-PS-77-W \$3846 

Same As Above with 4" O.C. Wrist Handle Faucet



7-PS-41 \$6200 

Tapered Bowl Design with Undermount Towel Dispenser
Hands Free Operated Faucet
Deck Mount Soap Dispenser
16 Gauge Skirt with Enclosed Bottom w/ Removable Access Panel
65 lbs. 8 cu. ft. 18 gauge

7-PS-46 \$4114 

Same As Above with 4" O.C. Wrist Handle Faucet



7-PS-75 \$2174 

Same As 7-PS-25 With 8" O.C. Faucet Holes Only (Faucet Not Included)

7-PS-751 \$2174 

Same As 7-PS-75 With Single Hole (Faucet Not Included)



7-PS-25 \$2796 

K-208 Deck Mounted Faucet with Wrist Handles
Deck Mounted Soap Dispenser
Wall Support Brackets
25 lbs. 8 cu. ft. 18 gauge



7-PS-26 \$5235 

Same As 7-PS-25 With K-180 Hands Free AC/DC Operated Faucet
Deck Mounted Soap Dispenser

COUNTERTOP INSTALLED HAND SINKS

- 4" High Side Splashes
- K-52 Deck Mounted Faucet
- Deck Mounted Soap Dispenser
- Built-In Towel Dispenser
- 3-1/2" Basket Drain



7-PS-42 \$3908

Bowl Size: 10" x 14" x 5"
Overall Size: 18-1/4" x 17-5/8"
30 lbs. 2 cu. ft. 20 gauge



7-PS-42A \$3908

Bowl Size: 9" x 9" x 5"
Overall Size: 17-3/8" x 13"
26 lbs. 2 cu. ft. 20 gauge



7-PS-43 \$4524

Bowl Size: 10" x 14" x 5"
Overall Size: 18-1/4" x 17-5/8"
36 lbs. 2 cu. ft. 20 gauge

4" High Side Splashes
Deck Mounted Gooseneck Spout
Knee Operated Valve
Deck Mounted Soap Dispenser
Built-In Towel Dispenser
3-1/2" Basket Drain

7-PS-43 \$4524

Bowl Size: 10" x 14" x 5"
Overall Size: 18-1/4" x 17-5/8"
36 lbs. 2 cu. ft. 20 gauge

For Factory Installation, Add TA-303 \$613. Can Be Purchased Separately For In-Field Installation.

7-PS-43 \$4524

Bowl Size: 10" x 14" x 5"
Overall Size: 18-1/4" x 17-5/8"
36 lbs. 2 cu. ft. 20 gauge

7-PS-43 \$4524

Bowl Size: 10" x 14" x 5"
Overall Size: 18-1/4" x 17-5/8"
36 lbs. 2 cu. ft. 20 gauge

4" High Side Splashes
Deck Mounted Gooseneck Spout
Knee Operated Valve
Deck Mounted Soap Dispenser
Built-In Towel Dispenser
3-1/2" Basket Drain

7-PS-43 \$4524

Bowl Size: 10" x 14" x 5"
Overall Size: 18-1/4" x 17-5/8"
36 lbs. 2 cu. ft. 20 gauge

For Factory Installation, Add TA-303 \$613. Can Be Purchased Separately For In-Field Installation.

LARGE SIZE SINK BOWLS

Includes K-59 Splash Mt. Gooseneck Faucet, 3-1/2" Basket Drain, Wall Bracket w/ 2 Support Brackets



7-PS-45 \$1455
Bowl Size: 16" x 20" x 8"
Overall Size: 24 3/4" x 21 7/8"
31 lbs. 8 cu. ft. 18 gauge

7-PS-49 \$1360
Bowl Size: 14" x 16" x 8"
Overall Size: 19-1/4" x 19"
30 lbs. 8 cu. ft. 18 gauge

SPECIAL PURPOSE UNITS

Bowl Size: 10" x 14" x 5" • Overall Size: 15 1/4" x 17 1/4" (Excludes 7-PS-72 & 7-PS-44)
Includes 3-1/2" Basket Drain & Wall Bracket



7-PS-55 \$1526

Gooseneck Faucet w/ Eye Wash Attachment
15 lbs. 3 cu. ft. 20 gauge



7-PS-64 \$1360

Splash Mounted Gooseneck Faucet
Tubular Support Brackets
25 lbs. 2 cu. ft. 20 gauge

PATENTED DESIGN



7-PS-72 \$1558

H.A.C.C.P. Compliant Slow Self-Closing Metering Faucet with Mixing Valve
15 lbs. 3 cu. ft. 20 gauge

Overall Size: 17-1/4" x 17-1/4"



7-PS-44 \$3573

Body Activated Valve
K-121 Splash Mounted Gooseneck Spout
28 lbs. 2 cu. ft. 18 gauge

Overall Size: 15-1/4" x 17-1/4"

10  **WARNING:** Equipment that includes a faucet may expose you to chemicals, including lead, that are known to the State of California to cause cancer or birth defects or other reproductive harm. For more info, visit www.p66warnings.ca.gov



All Sinks on this Page

All Items On This Page Ship Via UPS

HAND SINKS

FAUCETS OMITTED

Bowl Size: 10" x 14" x 5". Overall Size: 15 1/4" x 17 1/4"



7-PS-70 \$766
Equal To 7-PS-60 Without Faucet



7-PS-71 \$842
Equal To 7-PS-70 With Single Hole Punch



7-PS-20-NF \$835
Equal To 7-PS-20 Without Faucet



7-PS-66-NF \$1386
Equal To 7-PS-66 Without Faucet

HAND SINK FAUCETS & SPOUTS



Extra Heavy Duty Splash Mounted Faucet K-69 \$651
4" O.C.
Wrist Handles For K-69 K-416-TS-LU \$492 set



3-1/2" Splash Mounted Faucet K-59 \$331
4" O.C.

3-1/2" Splash Mounted Faucet with Wrist Handles

K-316 \$496
4" O.C.

Wrist Handles For Faucets (Excludes K-69) K-316-LU \$167 set



3-1/2" Gooseneck Spouts
Deck Mount K-120 \$300

Splash Mounted K-121 \$197

Deck Mounted Faucet



K-22 \$304
4" O.C.

ELECTRONIC HANDS FREE FAUCETS



Splash Mt. K-175 \$2208
Deck Mt. K-180 \$2208



Replacement Control Module K-09 \$998



Infra-Red Sensor and Wire Assembly K-14 \$165

"D" SPOUT EXTENDED FAUCETS



Deck Mt. 6" Extended Spout K-124 \$479
4" O.C.



Deck Mt. w/ Wrist Handles K-208 \$653
4" O.C.



Splash Mt. 6" Extended Spout K-123 \$493
4" O.C.



Splash Mt. w/ Wrist Handles K-206 \$624
4" O.C.

SPECIALTY FAUCETS & ADAPTERS



Slow-Released Metered Faucet K-190 \$804



Eye-Wash Attachment K-170 \$658



Hands-Free Wand Spout Not Included K-400 \$135 ea.



Low Flow Aerator .5 GPM K-08 \$50

REPLACEMENT CARTRIDGES WITH HANDLES®

(Set of 2. Includes Cartridges and handles)



For Faucets: K-59, K-123, K-125, K-126, K-206 & K-316
K-00A \$168

For Faucets: K-1, K-11, K-50, K-51, K-52, K-53, K-56, K-124, K-101, K-159, K-160, K-208 & K-240
K-00B \$168

*Can Only Be Used On Faucets Purchased After January 2016. For Older Faucets, Consult Customer Service.

REPLACEMENT FAUCET SPOUTS

Model #	Spout Size/Style	For Faucet Model	Price
K-52SP	3-1/2" Swivel Gooseneck	K-52	\$78
K-55SP	8-1/2" Swivel Gooseneck	K-55	124
K-59SP	3-1/2" Swivel Gooseneck	K-59	78
K-208SP	6" Extended Swivel Gooseneck	K-208	89
K-175SP	4-1/2" Swivel Gooseneck	K-175/K-180	185
K-50SP	8" Swing Spout	K-50	86
K-53SP	12" Swing Spout	K-53	116

Faucet Hole Modifications

Faucet Not Included	Price
K-70 Punch for 8" O.C. Faucet Holes	\$176
K-70A Punch for Single Hole Splash Mt. Faucet	\$176
K-71 Punch for Single Hole Deck Mt. Faucet	\$176

WARNING: Faucets on this page may expose you to chemicals, including lead, that are known to the State of California to cause cancer or birth defects or other reproductive harm. For more info, visit www.cdph.ca.gov

MODS & ACCESSORIES

Hand Sink Modifications & Accessories

 = Ships Via UPS

WELDED SIDE SPLASHES FOR HAND SINKS

Factory Installed Only



7-3/4" HEIGHT SPLASH		12" HEIGHT SPLASH				24" HEIGHT SPLASH		Description		
1 Side Splash	2 Side Splashes	1 Side Splash	2 Side Splashes	2 Side Splashes & Rear Panel*						
Model #	Price	Model #	Price	Model #	Price	Model #	Price			
7-PS-16	\$521	7-PS-17	\$663	7-PS-11	\$634	7-PS-15	\$713	7-PS-28	\$1613	Units w/ 10" x 14" Bowl & Splash Mount Faucet
7-PS-16A	521	7-PS-17A	678	7-PS-11A	634	7-PS-15A	713	7-PS-28A	1613	Units w/ 9" x 9" Bowls
7-PS-16B	553	7-PS-17B	729	7-PS-11B	682	7-PS-15B	761	7-PS-28B	1629	Units w/ 10" x 14" Bowl & Deck Mount Faucet
7-PS-16C	567	7-PS-17C	760	7-PS-11C	713	7-PS-15C	790	7-PS-28C	1723	Units w/ 16" x 20" Bowls
7-PS-16D	615	7-PS-17D	794	7-PS-11D	771	7-PS-15D	879	7-PS-28D	1759	For Handicapped Hand Sinks
7-PS-16E	561	7-PS-17E	743	7-PS-11E	758	7-PS-15E	861	7-PS-28E	1680	Units w/ 14" (FBI) x 16" Bowls
7-PS-16F	561	7-PS-17F	743	7-PS-11F	758	7-PS-15F	861	7-PS-28F	1695	Units w/ 16" (FBI) x 14" Bowls

*24" high splashes include a rear panel that matches the height of the side splashes. Only available as a 2 side design. Single side not offered. Includes rear mounting holes.

BOLT-ON SINGLE PANEL SPLASH FOR HAND SINKS

 All Bolt-On Splashes Ship Via UPS

7-3/4" & 12" Height Bolt-On Splash

(Priced Per Splash. Order 2 for Both Sides)



Includes Holes. Hardware not Included

7-3/4" HEIGHT SPLASH		12" HEIGHT SPLASH		Description
Model #	Price Ea.	Model #	Price Ea.	
7-PS-27	\$209	7-PS-13	\$271	Units w/ 10" x 14" Bowl & Splash Mount Faucet
7-PS-27A	253	7-PS-13A	327	Units w/ 9" x 9" Bowls
7-PS-27B	253	7-PS-13B	362	Units w/ 10" x 14" Bowl & Deck Mount Faucet
7-PS-27C	253	7-PS-13C	377	Units w/ 16" x 20" Bowls
7-PS-27D	287	7-PS-13D	349	For Handicapped Hand Sinks
7-PS-27E	321	7-PS-13E	347	Units w/ 14" (FBI) x 16" Bowls
7-PS-27F	321	7-PS-13F	347	Units w/ 16" (FBI) x 14" Bowls



7-PS-25 Shown With Optional Side Splashes

Removable Utility Tray for Side Splashes

- 8" X 3" X 2 5/16" Tray.
- Tray Holes Allow To Hang From Any Standard Side Splash.
- Perforated For Water Drainage.

7-PS-48 \$432 



Side Mounting Wall Brackets

Includes 2 brackets. Used for Added Strength & Support (Add to price of sink)

7-PS-36 \$195 



Tubular Wall Supports



Set of 2 Supports

Model #	Price	Description
7-PS-24	\$626	Units w/ 10"x14" Bowl & Splash Mt. Faucet
7-PS-24B	626	Units w/ 10"x14" Bowl & Deck Mt. Faucet
7-PS-24C	733	Units with 16"x14" & 16"x20" Bowls

MODS & ACCESSORIES

Hand Sink Modifications & Accessories

All Items On This Page Ship Via UPS

Instant Hot Water ON DEMAND

This unit allows for hand sinks to be installed in remote areas with just a cold water supply and available 30 amp electric power. There is no delay or wasted water while waiting for hot water to reach the faucet. Includes Heater & Plumbing Hardware.

7-PS-92 **\$2956**



Only 1 Single Supply Line Of Cold Water Is Required To Feed The Unit!

HANDSINK NOT INCLUDED

SOAP & TOWEL DISPENSERS



C-Fold Style Paper Towel & Soap Dispenser
Mounts On 17" Wide Hand Sinks Only.
7-PS-34 **\$1517**

Upgrade To Touchless Soap Dispenser, Add 7-PS-104 **\$441**
Plus 7-PS-130M17 (Product -\$49)



Wall Mounted Liquid Soap Dispenser
Mounting Hardware Included.
7-PS-12 **\$253**



Wall Mounted Touchless Liquid Soap Dispenser
Battery Powered (4 "AA" Batteries Required, Not Included).
Mounting Hardware Included.
Low Soap Indicator Window.
Low Battery Indicator Light.
7-PS-104 **\$441**



Wall Mounted Paper Towel Dispenser
Holds C-Fold Style Towels.
7-PS-35 **\$464**



Deck Mounted Liquid Soap Dispenser
K-12 **\$211**



Wall Mounted Stainless Steel Liquid Soap Dispenser
Mounting Hardware Included.
K-13 **\$575**

DRAINS, PARTS & P-TRAPS



3-1/2" Basket Drain Assembly
K-6 **\$64**



2" Drain Assembly w/ Strainer Plate
K-63 **\$54**



Drain Basket For K-6
K-310 **\$40**



Replacement Strainer Plates
for 3-1/2" Drain for 2" Drain
K-410 **\$34** K-411 **\$32**



Standard Chrome Plated P-Traps
22 Gauge
7-PS-14 **\$166**
17 Gauge
7-PS-10 **\$187**



Replacement Washers for 3-1/2" Drains
K-67F **\$20** (Set of 2)



K-26 \$224
Lever Drain with P-Trap & Overflow
K-67 \$224
Lever Drain Without Overflow

REPLACEMENT PARTS FOR K-26 DRAIN



Model #	Description	Price
K-67A	Tail Piece with Overflow Branch Only	\$39
K-67B	Overflow Hose with 2 Spring Clips	24
K-67C	Plastic 90° Overflow Head & Body	20
K-67D	Lever Handle for K-26 Drain	21
K-67E	Plastic Stopper (Includes "O" Ring)	20

MOP SINKS

Floor Mop Sinks

FLOOR UNITS Mounting Hardware Included

= Ships Via UPS
CUSTOM SIZES AVAILABLE

Model #	Bowl Size	Overall Dimension	Price	Approx. Wt.	Approx. Cu.
STANDARD MOP SINKS					
9-OP-20	16" x 20" x 6"	21" x 25"	\$2025	33 lbs.	4
9-OP-28	20" x 28" x 6"	25" x 33"	2621	47 lbs.	7
9-OP-40	16" x 20" x 12"	21" x 25"	2431	45 lbs.	6
9-OP-48	20" x 28" x 12"	25" x 33"	2867	62 lbs.	9
LARGE MOP SINK BOWL					
9-OP-44	24" x 24" x 12"	29" x 29"	3595	70 lbs.	9
9-OP-33	24" x 36" x 12"	29" x 41"	5476	80 lbs.	9
9-OP-34	24" x 24" x 12"	29" x 53"	6567	90 lbs.	9
DROP-FRONT MOP SINKS					
9-OP-40DF	16" x 20" x 12"	18 1/2" x 25"	3831	85 lbs.	9
9-OP-48DF	20" x 28" x 12"	22 1/2" x 33"	4263	110 lbs.	15

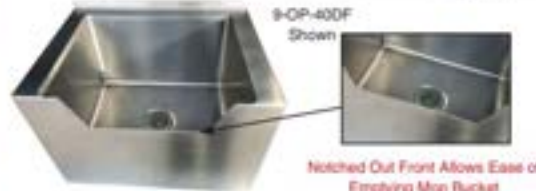

Convert Mop Sink In Cabinet To Drop Front. Add K-281 \$1180 (Not Offered On 9-Op-40 Or 9-Op-48 Or 6" Deep Mop Sinks)

Flush-Mount Floor Mop Sink

- Easy Mop Bucket Roll-In Design
- Standard Backsplash with Left & Right Splash, Left Splash or Right Splash Available
- 4" O.D. - 3" Long Plumbing Sleeve
- Front Anti-Splash Guard
- Removable Subway Grating
- Stainless Steel Strainer Basket with Handle

FT-2 \$85 ea.
 Replacement Stainless Steel Strainer Basket with Handle for Flush-Mount Floor Mop Sinks



WITH STAINLESS STEEL GRATES			WITH FIBERGLASS GRATES			Bowl Size	Overall Dimension	Splash Locations	Approx. Cu.
Model #	Approx. Wt.	Price	Model #	Approx. Wt.	Price				
9-OP-24FM-SSRL	128 lbs.	\$6469	9-OP-24FM-FGRL	96 lbs.	\$6469	21 3/8" x 22 x 10"	21 3/8" x 24"	Back, Left & Right	14
9-OP-24FM-SSL	120 lbs.	6249	9-OP-24FM-FGL	88 lbs.	6249	21 3/8" x 22 x 10"	21 3/8" x 24"	Back & Left	14
9-OP-24FM-SSR	120 lbs.	6249	9-OP-24FM-FGR	88 lbs.	6249	21 3/8" x 22 x 10"	21 3/8" x 24"	Back & Right	14

K-610 Removable Stainless Steel Grid \$1066

16" HIGH SIDE & BACK SPLASHES FOR FLOOR MOP SINKS

16 Gauge, 300 Series Stainless Steel

Splashes on All 3 Sides

Splash on Left or Right & Back

Model #	Fits Units:	Model #	Fits Units:	Price	Model #	Fits Units:	Model #	Fits Units:	Price
K-298	9-OP-20 9-OP-40	K-298D	9-OP-40DF	\$954	K-288LorR	9-OP-20 9-OP-40	K-288LorRD	9-OP-40DF	\$733
K-299	9-OP-28 9-OP-48	K-299D	9-OP-48DF	1026	K-290LorR	9-OP-28 9-OP-48	K-290LorRD	9-OP-48DF	800
K-300	9-OP-44	-	-	1210	K-291LorR	9-OP-44	-	-	866
K-303	9-OP-33	-	-	1284	K-293LorR	9-OP-33	-	-	910
K-304	9-OP-34	-	-	1377	K-294LorR	9-OP-34	-	-	975

Height Above Finished Floor (A.F.F.)

9-OP-20/9-OP-28 = 26" High 9-OP-40/9-OP-40DF/9-OP-44/9-OP-48/9-OP-48DF = 32" High



Wall Mounted Drainage Tray K-243 \$740

- Used with Floor Mounted Mop Sinks
- 16 Gauge, 300 Series Stainless Steel
- Includes 1/2" Drain & Plastic Hose
- 2" Tray Ht. with 6" Rear Splash (D.A.)
- 20" x 4" x 6". 13 lbs.



Hose & Hanger K-244 \$295



23" Mop Hanger K-242 \$321



STANDING SERVICE SINKS

Heavy Gauge Stainless Steel • 8" Bowl Depth • 8" High Backsplash • Stainless Steel Legs with Adjustable Bullet Feet
 • 8-OP-16 Includes Stainless Steel Cross-Bracing • 8" O.C. Faucet Holes • 3-1/2" Basket Drain

Model #	Bowl Size	Overall Dimension	Price	Approx. Wt.	Approx. Cu.
8-OP-16	16" x 20" x 8"	25" x 23"	\$2235	50 lbs.	13
4-OP-18	24" x 21" x 8"	24" x 25"	1526	50 lbs.	10

MOP SINKS

Mop Sink Cabinets

84" HIGH STAINLESS STEEL MOP SINK CABINETS

= Ships Via UPS



Single Width

- Single Left-Hinged Door*
- 1 Fixed Stainless Steel Mid-Shelf
- Ventilation Slots
- 2 Mop Holders
- Open Back For Plumbing
- 16 Ga., Type 304 S/S Mop Sink & Drain

16" x 20" x 12" Bowl
Overall Size: 22-5/8" x 25" x 84"



Double Width

- Hinged Double Doors
- Opening For Mop Bucket To Roll In
- 4 Fixed Stainless Steel Mid-Shelves (3 In Storage Side, 1 Above Sink)
- Enclosed Back Panel
- Ventilation Slots
- 2 Mop Holders
- Open Back For Plumbing
- 16 Ga., Type 304 S/S Mop Sink & Drain

16" x 20" x 12" Bowl
Overall Size: 22-5/8" x 50-1/4" x 84"

9-OPC-84DR Shown

Model #	Cabinet Material	Price	Approx. Wt.	Approx. Cu.
9-OPC-84	18 Ga., 430 S/S	\$10082	238 lbs.	40
9-OPC-84-300	18 Ga., 300 S/S	11712	238 lbs.	40

*Optional Right-Hand Door Swing Available - Add CAB-R N/C

Convert Mop Sink In Cabinet To Drop Front. Add K-261 \$958

Model #	Cabinet Material	Price	Approx. Wt.	Approx. Cu.
9-OPC-84DR	18 Ga., 430 S/S	\$13723	390 lbs.	72
9-OPC-84DL	18 Ga., 430 S/S	13723	390 lbs.	72
9-OPC-84DR-300	18 Ga., 300 S/S	14388	390 lbs.	72
9-OPC-84DL-300	18 Ga., 300 S/S	14388	390 lbs.	72

R And L Indicates Mop Sink Location.

Stainless Steel Cabinet with Floor



Sink Not Included

- Overall Size: 22-5/8" x 25" x 84"
- Single Left-Hinged Door*
- Fixed Stainless Steel Mid-Shelves
- Enclosed Back Panel
- Ventilation Slots On Both Sides

Model #	# of Fixed Shelves	Price	Approx. Wt.	Approx. Cu.
18 Ga. CAB-1	1	\$7361	200 lbs.	40
430 S/S CAB-4	4	8533	240 lbs.	40
18 Ga. CAB-1-300	1	8031	200 lbs.	40
300 S/S CAB-4-300	4	9368	240 lbs.	40

*Optional Right-Hand Door Swing Available - Add CAB-R N/C



CHEMICAL STORAGE CABINET

w/ 1 Fixed Stainless Steel Mid-Shelf



Vented Side Panels



WCH-15-24 Left Hinged (Shown Standard)

Overall Size: 15" x 24" x 32-1/2"

- Left-hinged Door*
- Vented Side Panels
- Wall Mounting Hardware Not Included

WCH-15-24 \$6191

18 Gauge, 430 Stainless Steel

WCH-15-24-300 \$6860

18 Gauge, 300 Stainless Steel

*Optional Right-Hand Door Swing Available - Add CAB-R N/C

MOP SINK CABINET ACCESSORIES & MODIFICATIONS

Service Faucet For Mop Sinks
8" O.C.
K-240* \$1286

*K-240 Does Not Meet Federal Lead Free Standards As it is Not Intended For Potable Water.

Double Cabinet Doors
Convert Single Width Cabinet to Double Doors
K-84-CAB \$987

Additional Fixed Mid-Shelf
K-94-SHELF \$521 ea.
For 84" High Cabinets
WC-SHELF \$125 lin. ft.
For Wall Cabinets

Cabinet Door Lock With Keys
SU-27 \$451
Required For Each Hinged Door

Service Faucet Vacuum Breaker Repair Kit
K-03 \$178

Add Rear Panel To Cabinet
K-94-BACK \$678
K-94-BACK-300 \$983
Add K-472 for 8" O.C. Faucet Holes \$143 Per Hole

S-Hook Mop Hanger
K-91 \$42 ea.

WARNING: Faucets on this page may expose you to chemicals, including lead, that are known to the State of California to cause cancer or birth defects or other reproductive harm. For more info, visit www.p66warnings.ca.gov

MULTI-STATIONS

NSF Multi-Stations



= Ships Via UPS

14 GAUGE, 304 STAINLESS STEEL SINKS WITH TUBULAR SUPPORTS OR LEGS

8" Bowl Depth • 8 1/2" High Backsplash • 8" O.C. Faucet Holes on Manual Operated, Single Holes on Knee or Electronic Operated • 3 1/2" Basket Drain(s)
 *F" Series Splash Mount Models Include K-159 3-1/2" Goosenecks. *F" Series Deck Mount Models Include K-134 8-1/2" Goosenecks.



L	NO FAUCETS INCLUDED		MANUAL FAUCETS INCLUDED		ELECTRONIC OPERATED FAUCETS		KNEE OPERATED FAUCETS		# of Faucets
	Splash Mount	Price	Splash Mount	Price	Splash Mount	Price	Splash Mount	Price	
40"	FS-WM-40'	\$5999	FS-WM-40-F	\$6725	FS-WM-40EF	\$9416	FS-WM-40KV	\$7856	2
60"	FS-WM-60'	6673	FS-WM-60-F	7762	FS-WM-60EF	11789	FS-WM-60KV	9449	3
80"	FS-WM-80'	7565	FS-WM-80-F	9016	FS-WM-80EF	14386	FS-WM-80KV	11266	4
100"	FS-WM-100'	8295	FS-WM-100-F	10112	FS-WM-100EF	16825	FS-WM-100KV	12925	5
120"	FS-WM-120'	10460	FS-WM-120-F	12638	FS-WM-120EF	20694	FS-WM-120KV	16014	6

14 GAUGE, 304 STAINLESS STEEL A.D.A. SINKS WITH TUBULAR SUPPORTS

5" Bowl Depth • 8 1/2" High Backsplash • 8" O.C. Faucet Holes on Manual Operated or Single Holes on Electronic Faucet Operated • Rear 3 1/2" Basket Drain(s).
 *F" Series Splash Mount Models Include K-161-LU 8" Goosenecks. *F" Series Deck Mount Models Include K-134 8-1/2" Goosenecks.

L	NO FAUCETS INCLUDED		MANUAL FAUCETS INCLUDED		ELECTRONIC OPERATED FAUCETS		# of Faucets
	Splash Mount	Price	Splash Mount	Price	Splash Mount	Price	
40"	FS-WM-40-ADA'	\$5999	FS-WM-40-ADA-F	\$6864	FS-WM-40EFADA	\$9233	2
60"	FS-WM-60-ADA'	6673	FS-WM-60-ADA-F	8037	FS-WM-60EFADA	11591	3
80"	FS-WM-80-ADA'	7565	FS-WM-80-ADA-F	9417	FS-WM-80EFADA	14159	4
100"	FS-WM-100-ADA'	8295	FS-WM-100-ADA-F	10649	FS-WM-100EFADA	16575	5
120"	FS-WM-120-ADA'	10460	FS-WM-120-ADA-F	13411	FS-WM-120EFADA	20523	6



*Add **K-472** For Faucet Hole Revision **\$176**

16 GAUGE, 304 STAINLESS STEEL SINKS WITH TUBULAR SUPPORTS OR LEGS

8" Bowl Depth • 8 1/2" High Backsplash • 8" O.C. Faucet Holes on Manual Operated, Single Holes on Knee or Electronic Operated • 3 1/2" Basket Drain(s).
 *F" Series Splash Mount Models Include K-159 3-1/2" Goosenecks. *F" Series Deck Mount Models Include K-134 8-1/2" Goosenecks.

L	NO FAUCETS INCLUDED		MANUAL FAUCETS INCLUDED		ELECTRONIC OPERATED FAUCETS		KNEE OPERATED FAUCETS		# of Faucets
	Splash Mount	Price	Splash Mount	Price	Splash Mount	Price	Splash Mount	Price	
40"	FC-WM-40'	\$5188	FC-WM-40-F	\$5914	FC-WM-40EF	\$8597	FC-WM-40KV	\$7040	2
60"	FC-WM-60'	5855	FC-WM-60-F	6948	FC-WM-60EF	10973	FC-WM-60KV	8633	3
80"	FC-WM-80'	6860	FC-WM-80-F	9417	FC-WM-80EF	13683	FC-WM-80KV	10564	4
100"	FC-WM-100'	7697	FC-WM-100-F	9514	FC-WM-100EF	16224	FC-WM-100KV	12324	5
120"	FC-WM-120'	9205	FC-WM-120-F	11384	FC-WM-120EF	19437	FC-WM-120KV	14758	6

16 GAUGE, 304 STAINLESS STEEL A.D.A. SINKS WITH TUBULAR SUPPORTS

5" Bowl Depth • 8 1/2" High Backsplash • 8" O.C. Faucet Holes on Manual Operated or Single Holes on Electronic Faucet Operated • Rear 3 1/2" Basket Drain(s).
 *F" Series Splash Mount Models Include K-161-LU 8" Goosenecks. *F" Series Deck Mount Models Include K-134 8-1/2" Goosenecks.

L	NO FAUCETS INCLUDED		MANUAL FAUCETS INCLUDED		ELECTRONIC OPERATED FAUCETS		# of Faucets
	Splash Mount	Price	Splash Mount	Price	Splash Mount	Price	
40"	FC-WM-40-ADA'	\$5188	FC-WM-40-ADA-F	\$6127	FC-WM-40EFADA	\$8543	2
60"	FC-WM-60-ADA'	5855	FC-WM-60-ADA-F	7250	FC-WM-60EFADA	10804	3
80"	FC-WM-80-ADA'	6860	FC-WM-80-ADA-F	8610	FC-WM-80EFADA	13347	4
100"	FC-WM-100-ADA'	7697	FC-WM-100-ADA-F	10131	FC-WM-100EFADA	16058	5
120"	FC-WM-120-ADA'	9205	FC-WM-120-ADA-F	12158	FC-WM-120EFADA	19269	6



*Add **K-472** For Faucet Hole Revision **\$176**

WARNING: Equipment that include faucets on this page may contain a chemical known to the State of California to cause cancer, birth defects or other reproductive harm.

= Ships Via UPS



SERVICE SINKS

NSF Service Sinks

14 GAUGE, 304 STAINLESS STEEL SERVICE SINKS WITH TUBULAR SUPPORTS OR LEGS

10" or 12" Bowl Depth • 8-1/2" High Backsplash • 8" O.C. Faucet Holes on Manual Operated, Single Holes on Knee or Electronic Operated • 3 1/2" Basket Drain(s).
 *F" Series Splash Mount Models Include K-159 3-1/2" Gooseneck. *F" Series Deck Mount Models Include K-134 8-1/2" Gooseneck.



NO FAUCET INCLUDED		MANUAL FAUCET INCLUDED		ELECTRONIC OPERATED FAUCET		KNEE OPERATED FAUCET		Bowl Depth	Overall Size	
Splash Mount	Price	Splash Mount	Price	Splash Mount	Price	Splash Mount	Price		L	W
FS-WM-2219*	\$3238	FS-WM-2219-F	\$3488	FS-WM-2219EF	\$4946	FS-WM-2219KV*	\$4165	10"	23"	23"
FS-WM-2721*	3447	FS-WM-2721-F	3685	FS-WM-2721EF	5151	FS-WM-2721KV*	4371	12"	27"	21 1/2"
FS-WM-3119*	3791	FS-WM-3119-F	4055	FS-WM-3119EF	5665	FS-WM-3119KV*	4809	12"	31"	23"

*Knee Valve Unit Has 8" Bowl Depth



14 GAUGE, 304 STAINLESS STEEL A.D.A. SERVICE SINKS WITH TUBULAR SUPPORTS

5" Bowl Depth • 8-1/2" High Backsplash • Stainless Steel Tubular Supports • 8" O.C. Faucet Holes on Manual Operated, Single Hole on Electronic Operated • 3 1/2" Basket Drain.
 *F" Series Splash Mount Models Include K-161-LU 6" Gooseneck. *F" Series Deck Mount Models Include K-134 8-1/2" Gooseneck.

NO FAUCET INCLUDED		MANUAL FAUCET INCLUDED		ELECTRONIC OPERATED FAUCET		Bowl Depth	Overall Size	
Splash Mount	Price	Splash Mount	Price	Splash Mount	Price		L	W
FS-WM-1-ADA*	\$5363	FS-WM-1-ADA-F*	\$5602	FS-WM-1-EFADA	\$7068	5"	40"	19-1/2"

*Add K-472 For Faucet Hole Revision \$176



16 GAUGE, 304 STAINLESS STEEL SERVICE SINKS WITH TUBULAR SUPPORTS OR LEGS

10" or 12" Bowl Depth • 8-1/2" High Backsplash • 8" O.C. Faucet Holes on Manual Operated, Single Holes on Knee or Electronic Operated • 3 1/2" Basket Drain(s).
 *F" Series Splash Mount Models Include K-159 3-1/2" Gooseneck. *F" Series Deck Mount Models Include K-134 8-1/2" Gooseneck.



NO FAUCET INCLUDED		MANUAL FAUCET INCLUDED		ELECTRONIC OPERATED FAUCET		KNEE OPERATED FAUCET		Bowl Depth	Overall Size	
Splash Mount	Price	Splash Mount	Price	Splash Mount	Price	Splash Mount	Price		L	W
FC-WM-2219*	\$2875	FC-WM-2219-F	\$3297	FC-WM-2219EF	\$4582	FC-WM-2219KV*	\$3805	10"	23"	23"
FC-WM-2721*	3028	FC-WM-2721-F	3451	FC-WM-2721EF	4733	FC-WM-2721KV*	3953	12"	27"	21 1/2"
FC-WM-3119*	3337	FC-WM-3119-F	3799	FC-WM-3119EF	5206	FC-WM-3119KV*	4351	12"	31"	23"

*Knee Valve Unit Has 8" Bowl Depth



16 GAUGE, 304 STAINLESS STEEL A.D.A. SERVICE SINKS WITH TUBULAR SUPPORTS

5" Bowl Depth • 8-1/2" High Backsplash • Stainless Steel Tubular Supports • 8" O.C. Faucet Holes on Manual Operated, Single Hole on Electronic Operated • 3 1/2" Basket Drain.
 *F" Series Splash Mount Models Include K-161-LU 6" Gooseneck. *F" Series Deck Mount Models Include K-134 8-1/2" Gooseneck.

NO FAUCET INCLUDED		MANUAL FAUCET INCLUDED		ELECTRONIC OPERATED FAUCET		Bowl Depth	Overall Size	
Splash Mount	Price	Splash Mount	Price	Splash Mount	Price		L	W
FC-WM-1-ADA*	\$5085	FC-WM-1-ADA-F	\$5484	FC-WM-1-EFADA	\$6794	5"	40"	19-1/2"

*Add K-472 For Faucet Hole Revision \$176



WARNING: Equipment that include faucets on this page may contain a chemical known to the State of California to cause cancer, birth defects or other reproductive harm.

MULTI-STATIONS

Square Corner Multi-Stations

 = Ships Via UPS

16 GAUGE, 304 STAINLESS STEEL MULTI-STATIONS WITH TUBULAR SUPPORTS OR LEGS

8" Bowl Depth • 8 1/2" High Backsplash • 8" O.C. Faucet Holes on Manual Operated, Single Holes on Knee or Electronic Operated • 3 1/2" Basket Drain(s)



L	NO FAUCETS INCLUDED		MANUAL FAUCETS INCLUDED		ELECTRONIC OPERATED FAUCETS		KNEE OPERATED FAUCETS		# of Faucets	Wt. lbs.	Cu. Ft.
	Model #	Price	Model #	Price	Model #	Price	Model #	Price			
23"	19-18-23	\$2606	19-18-23-F	\$2967	19-18-23EF	\$4406	19-18-23KV	\$3628	1	50 lbs.	10
40"	19-18-40	4187	19-18-40-F	4914	19-18-40EF	7597	19-18-40KV	6037	2	60 lbs.	15
60"	19-18-60	4946	19-18-60-F	6035	19-18-60EF	10062	19-18-60KV	7722	3	70 lbs.	18
80"	19-18-80	5514	19-18-80-F	6969	19-18-80EF	12338	19-18-80KV	9217	4	90 lbs.	22
100"	19-18-100	6276	19-18-100-F	8092	19-18-100EF	14804	19-18-100KV	10904	5	120 lbs.	30
120"	19-18-120	7850	19-18-120-F	10029	19-18-120EF	18082	19-18-120KV	13402	6	155 lbs.	36

*Add **K-472** For Faucet Hole Revision **\$176**



16 GAUGE, 304 STAINLESS STEEL A.D.A. MULTI-STATIONS WITH TUBULAR SUPPORTS

5" Bowl Depth • 8 1/2" High Backsplash • 8" O.C. Faucet Holes on Manual Operated or Single Holes on Electronic Faucet Operated • Rear 3 1/2" Basket Drain(s)



L	NO FAUCETS INCLUDED		MANUAL FAUCETS INCLUDED		ELECTRONIC OPERATED FAUCETS		# of Faucets	Wt. lbs.	Cu. Ft.
	Model #	Price	Model #	Price	Model #	Price			
40"	19-18-40-ADA	\$4187	19-18-40-ADA-F	\$5226	19-18-40EFADA	\$7597	2	60 lbs.	15
60"	19-18-60-ADA	4946	19-18-60-ADA-F	6505	19-18-60EFADA	10062	3	70 lbs.	18
80"	19-18-80-ADA	5514	19-18-80-ADA-F	7597	19-18-80EFADA	12338	4	100 lbs.	22
100"	19-18-100-ADA	6276	19-18-100-ADA-F	8877	19-18-100EFADA	14804	5	130 lbs.	30
120"	19-18-120-ADA	7850	19-18-120-ADA-F	10969	19-18-120EFADA	18082	6	165 lbs.	36

*Add **K-472** For Faucet Hole Revision **\$176**

WARNING: Equipment that includes a faucet may expose you to chemicals, including lead, that are known to the State of California to cause cancer or birth defects or other reproductive harm. For more info, visit www.p66warnings.ca.gov

SERVICE SINKS

Square Corner Service Sinks

16 GAUGE, 304 STAINLESS STEEL SERVICE SINKS WITH TUBULAR SUPPORTS OR LEGS

12" Bowl Depth (Excludes Knee Valve Units) • 8 1/2" High Backsplash • 8" O.C. Faucet Holes on Manual Operated, Single Holes on Knee or Electronic Operated • 3 1/2" Basket Drain(s)



NO FAUCET INCLUDED		MANUAL FAUCET INCLUDED		ELECTRONIC OPERATED FAUCETS		KNEE OPERATED FAUCETS		L	W	Wt.	Cu. Ft.
Model #	Price	Model #	Price	Model #	Price	Model #	Price				
WSS-14-21*	\$2739	WSS-14-21-F	\$3103	WSS-14-21EF	\$4444	WSS-14-21KV*	\$3665	18"	17 1/2"	45 lbs.	8
WSS-16-25*	3025	WSS-16-25-F	3388	WSS-16-25EF	4730	WSS-16-25KV*	3951	22"	19 1/2"	52 lbs.	10
WSS-16-31*	3326	WSS-16-31-F	3727	WSS-16-31EF	5206	WSS-16-31KV*	4347	31"	19 1/2"	75 lbs.	14

*Add **K-472** For Faucet Hole Revision **\$176**

*Knee Valve Unit Has 8" Bowl Depth



16 GAUGE, 304 STAINLESS STEEL A.D.A. SERVICE SINKS WITH TUBULAR SUPPORTS

5" Bowl Depth • 8 1/2" High Backsplash • 8" O.C. Faucet Holes on Manual Operated, Single Holes on Electronic Operated • Near 3 1/2" Basket Drain



NO FAUCET INCLUDED		MANUAL FAUCET INCLUDED		ELECTRONIC OPERATED FAUCETS		L	W	Wt.	Cu. Ft.
Model #	Price	Model #	Price	Model #	Price				
19-18-1-ADA*	\$4182	19-18-1-ADA-F	\$4703	19-18-1-EFADA	\$5807	40"	19 1/2"	60 lbs.	15

*Add **K-472** For Faucet Hole Revision **\$176**

MULTI-STATION HAND SINK ACCESSORIES & MODIFICATIONS



Model	Description	Price	Model	Description	Price
K-6	3 1/2" Drain (1 1/2" I.P.S.)	\$64 ea.	K-111B	H.D. 8" Splash Mounted Faucet	\$36 ea.
K-13	Stainless Steel Soap Dispenser	\$75 ea.	K-316-LU	Wrist Handles	167 pair
K-101	8" Swing Spout Splash Mt. Faucet	316 ea.	K-472	Faucet Hole Revision (Manual Faucet Operated Sinks Only)	176
K-121	Single Hole, Splash Mounted 3-1/2" Gooseneck Spout	197 ea.		Reduce rear splash on ADA multi-station hand sink or service sink to 5" tall (top of splash 39" AFF if installed at ADA working height, allows ADA compliant mirror (by others) to be mounted over sink)	N/C
K-134	H.D. Deck Mounted 8-1/2" Gooseneck Faucet (8" O.C.)	861 ea.	K-449		
K-159	H.D. Splash Mounted 3-1/2" Gooseneck Faucet (8" O.C.)	627 ea.	K-508	Special Sizing Change (Larger Size Cut Down To Smaller Size)	N/C
K-161-LU	H.D. Splash Mounted 8" Gooseneck Faucet (8" O.C.) With Wrist Handles	699 ea.	TA-19	Adjustable Stainless Steel Flanged Bullet Foot	81 ea.
K-411	Strainer Plate for 3-1/2" Drain	32 ea.			

WARNING: Equipment that includes a faucet may expose you to chemicals, including lead, that are known to the State of California to cause cancer or birth defects or other reproductive harm. For more info, visit www.p66warnings.ca.gov

MULTI-STATIONS

NSF Multi-Stations



= Ships Via UPS

14 GA., 304 STAINLESS STEEL SINKS W/STAINLESS STEEL LEGS & FLANGED FEET

8" Bowl Depth • 8 1/2" High Backsplash • 8" O.C. Faucet Holes on Manual Operated, Single Holes on Knee/Toe-Push or Electronic Operated
 • Stainless Steel Flanged Feet • Wall Support Bracket • Side & Rear Cross-Bracing • 3 1/2" Basket Drain(s)
 *F Series Splash Mount Models Include K-159 3-1/2" Goosenecks. *F Series Deck Mount Models Include K-134 8-1/2" Goosenecks.



L	NO FAUCETS INCLUDED		MANUAL FAUCETS INCLUDED		ELECTRONIC OPERATED FAUCETS		KNEE OPERATED FAUCETS		TOE-PUSH OPERATED FAUCETS		# of Faucets
	Splash Mount	Price	Splash Mount	Price	Splash Mount	Price	Splash Mount	Price	Splash Mount	Price	
40"	FS-FM-40'	\$6609	FS-FM-40-F	\$7335	FS-FM-40EF	\$10027	FS-FM-40KV	\$8466	FS-FM-40FV	\$8928	2
60"	FS-FM-60'	7432	FS-FM-60-F	8523	FS-FM-60EF	12549	FS-FM-60KV	9921	FS-FM-60FV	10209	3
80"	FS-FM-80'	8477	FS-FM-80-F	9929	FS-FM-80EF	15299	FS-FM-80KV	11814	FS-FM-80FV	12179	4
100"	FS-FM-100'	9511	FS-FM-100-F	11328	FS-FM-100EF	18041	FS-FM-100KV	13776	FS-FM-100FV	14142	5
120"	FS-FM-120'	11982	FS-FM-120-F	14164	FS-FM-120EF	22217	FS-FM-120KV	16952	FS-FM-120FV	17537	6

14 GA., 304 STAINLESS STEEL A.D.A. SINKS W/STAINLESS STEEL LEGS & FLANGED FEET

8" Bowl Depth • 8 1/2" High Backsplash • 8" O.C. Faucet Holes on Manual Operated or Single Holes on Electronic Faucet Operated
 • Stainless Steel Flanged Feet • Wall Support Bracket • Rear Cross-Bracing • 3 1/2" Basket Drain(s)
 *F Series Splash Mount Models Include K-161-LU 8" Goosenecks. *F Series Deck Mount Models Include K-134 8-1/2" Goosenecks.

L	NO FAUCETS INCLUDED		MANUAL FAUCETS INCLUDED		ELECTRONIC OPERATED FAUCETS		# of Faucets
	Splash Mount	Price	Splash Mount	Price	Splash Mount	Price	
40"	FS-FM-40-ADA'	\$6609	FS-FM-40-ADA-F	\$7339	FS-FM-40EFADA	\$9711	2
60"	FS-FM-60-ADA'	7432	FS-FM-60-ADA-F	8644	FS-FM-60EFADA	12197	3
80"	FS-FM-80-ADA'	8477	FS-FM-80-ADA-F	10175	FS-FM-80EFADA	16239	4
100"	FS-FM-100-ADA'	9511	FS-FM-100-ADA-F	11712	FS-FM-100EFADA	17639	5
120"	FS-FM-120-ADA'	11982	FS-FM-120-ADA-F	14673	FS-FM-120EFADA	21786	6

*Add K-472 For Faucet Hole Revision \$176



16 GA., 304 STAINLESS STEEL SINKS WITH STAINLESS STEEL LEGS & FLANGED FEET

8" Bowl Depth • 8 1/2" High Backsplash • 8" O.C. Faucet Holes on Manual Operated, Single Holes on Knee/Toe-Push or Electronic Operated
 • Stainless Steel Flanged Feet • Wall Support Bracket • Side & Rear Cross-Bracing • 3 1/2" Basket Drain(s)
 *F Series Splash Mount Models Include K-159 3-1/2" Goosenecks. *F Series Deck Mount Models Include K-134 8-1/2" Goosenecks.

L	NO FAUCETS INCLUDED		MANUAL FAUCETS INCLUDED		ELECTRONIC OPERATED FAUCETS		KNEE OPERATED FAUCETS		TOE-PUSH OPERATED FAUCETS		# of Faucets
	Splash Mount	Price	Splash Mount	Price	Splash Mount	Price	Splash Mount	Price	Splash Mount	Price	
40"	FC-FM-40'	\$5798	FC-FM-40-F	\$6523	FC-FM-40EF	\$9208	FC-FM-40KV	\$7413	FC-FM-40FV	\$7648	2
60"	FC-FM-60'	6619	FC-FM-60-F	7708	FC-FM-60EF	11734	FC-FM-60KV	8910	FC-FM-60FV	9394	3
80"	FC-FM-80'	7773	FC-FM-80-F	9227	FC-FM-80EF	14596	FC-FM-80KV	10822	FC-FM-80FV	11477	4
100"	FC-FM-100'	8916	FC-FM-100-F	10732	FC-FM-100EF	17443	FC-FM-100KV	12570	FC-FM-100FV	13544	5
120"	FC-FM-120'	10727	FC-FM-120-F	12907	FC-FM-120EF	20962	FC-FM-120KV	14969	FC-FM-120FV	16282	6

16 GA., 304 STAINLESS STEEL A.D.A. SINKS W/STAINLESS STEEL LEGS & FLANGED FEET

8" Bowl Depth • 8 1/2" High Backsplash • 8" O.C. Faucet Holes on Manual Operated or Single Holes on Electronic Faucet Operated
 • Stainless Steel Flanged Feet • Wall Support Bracket • Rear Cross-Bracing • 3 1/2" Basket Drain(s)
 *F Series Splash Mount Models Include K-161-LU 8" Goosenecks. *F Series Deck Mount Models Include K-134 8-1/2" Goosenecks.

L	NO FAUCETS INCLUDED		MANUAL FAUCETS INCLUDED		ELECTRONIC OPERATED FAUCETS		# of Faucets
	Splash Mount	Price	Splash Mount	Price	Splash Mount	Price	
40"	FC-FM-40-ADA'	\$5798	FC-FM-40-ADA-F	\$6603	FC-FM-40EFADA	\$8974	2
60"	FC-FM-60-ADA'	6619	FC-FM-60-ADA-F	7857	FC-FM-60EFADA	11414	3
80"	FC-FM-80-ADA'	7773	FC-FM-80-ADA-F	9365	FC-FM-80EFADA	14106	4
100"	FC-FM-100-ADA'	8916	FC-FM-100-ADA-F	11197	FC-FM-100EFADA	17123	5
120"	FC-FM-120-ADA'	10727	FC-FM-120-ADA-F	13420	FC-FM-120EFADA	20532	6

*Add K-472 For Faucet Hole Revision \$176



WARNING: Equipment that include faucets on this page may contain a chemical known to the State of California to cause cancer, birth defects or other reproductive harm.

= Ships Via UPS



SERVICE SINKS

NSF Service Sinks

14 GA., 304 STAINLESS STEEL SERVICE SINKS W/STAINLESS STEEL LEGS & FLANGED FEET

10" or 12" Bowl Depth • 8-1/2" High Backsplash • 8" O.C. Faucet Holes on Manual Operated, Single Holes on Knee/Toe-Push or Electronic Operated
 • Stainless Steel Flanged Feet • Wall Support Bracket • Side & Rear Cross-Bracing • 3 1/2" Basket Drain(s)
 *F Series Splash Mount Models Include K-159 3-1/2" Gooseneck, *F Series Deck Mount Models Include K-134 8-1/2" Gooseneck.



FS-FM-2219 Shown



FS-FM-2219-F Shown



FS-FM-2219EF Shown



FS-FM-2219KV Shown



FS-FM-2219FV Shown

NO FAUCET INCLUDED		MANUAL FAUCETS INCLUDED		ELECTRONIC OPERATED FAUCETS		KNEE OPERATED FAUCETS		TOE-PUSH OPERATED FAUCETS		Bowl Depth	Overall Size	
Splash Mount	Price	Splash Mount	Price	Splash Mount	Price	Splash Mount	Price	Splash Mount	Price		L	W
FS-FM-2219 [†]	\$3840	FS-FM-2219-F	\$4261	FS-FM-2219EF	\$5545	FS-FM-2219KV*	\$4767	FS-FM-2219FV	\$5237	10"	23"	23"
FS-FM-2721 [†]	4046	FS-FM-2721-F	4467	FS-FM-2721EF	5751	FS-FM-2721KV*	4971	FS-FM-2721FV	5444	12"	27"	21 1/2"
FS-FM-3119 [†]	4450	FS-FM-3119-F	4916	FS-FM-3119EF	6327	FS-FM-3119KV*	5471	FS-FM-3119FV	5986	12"	31"	23"

*Knee Valve Unit Has 8" Bowl Depth

14 GA., 304 STAINLESS STEEL A.D.A. SERVICE SINKS W/STAINLESS STEEL LEGS & FLANGED FEET



5" Bowl Depth • 8-1/2" High Backsplash • 8" O.C. Faucet Holes on Manual Operated, Single Hole on Electronic Operated
 • Stainless Steel Flanged Feet • Wall Support Bracket • Rear Cross-Bracing • 3 1/2" Basket Drain(s).

*F Series Splash Mount Models Include K-161-LU 6" Gooseneck, *F Series Deck Mount Models Include K-134 8-1/2" Gooseneck.

NO FAUCET INCLUDED		MANUAL FAUCET INCLUDED		ELECTRONIC OPERATED FAUCET		Bowl Depth	Overall Size	
Splash Mount	Price	Deck Mount	Price	Splash Mount	Price		L	W
FS-FM-1-ADA [†]	\$5840	FS-FM-1-ADA-F	\$6361	FS-FM-1-EFADA	\$7545	5"	40"	19-1/2"

*Add K-472 For Faucet Hole Revision \$176



FS-FM-1-ADA Shown

16 GA., 304 STAINLESS STEEL SERVICE SINKS W/STAINLESS STEEL LEGS & FLANGED FEET

10" or 12" Bowl Depth • 8-1/2" High Backsplash • 8" O.C. Faucet Holes on Manual Operated, Single Holes on Knee/Toe-Push or Electronic Operated
 • Stainless Steel Flanged Feet • Wall Support Bracket • Side & Rear Cross-Bracing • 3 1/2" Basket Drain(s).
 Gooseneck Faucet Included On *F Series Sinks. Splash Mt. Models Include 3-1/2" Gooseneck, Deck Mt. Models Include 6" Gooseneck.



FC-FM-2219 Shown



FC-FM-2219-F Shown



FC-FM-2219EF Shown



FC-FM-2219KV Shown



FC-FM-2219FV Shown



Toe-Push Valve

NO FAUCET INCLUDED		MANUAL FAUCET INCLUDED		ELECTRONIC OPERATED FAUCET		KNEE OPERATED FAUCET		TOE-PUSH OPERATED FAUCETS		Bowl Depth	Overall Size	
Splash Mount	Price	Splash Mount	Price	Splash Mount	Price	Splash Mount	Price	Splash Mount	Price		L	W
FC-FM-2219 [†]	\$3478	FC-FM-2219-F	\$3900	FC-FM-2219EF	\$5182	FC-FM-2219KV*	\$4274	FC-FM-2219FV	\$4844	10"	23"	19 1/2"
FC-FM-2721 [†]	3630	FC-FM-2721-F	4052	FC-FM-2721EF	5333	FC-FM-2721KV*	4554	FC-FM-2721FV	5001	12"	27"	21 1/2"
FC-FM-3119 [†]	4450	FC-FM-3119-F	4458	FC-FM-3119EF	5009	FC-FM-3119KV*	5009	FC-FM-3119FV	5501	12"	31"	23"

*Knee Valve Unit Has 8" Bowl Depth

16 GA., 304 STAINLESS STEEL A.D.A. SERVICE SINKS W/STAINLESS STEEL LEGS & FLANGED FEET



5" Bowl Depth • 8-1/2" High Backsplash • 8" O.C. Faucet Holes on Manual Operated, Single Hole on Electronic Operated
 • Stainless Steel Flanged Feet • Wall Support Bracket • Rear Cross-Bracing • 3 1/2" Basket Drain(s).

*F Series Splash Mount Models Include K-161-LU 6" Gooseneck, *F Series Deck Mount Models Include K-134 8-1/2" Gooseneck.

NO FAUCET INCLUDED		MANUAL FAUCET INCLUDED		ELECTRONIC OPERATED FAUCET		Bowl Depth	Overall Size	
Splash Mount	Price	Splash Mount	Price	Model #	Price		L	W
FC-FM-1-ADA [†]	\$5564	FC-FM-1-ADA-F	\$6084	FC-FM-1-EFADA	\$7269	5"	40"	19 1/2"

*Add K-472 For Faucet Hole Revision \$176



FC-FM-1-EFADA Shown

WARNING: Equipment that include faucets on this page may contain a chemical known to the State of California to cause cancer, birth defects or other reproductive harm.

MULTI-STATIONS

Square Corner Multi-Stations

 = Ships Via UPS

16 GA., 304 STAINLESS STEEL MULTI-STATIONS w/STAINLESS STEEL LEGS & FLANGED FEET

8" Bowl Depth • 8 1/2" High Backsplash • 8" O.C. Faucet Holes on Manual Operated, Single Holes on Knee/Toe-Push or Electronic Operated
 • Stainless Steel Flanged Feet • Wall Support Bracket • Side & Rear Cross-Bracing • 3 1/2" Basket Drain(s)



L	NO FAUCETS INCLUDED		MANUAL FAUCETS INCLUDED		ELECTRONIC OPERATED FAUCETS		KNEE OPERATED FAUCETS		TOE-PUSH OPERATED FAUCETS		# of Faucets	Wt.	Cu. Ft.
	Model #	Price	Model #	Price	Model #	Price	Model #	Price	Model #	Price			
23"	19-FM-23 ¹	\$3204	19-FM-23-F	\$3568	19-FM-23EF	\$5008	19-FM-23KV	\$4099	19-FM-23FV	\$4227	1	50 lbs.	10
40"	19-FM-40 ¹	4795	19-FM-40-F	5521	19-FM-40EF	8205	19-FM-40KV	6411	19-FM-40FV	6645	2	60 lbs.	15
60"	19-FM-60 ¹	5705	19-FM-60-F	6796	19-FM-60EF	10822	19-FM-60KV	7999	19-FM-60FV	8481	3	70 lbs.	18
80"	19-FM-80 ¹	6273	19-FM-80-F	7726	19-FM-80EF	13248	19-FM-80KV	9477	19-FM-80FV	10130	4	90 lbs.	22
100"	19-FM-100 ¹	7492	19-FM-100-F	9309	19-FM-100EF	16020	19-FM-100KV	11147	19-FM-100FV	12122	5	120 lbs.	30
120"	19-FM-120 ¹	9372	19-FM-120-F	11552	19-FM-120EF	19608	19-FM-120KV	13614	19-FM-120FV	14929	6	155 lbs.	36

¹Add **K-472** For Faucet Hole Revision **\$176**

16 GAUGE, 304 STAINLESS STEEL A.D.A. MULTI-STATIONS WITH TUBULAR SUPPORTS



5" Bowl Depth • 8 1/2" High Backsplash • 8" O.C. Faucet Holes on Manual Operated or Single Holes on Electronic Faucet Operated
 • Stainless Steel Flanged Feet • Wall Support Bracket • Rear Cross-Bracing • 3 1/2" Basket Drain(s)



L	NO FAUCETS INCLUDED		MANUAL FAUCETS INCLUDED		ELECTRONIC OPERATED FAUCETS		# of Faucets	Wt.	Cu. Ft.
	Model #	Price	Model #	Price	Model #	Price			
40"	19-FM-40-ADA ¹	\$4795	19-FM-40-ADA-F	\$5789	19-FM-40EFADA	\$8072	2	60 lbs.	15
60"	19-FM-60-ADA ¹	5705	19-FM-60-ADA-F	7267	19-FM-60EFADA	10604	3	70 lbs.	18
80"	19-FM-80-ADA ¹	6273	19-FM-80-ADA-F	8509	19-FM-80EFADA	13097	4	100 lbs.	22
100"	19-FM-100-ADA ¹	7492	19-FM-100-ADA-F	10095	19-FM-100EFADA	15865	5	130 lbs.	30
120"	19-FM-120-ADA ¹	9372	19-FM-120-ADA-F	12495	19-FM-120EFADA	19344	6	165 lbs.	36

¹Add **K-472** For Faucet Hole Revision **\$176**

SERVICE SINKS

Square Corner Service Sinks

16 GAUGE, 304 STAINLESS STEEL SERVICE SINKS w/STAINLESS STEEL LEGS & FLANGED FEET

12" Bowl Depth (Excludes Knee Valve Units) • 8 1/2" High Backsplash • 8" O.C. Faucet Holes on Manual Operated, Single Holes on Knee/Toe-Push or Electronic Operated
 • Stainless Steel Flanged Feet • Wall Support Bracket • Side & Rear Cross-Bracing • 3 1/2" Basket Drain(s)



WSS-14-21-FM Shown WSS-14-21-FM-F Shown WSS-14-21EF-FM Shown WSS-14-21KV-FM Shown WSS-14-21FV-FM Shown

NO FAUCET INCLUDED		MANUAL FAUCET INCLUDED		ELECTRONIC OPERATED FAUCETS		KNEE OPERATED FAUCETS		TOE-PUSH OPERATED FAUCETS		L	W	Wt.	Cu. Ft.
Model #	Price	Model #	Price	Model #	Price	Model #	Price	Model #	Price				
WSS-14-21-FM*	\$3340	WSS-14-21-FM-F	\$3703	WSS-14-21EF-FM	\$5044	WSS-14-21KV-FM*	\$4135	WSS-14-21FV-FM	\$4265	18"	17-1/2"	45 lbs.	8
WSS-16-25-FM*	3626	WSS-16-25-FM-F	3988	WSS-16-25EF-FM	5331	WSS-16-25KV-FM*	4551	WSS-16-25FV-FM	5039	22"	19-1/2"	52 lbs.	10
WSS-16-31-FM*	3988	WSS-16-31-FM-F	4388	WSS-16-31EF-FM	5864	WSS-16-31KV-FM*	5008	WSS-16-31FV-FM	5544	31"	19-1/2"	58 lbs.	11

*Add **K-472** For Faucet Hole Revision **\$176**

*Knee Valve Unit Has 8" Bowl Depth

16 GAUGE, 304 STAINLESS STEEL A.D.A. SERVICE SINKS WITH TUBULAR SUPPORTS



5" Bowl Depth • 8 1/2" High Backsplash • 8" O.C. Faucet Holes on Manual Operated, Single Holes on Electronic Operated
 • Stainless Steel Flanged Feet • Wall Support Bracket • Rear Cross-Bracing • 3 1/2" Basket Drain(s)



19-FM-1-ADA Shown 19-FM-1-ADA-F Shown 19-FM-1-EFADA Shown

NO FAUCET INCLUDED		MANUAL FAUCET INCLUDED		ELECTRONIC OPERATED FAUCET		L	W	Wt.	Cu. Ft.
Model #	Price	Model #	Price	Model #	Price				
19-FM-1-ADA*	\$4659	19-FM-1-ADA-F*	\$5082	19-FM-1-EFADA	\$6283	40"	19 1/2"	60 lbs.	15

*Add **K-472** For Faucet Hole Revision **\$176**

MULTI-STATION HAND SINK ACCESSORIES & MODIFICATIONS



Model	Description	Price	Model	Description	Price
K-6	3 1/2" Drain (1 1/2" I.P.S.)	\$64 ea.	K-1118	Extra H.D. 8" Splash Mounted Faucet	\$12 ea.
K-13	Stainless Steel Soap Dispenser	\$75 ea.	K-316-LU	Whist Handles	161 pair
K-101	8" Swing Spout Splash Mt. Faucet	316 ea.	K-472	Faucet Hole Revision (Manual Faucet Operated Sinks Only)	176
K-121	Single Hole, Splash Mounted 3-1/2" Goose-neck Spout	197 ea.		Reduce rear splash on ADA multi-station hand sink or service sink to 5" tall (top of splash 30" AFF if installed at ADA working height, allows ADA compliant mirror (by others) to be mounted over sink)	N/C
K-134	Deck Mounted 8-1/2" Goose-neck Faucet (8" O.C.)	861 ea.	K-449	ADA compliant mirror (by others) to be mounted over sink	N/C
K-159	Splash Mounted 3-1/2" Goose-neck Faucet (8" O.C.)	627 ea.	K-508	Special Sizing Charge (Larger Size Cut Down To Smaller Size)	N/C
K-161-LU	Splash Mounted 6" Goose-neck Faucet (8" O.C.) With Whist Handles	699 ea.	TA-19	Adjustable Stainless Steel Flanged Bullet Foot	78 ea.
K-411	Strainer Plate for 3-1/2" Drain	32 ea.			

WARNING: Equipment that includes a faucet may expose you to chemicals, including lead, that are known to the State of California to cause cancer or birth defects or other reproductive harm. For more info, visit www.p66warnings.ca.gov

REGALINE

Deep Drawn Sinks



Deep Drawn Bowls Are Seamless And Drawn Out of a Single Sheet of Steel

ALL MODELS INCLUDE STAINLESS STEEL LEGS & BULLET FEET

Now All Adjustable Cross Bracing!



94 Series



93 & 9 Series

- Features and Benefits**
- 3" Large Radius Corners
 - Easy to Clean
 - Satin Finish
 - No Welded Seams



<p>SPEC-LINE "94" Series</p> <ul style="list-style-type: none"> • 14 ga. 304 Stainless Steel • Stainless Steel Adjustable Cross Bracing On Front and Sides • 16 ga. 304 Stainless Steel Legs & Bullet Feet • 11" Backsplash • 14" Deep Sink Bowls <p>THE ONLY 14 GAUGE Deep Drawn SINK!</p>	<p>STANDARD "93" Series</p> <ul style="list-style-type: none"> • 16 ga. 304 Stainless Steel • Stainless Steel Adjustable Side Cross Bracing • Stainless Steel Legs and Bullet Feet • 8" Backsplash • 12" Deep Sink Bowls 	<p>SUPERSAVER "9" Series</p> <ul style="list-style-type: none"> • 18 ga. 304 Stainless Steel • Stainless Steel Adjustable Side Cross Bracing • Stainless Steel Legs and Bullet Feet • 8" Backsplash • 12" Deep Sink Bowls
--	--	---

ONE, TWO, THREE AND FOUR COMPARTMENTS with No Drainboards



94 Series Shown



Spec-Line 94 Series

Standard 93 Series

Super Saver 9 Series

14 Ga. 304 S/S 14" Water Level	16 Ga. 304 S/S 12" Water Level	18 Ga. 304 S/S 12" Water Level
-----------------------------------	-----------------------------------	-----------------------------------

Bowl Size	O.A. Length	# of Comp.	Model #	Price	Approx. Wt. (lbs.)	Model #	Price	Approx. Wt. (lbs.)	Model #	Price	Approx. Wt. (lbs.)	Cu. Ft.
16" x 20"	25"	One	94-1-24	\$5404	77	93-1-24	\$3512	62	9-1-24	\$3222	54	20
	44"	Two	94-2-36	7013	109	93-2-36	4815	76	9-2-36	4412	66	20
	62"	Three	94-3-54	8665	142	93-3-54	6096	107	9-3-54	5587	95	28
	81"	Four	94-4-72	11079	225	93-4-72	7882	176	9-4-72	7234	155	44
20" x 20"	29"	One	94-21-20	5904	92	93-21-20	3829	80	9-21-20	3771	61	20
	52"	Two	94-22-40	7700	118	93-22-40	5298	92	9-22-40	4858	79	23
	74"	Three	94-23-60	9911	232	93-23-60	7022	188	9-23-60	6435	169	44
	97"	Four	94-24-80	12458	285	93-24-80	8971	210	9-24-80	8250	192	56
18" x 24"	27"	One	94-61-18	6139	95	93-61-18	4116	84	9-61-18	3802	78	24
	48"	Two	94-62-36	7876	185	93-62-36	5545	144	9-62-36	5122	132	26
	68"	Three	94-63-54	10029	249	93-63-54	7217	203	9-63-54	6651	188	36
	89"	Four	94-64-72	12500	312	93-64-72	9110	264	9-64-72	8415	255	56
24" x 24"	33"	One	94-41-24	6325	97	93-41-24	4435	85	9-41-24	4070	80	23
	60"	Two	94-42-48	9151	174	93-42-48	6684	145	9-42-48	6130	133	31
	86"	Three	94-43-72	11529	252	93-43-72	8752	213	9-43-72	8028	200	56
	113"	Four	94-44-96	14330	347	93-44-96	11232	302	9-44-96	10292	281	74
20" x 28"	29"	One	94-81-20	6972	134	93-81-20	4616	94	9-81-20	4220	82	27
	52"	Two	94-82-40	9175	176	93-82-40	6779	150	9-82-40	6213	138	45
	74"	Three	94-83-60	11877	255	93-83-60	9052	225	9-83-60	8296	216	65
	97"	Four	94-84-80	15156	345	93-84-80	11703	310	9-84-80	10715	287	78



REGALINE

Deep Drawn Sinks



ONE COMPARTMENT WITH TWO DRAINBOARDS

Spec-Line 94 Series Standard 93 Series Super Saver 9 Series

Bowl Size	O.A. Length	DRBD. Size	14 Ga. 304 S/S 14" Water Level			16 Ga. 304 S/S 12" Water Level			18 Ga. 304 S/S 12" Water Level			Cu. Ft.
			Model #	Price	Approx. Wt. (lbs.)	Model #	Price	Approx. Wt. (lbs.)	Model #	Price	Approx. Wt. (lbs.)	
16" x 20"	54"	18"	94-1-24-18RL	\$5798	97	93-1-24-18RL	\$5042	82	9-1-24-18RL	\$4782	71	29
	66"	24"	94-1-24-24RL	6028	118	93-1-24-24RL	5204	95	9-1-24-24RL	4811	95	33
	90"	36"	94-1-24-36RL	6626	164	93-1-24-36RL	5583	134	9-1-24-36RL	5108	134	48
20" x 20"	58"	18"	94-21-20-18RL	6367	95	93-21-20-18RL	5523	78	9-21-20-18RL	5023	78	26
	70"	24"	94-21-20-24RL	6569	117	93-21-20-24RL	5574	82	9-21-20-24RL	5133	82	34
	94"	36"	94-21-20-36RL	7451	168	93-21-20-36RL	5917	147	9-21-20-36RL	5705	147	50
18" x 24"	58"	18"	94-61-18-18RL	6585	160	93-61-18-18RL	5764	138	9-61-18-18RL	5278	138	29
	68"	24"	94-61-18-24RL	6783	179	93-61-18-24RL	5815	150	9-61-18-24RL	5387	150	43
	92"	36"	94-61-18-36RL	7631	210	93-61-18-36RL	6150	180	9-61-18-36RL	5948	180	67
24" x 24"	74"	24"	94-41-24-24RL	7615	213	93-41-24-24RL	6768	185	9-41-24-24RL	6283	185	48
	98"	36"	94-41-24-36RL	8918	252	93-41-24-36RL	7033	210	9-41-24-36RL	6571	210	64
20" x 28"	58"	18"	94-81-20-18RL	7539	173	93-81-20-18RL	6830	150	9-81-20-18RL	6357	150	46
	70"	24"	94-81-20-24RL	7745	186	93-81-20-24RL	7033	165	9-81-20-24RL	6565	165	55
	94"	36"	94-81-20-36RL	9746	225	93-81-20-36RL	7249	195	9-81-20-36RL	6733	195	73

Weights and Cubes are approximate



ONE COMPARTMENT WITH ONE DRAINBOARD

Spec-Line 94 Series Standard 93 Series Super Saver 9 Series

Bowl Size	O.A. Length	DRBD. Size	14 Ga. 304 S/S 14" Water Level			16 Ga. 304 S/S 12" Water Level			18 Ga. 304 S/S 12" Water Level			Cu. Ft.
			Model #	Price	Approx. Wt. (lbs.)	Model #	Price	Approx. Wt. (lbs.)	Model #	Price	Approx. Wt. (lbs.)	
16" x 20"	40"	18"	94-1-24-18RorL	\$5579	93	93-1-24-18RorL	\$4816	84	9-1-24-18RorL	\$4518	65	20
	46"	24"	94-1-24-24RorL	5676	98	93-1-24-24RorL	4875	90	9-1-24-24RorL	4563	73	24
	58"	36"	94-1-24-36RorL	6186	114	93-1-24-36RorL	5388	101	9-1-24-36RorL	4969	78	26
20" x 20"	44"	18"	94-21-20-18RorL	6127	98	93-21-20-18RorL	5337	90	9-21-20-18RorL	4846	71	20
	50"	24"	94-21-20-24RorL	6222	104	93-21-20-24RorL	5378	96	9-21-20-24RorL	4896	77	23
	62"	36"	94-21-20-36RorL	6971	127	93-21-20-36RorL	5533	120	9-21-20-36RorL	5012	91	31
18" x 24"	42"	18"	94-61-18-18RorL	6343	100	93-61-18-18RorL	5581	94	9-61-18-18RorL	5108	75	24
	48"	24"	94-61-18-24RorL	6445	106	93-61-18-24RorL	5623	103	9-61-18-24RorL	5152	84	27
	60"	36"	94-61-18-36RorL	7172	130	93-61-18-36RorL	5770	122	9-61-18-36RorL	5262	95	38
24" x 24"	54"	24"	94-41-24-24RorL	7270	126	93-41-24-24RorL	6469	118	9-41-24-24RorL	5904	92	28
	66"	36"	94-41-24-36RorL	8395	149	93-41-24-36RorL	6613	141	9-41-24-36RorL	6059	110	42
20" x 28"	44"	18"	94-81-20-18RorL	7116	139	93-81-20-18RorL	6520	130	9-81-20-18RorL	5982	107	36
	50"	24"	94-81-20-24RorL	7237	146	93-81-20-24RorL	6645	137	9-81-20-24RorL	6097	113	40
	62"	36"	94-81-20-36RorL	9137	170	93-81-20-36RorL	6772	159	9-81-20-36RorL	6246	133	54

Weights and Cubes are approximate

See pages 35 and 36 for faucets, accessories, and modifications.



REGALINE

Deep Drawn Sinks



TWO COMPARTMENTS WITH TWO DRAINBOARDS

Spec-Line 94 Series

Standard 93 Series

Super Saver 9 Series

14 Ga. 304 S/S 14" Water Level	16 Ga. 304 S/S 12" Water Level	18 Ga. 304 S/S 12" Water Level
-----------------------------------	-----------------------------------	-----------------------------------

Bowl Size	O.A.		Model #	Price	Approx. Wt. (lbs.)	O.A.		Model #	Price	Approx. Wt. (lbs.)	Cu. Ft.	
	Length	DRBD. Size				Length	DRBD. Size					
16" x 20"	72"	18"	94-2-36-18RL	\$7801	141	93-2-36-18RL	\$6621	118	9-2-36-18RL	\$6038	100	40
	85"	24"	94-2-36-24RL	7985	156	93-2-36-24RL	6742	130	9-2-36-24RL	6136	110	46
	108"	36"	94-2-36-36RL	8830	212	93-2-36-36RL	7619	169	9-2-36-36RL	6859	144	58
20" x 20"	81"	18"	94-22-40-18RL	8798	176	93-22-40-18RL	7484	147	9-22-40-18RL	6688	125	44
	93"	24"	94-22-40-24RL	8943	220	93-22-40-24RL	7569	184	9-22-40-24RL	6744	162	50
	117"	36"	94-22-40-36RL	9782	273	93-22-40-36RL	8031	237	9-22-40-36RL	7118	215	72
18" x 24"	77"	18"	94-62-36-18RL	8943	247	93-62-36-18RL	7671	206	9-62-36-18RL	6903	181	50
	89"	24"	94-62-36-24RL	9089	277	93-62-36-24RL	7750	241	9-62-36-24RL	6953	226	58
	113"	36"	94-62-36-36RL	9895	341	93-62-36-36RL	8191	297	9-62-36-36RL	7310	271	96
24" x 24"	101"	24"	94-42-48-24RL	10828	339	93-42-48-24RL	9581	295	9-42-48-24RL	8682	259	65
	125"	36"	94-42-48-36RL	11626	391	93-42-48-36RL	9921	339	9-42-48-36RL	9731	314	96
20" x 28"	81"	18"	94-82-40-18RL	10292	251	93-82-40-18RL	9999	219	9-82-40-18RL	9490	194	64
	93"	24"	94-82-40-24RL	10753	294	93-82-40-24RL	10216	253	9-82-40-24RL	9701	226	73
	117"	36"	94-82-40-36RL	11479	330	93-82-40-36RL	10419	287	9-82-40-36RL	9878	261	96

Weights and Cubes are approximate



TWO COMPARTMENTS WITH ONE DRAINBOARD

Spec-Line 94 Series

Standard 93 Series

Super Saver 9 Series

14 Ga. 304 S/S 14" Water Level	16 Ga. 304 S/S 12" Water Level	18 Ga. 304 S/S 12" Water Level
-----------------------------------	-----------------------------------	-----------------------------------

Bowl Size	O.A.		Model #	Price	Approx. Wt. (lbs.)	O.A.		Model #	Price	Approx. Wt. (lbs.)	Cu. Ft.	
	Length	DRBD. Size				Length	DRBD. Size					
16" x 20"	58"	18"	94-2-36-18RorL	\$7539	108	93-2-36-18RorL	\$6375	88	9-2-36-18RorL	\$5845	72	26
	64"	24"	94-2-36-24RorL	7671	115	93-2-36-24RorL	6471	96	9-2-36-24RorL	5910	80	34
	76"	36"	94-2-36-36RorL	8066	158	93-2-36-36RorL	6589	132	9-2-36-36RorL	5998	115	42
20" x 20"	66"	18"	94-22-40-18RorL	8528	118	93-22-40-18RorL	7260	96	9-22-40-18RorL	6508	83	30
	72"	24"	94-22-40-24RorL	8627	136	93-22-40-24RorL	7296	114	9-22-40-24RorL	6536	95	39
	84"	36"	94-22-40-36RorL	9097	163	93-22-40-36RorL	7415	140	9-22-40-36RorL	6625	123	46
18" x 24"	62"	18"	94-62-36-18RorL	8682	147	93-62-36-18RorL	7444	128	9-62-36-18RorL	6729	115	40
	68"	24"	94-62-36-24RorL	8779	160	93-62-36-24RorL	7484	139	9-62-36-24RorL	6753	126	44
	80"	36"	94-62-36-36RorL	9237	200	93-62-36-36RorL	7599	174	9-62-36-36RorL	6837	158	53
24" x 24"	80"	24"	94-42-48-24RorL	10382	229	93-42-48-24RorL	9188	194	9-42-48-24RorL	8386	172	53
	92"	36"	94-42-48-36RorL	11013	261	93-42-48-36RorL	9889	235	9-42-48-36RorL	9427	194	60
20" x 28"	66"	18"	94-82-40-18RorL	10218	213	93-82-40-18RorL	9786	183	9-82-40-18RorL	9192	167	60
	72"	24"	94-82-40-24RorL	10339	227	93-82-40-24RorL	9907	195	9-82-40-24RorL	9310	176	64
	84"	36"	94-82-40-36RorL	10907	266	93-82-40-36RorL	10229	227	9-82-40-36RorL	9387	207	76

Weights and Cubes are approximate

See pages 35 and 36 for faucets, accessories, and modifications.



REGALINE

Deep Drawn Sinks



THREE COMPARTMENTS WITH TWO DRAINBOARDS

Spec-Line 94 Series Standard 93 Series Super Saver 9 Series

14 Ga. 304 S/S 14" Water Level	16 Ga. 304 S/S 12" Water Level	18 Ga. 304 S/S 12" Water Level
-----------------------------------	-----------------------------------	-----------------------------------

Bowl Size	O.A. DRBD.		Model #	Price	Approx. Wt. (lbs.)	Model #	Price	Approx. Wt. (lbs.)	Model #	Price	Approx. Wt. (lbs.)	Cu. Ft.
	Length	Size										
16" x 20"	91"	18"	94-3-54-18RL	\$9249	230	93-3-54-18RL	\$7923	189	9-3-54-18RL	\$6119	182	49
	103"	24"	94-3-54-24RL	9444	248	93-3-54-24RL	8042	197	9-3-54-24RL	6222	190	55
	127"	36"	94-3-54-36RL	10355	275	93-3-54-36RL	8535	239	9-3-54-36RL	8042	208	96
20" x 20"	103"	18"	94-23-60-18RL	10896	248	93-23-60-18RL	9395	203	9-23-60-18RL	8427	198	59
	115"	24"	94-23-60-24RL	11215	276	93-23-60-24RL	9639	220	9-23-60-24RL	8633	195	85
	139"	36"	94-23-60-36RL	12096	408	93-23-60-36RL	9988	387	9-23-60-36RL	8910	364	89
18" x 24"	97"	18"	94-63-54-18RL	10979	323	93-63-54-18RL	9522	289	9-63-54-18RL	8586	226	62
	109"	24"	94-63-54-24RL	11294	334	93-63-54-24RL	9753	304	9-63-54-24RL	8790	233	85
	133"	36"	94-63-54-36RL	12143	418	93-63-54-36RL	10099	367	9-63-54-36RL	9048	325	96
24" x 24"	127"	24"	94-43-72-24RL	13382	390	93-43-72-24RL	12059	331	9-43-72-24RL	10936	318	98
	151"	36"	94-43-72-36RL	14356	448	93-43-72-36RL	12324	393	9-43-72-36RL	11656	345	110
20" x 28"	103"	18"	94-83-60-18RL	13542	358	93-83-60-18RL	12113	315	9-83-60-18RL	11538	277	83
	115"	24"	94-83-60-24RL	13737	394	93-83-60-24RL	12320	346	9-83-60-24RL	11736	305	95
	139"	36"	94-83-60-36RL	14768	451	93-83-60-36RL	12614	398	9-83-60-36RL	11938	350	109

* Requires Two Faucets

Weights and Cubes are approximate



THREE COMPARTMENTS WITH ONE DRAINBOARD

Spec-Line 94 Series Standard 93 Series Super Saver 9 Series

14 Ga. 304 S/S 14" Water Level	16 Ga. 304 S/S 12" Water Level	18 Ga. 304 S/S 12" Water Level
-----------------------------------	-----------------------------------	-----------------------------------

Bowl Size	O.A. DRBD.		Model #	Price	Approx. Wt. (lbs.)	Model #	Price	Approx. Wt. (lbs.)	Model #	Price	Approx. Wt. (lbs.)	Cu. Ft.
	Length	Size										
16" x 20"	77"	18"	94-3-54-18RorL	\$9029	214	93-3-54-18RorL	\$7711	173	9-3-54-18RorL	\$5914	167	42
	83"	24"	94-3-54-24RorL	9123	222	93-3-54-24RorL	7770	188	9-3-54-24RorL	5971	177	45
	95"	36"	94-3-54-36RorL	9642	243	93-3-54-36RorL	8287	220	9-3-54-36RorL	7476	190	51
20" x 20"	89"	18"	94-23-60-18RorL	10650	234	93-23-60-18RorL	9145	207	9-23-60-18RorL	8224	184	52
	95"	24"	94-23-60-24RorL	10722	245	93-23-60-24RorL	9185	205	9-23-60-24RorL	8250	193	55
	107"	36"	94-23-60-36RorL	11327	252	93-23-60-36RorL	9485	216	9-23-60-36RorL	8347	208	60
18" x 24"	83"	18"	94-63-54-18RorL	10746	296	93-63-54-18RorL	9274	271	9-63-54-18RorL	8386	255	54
	89"	24"	94-63-54-24RorL	10817	308	93-63-54-24RorL	9310	281	9-63-54-24RorL	8415	269	58
	101"	36"	94-63-54-36RorL	11400	318	93-63-54-36RorL	9610	300	9-63-54-36RorL	8503	287	65
24" x 24"	107"	24"	94-43-72-24RorL	13043	342	93-43-72-24RorL	11707	312	9-43-72-24RorL	10698	298	68
	119"	36"	94-43-72-36RorL	14097	365	93-43-72-36RorL	11806	339	9-43-72-36RorL	11353	320	96
20" x 28"	89"	18"	94-83-60-18RorL	13159	281	93-83-60-18RorL	11813	292	9-83-60-18RorL	11292	225	79
	95"	24"	94-83-60-24RorL	13275	296	93-83-60-24RorL	11931	273	9-83-60-24RorL	11404	268	86
	107"	36"	94-83-60-36RorL	13736	308	93-83-60-36RorL	12042	287	9-83-60-36RorL	11474	277	89

* Requires Two Faucets

Weights and Cubes are approximate

See pages 35 and 36 for faucets, accessories, and modifications.



REGALINE

Deep Drawn Sinks



FOUR COMPARTMENTS WITH TWO DRAINBOARDS

Spec-Line 94 Series Standard 93 Series Super Saver 9 Series

14 Ga. 304 S/S 14" Water Level 16 Ga. 304 S/S 12" Water Level 18 Ga. 304 S/S 12" Water Level

Bowl Size	O.A. Length	DRBD. Size	Model #	Price	Approx. Wt. (lbs.)	Model #	Price	Approx. Wt. (lbs.)	Model #	Price	Approx. Wt. (lbs.)	Cu. Ft.
16" x 20"	110"	18"	94-4-72-18RL	\$11581	210	93-4-72-18RL	\$9980	183	9-4-72-18RL	\$9258	175	58
	122"	24"	94-4-72-24RL	11796	275	93-4-72-24RL	10131	252	9-4-72-24RL	9383	241	64
	146"	36"	94-4-72-36RL	12659	313	93-4-72-36RL	10440	287	9-4-72-36RL	9936	274	86
20" x 20"	126"	18"	94-24-80-18RL	13510	293	93-24-80-18RL	11626	268	9-24-80-18RL	10440	259	87
	138"	24"	94-24-80-24RL	13647	312	93-24-80-24RL	11776	288	9-24-80-24RL	10533	275	95
	162"	36"	94-24-80-36RL	14627	351	93-24-80-36RL	12101	322	9-24-80-36RL	11079	308	111
18" x 24"	118"	18"	94-64-72-18RL	13517	358	93-64-72-18RL	11692	346	9-64-72-18RL	10536	336	82
	130"	24"	94-64-72-24RL	13648	372	93-64-72-24RL	11832	355	9-64-72-24RL	10634	344	90
	154"	36"	94-64-72-36RL	14597	409	93-64-72-36RL	12146	392	9-64-72-36RL	11162	378	106
24" x 24"	154"	24"	94-44-96-24RL	16125	395	93-44-96-24RL	15187	361	9-44-96-24RL	13449	348	100
	178"	36"	94-44-96-36RL	17283	431	93-44-96-36RL	15534	398	9-44-96-36RL	14622	382	122
20" x 28"	126"	18"	94-84-80-18RL	16389	382	93-84-80-18RL	15514	361	9-84-80-18RL	14647	350	97
	138"	24"	94-84-80-24RL	16598	402	93-84-80-24RL	15722	374	9-84-80-24RL	14852	361	106
	162"	36"	94-84-80-36RL	17832	442	93-84-80-36RL	16029	411	9-84-80-36RL	15027	395	124

ALL UNITS REQUIRE TWO FAUCETS

Weights and Cubes are approximate



FOUR COMPARTMENTS WITH ONE DRAINBOARD

Spec-Line 94 Series Standard 93 Series Super Saver 9 Series

14 Ga. 304 S/S 14" Water Level 16 Ga. 304 S/S 12" Water Level 18 Ga. 304 S/S 12" Water Level

Bowl Size	O.A. Length	DRBD. Size	Model #	Price	Approx. Wt. (lbs.)	Model #	Price	Approx. Wt. (lbs.)	Model #	Price	Approx. Wt. (lbs.)	Cu. Ft.
16" x 20"	96"	18"	94-4-72-18RorL	\$11166	202	93-4-72-18RorL	\$9585	165	9-4-72-18RorL	\$8911	158	52
	101"	24"	94-4-72-24RorL	11266	216	93-4-72-24RorL	9649	188	9-4-72-24RorL	8952	175	54
	113"	36"	94-4-72-36RorL	12065	260	93-4-72-36RorL	9951	238	9-4-72-36RorL	9519	227	60
20" x 20"	111"	18"	94-24-80-18RorL	13186	299	93-24-80-18RorL	11395	241	9-24-80-18RorL	9477	229	61
	117"	24"	94-24-80-24RorL	13258	320	93-24-80-24RorL	11433	250	9-24-80-24RorL	10292	239	62
	129"	36"	94-24-80-36RorL	14043	341	93-24-80-36RorL	11589	267	9-24-80-36RorL	10418	250	90
18" x 24"	103"	18"	94-64-72-18RorL	13202	339	93-64-72-18RorL	11465	329	9-64-72-18RorL	9778	318	72
	109"	24"	94-64-72-24RorL	13275	351	93-64-72-24RorL	11507	338	9-64-72-24RorL	10396	329	76
	121"	36"	94-64-72-36RorL	14036	389	93-64-72-36RorL	11660	353	9-64-72-36RorL	10511	341	84
24" x 24"	133"	24"	94-44-96-24RorL	15682	354	93-44-96-24RorL	14858	336	9-44-96-24RorL	13160	327	92
	145"	36"	94-44-96-36RorL	16215	376	93-44-96-36RorL	15041	355	9-44-96-36RorL	14178	344	100
20" x 28"	111"	18"	94-84-80-18RorL	16009	348	93-84-80-18RorL	15211	329	9-84-80-18RorL	14356	317	87
	117"	24"	94-84-80-24RorL	16127	364	93-84-80-24RorL	15326	337	9-84-80-24RorL	14478	329	91
	129"	36"	94-84-80-36RorL	17156	382	93-84-80-36RorL	15447	355	9-84-80-36RorL	14539	347	100

ALL UNITS REQUIRE TWO FAUCETS

Weights and Cubes are approximate

See pages 35 and 36 for faucets, accessories, and modifications.



SPECIALTY SINKS

Specialty Sinks

Corner Sinks

16 Gauge, 304 Stainless Steel

- Adjustable Cross-Bracing
- Stainless Steel Legs
- Stainless Steel Adjustable Bullet Feet



94-K3-11D Shown



OPTIONAL:

5/8" Thick Poly-Vance Cutting Boards Available
(See Grid For Proper Model)

Six Deep Drawn Combinations To Choose From!

Model #	Bowl Sizes	Wall Dim.	Drbd. Dim.	Price	Approx. Wt.	Approx. Cubes	Optional Poly-Vance Cutting Boards
94-K6-18D	1) 20" x 20" x 12" 2) 16" x 20" x 12"	61" x 61"	18"	\$10625	231 lbs.	71	K-2E \$413
94-K2-24D	3) 20" x 20" x 12"	71" x 71"	24"	10905	265 lbs.	99	K-2E 413
94-K4-24D	3) 24" x 24" x 12"	79" x 79"	24"	11630	338 lbs.	114	K-2F 413
94-K8-30D	1) 20" x 20" x 12" 2) 20" x 28" x 12"	86" x 86"	30"	12382	350 lbs.	131	K-2E 413
94-K3-11D	1) 14" x 14" x 12" 2) 14" x 16" x 12"	54" x 54"	17"	7281	215 lbs.	60	K-2H 413
94-K5-11D	1) 14" x 14" x 10" 2) 10" x 14" x 10"	42" x 42"	11"	7888	180 lbs.	37	K-2H 413

FABRICATED SPECIALTY SINKS

Convenience Store Sinks

Our Solution...to Your Limited Space Problem
In Six Feet or less... you can WASH, RINSE & SANITIZE

- 18 Gauge Stainless Steel
- Stainless Steel Legs
- Welded Cross Bracing
- Stainless Steel Adjustable Bullet Feet

All Sinks Feature
TWO Drainboards



Model #	Bowl Size	# of Comp.	Drbd. Size	O.A. Length	Price	Approx. Wt.	Approx. Cu.
K7-CS-21	10" x 14" x 10"	3	12"	58"	\$3891	85 lbs.	27
K7-CS-22	10" x 14" x 10"	3	18"	70"	4000	120 lbs.	39
K7-CS-29	14" x 18" x 12"	3	12"	70"	4261	138 lbs.	39
K7-CS-32	12" x 20" x 12"	3	12"	64"	4946	130 lbs.	35



Super Size Sinks 16 Gauge, 304 Stainless Steel

Model #	Bowl Size	# of Comp.	Drbd. Size	Overall Size L x W	Price	Approx. Wt.	Approx. Cu.
K7-3-1432-18RL*	14" x 32" x 12"	3	18"	78" x 36"	\$10359	290 lbs.	50
K7-3-2030-24RL	20" x 30" x 14"	3	24"	108" x 36"	14832	345 lbs.	78
K7-3-2430-24RL	24" x 30" x 14"	3	24"	120" x 36"	15420	380 lbs.	86
K7-3-3024-24RL	30" x 24" x 14"	3	24"	138" x 30"	15961	395 lbs.	84
K7-3-3030-24RL	30" x 30" x 14"	3	24"	138" x 36"	16717	420 lbs.	98

*12" Deep Bowls For 1/4 Gauge Units Add -14 At End Of Model Number & Add \$741 List.

- Fabricated Design
- 16 ga. 304 Series
- 14" Deep Bowls
- Tile Edge Splash
- Full Skirt Design
- Stainless Steel Legs
- Stainless Steel Adjustable Bullet Feet
- Space Saving - Reduced Overall Lengths

Meat & Platter Sink

16 Gauge, 304 Stainless Steel

- Two 18" Drainboards
- 91" x 35 1/2"
- Bowl Sizes:
 - 1 - 24" x 30" Bowl
 - 2 - 15" x 32" Bowls
- 351 lbs. 59 Cu. Ft.



18-K5-56 \$15661

Heavy Duty Extra Long Faucet

Required Faucet For Meat & Platter Sink

- Splash Mount
- 18" Swing Spout
- 8" O.C.
- T&S Equivalent: 58-8WLX18



K-211 \$784

Units Can Be Customized With Modifications & Accessories!
See Pages 35 & 36. Other Sizes Available. Call For Pricing.

WARNING: Faucets on this page may expose you to chemicals, including lead, that are known to the State of California to cause cancer or birth defects or other reproductive harm. For more info, visit www.p66warnings.ca.gov

FABRICATED

FC Series Fabricated Sinks

16 GAUGE FABRICATED SINKS

- 16 Ga. 304 Stainless Steel
- 14" Deep Bowls
- All Welded Super-Sturdy Cross-Bracing
- Tile Edge Splash
- Stainless Steel Legs
- Adjustable Stainless Steel Bullet Feet

SUPER STURDY
CROSS BRACING



ONE COMPARTMENT SINKS

Bowl Size	Model #	O.A. Length	O.A. Width	Price	Wt.	Cu.
16" x 20"	FC-1-1620	21"	26"	\$2082	49	12
	FC-1-1620-18RorL	36.5"	26"	2779	65	18
	FC-1-1620-18RL	52"	26"	2869	80	25
18" x 18"	FC-1-1818	23"	24"	2035	50	13
	FC-1-1818-18RorL	38.5"	24"	2698	60	22
	FC-1-1818-18RL	54"	24"	2748	72	24
	FC-1-1818-24RorL	45"	24"	3088	66	17
	FC-1-1818-24RL	66"	24"	3191	85	28
	FC-1-1824	23"	30"	2364	63	16
18" x 24"	FC-1-1824-18RorL	38.5"	30"	2990	130	25
	FC-1-1824-24RorL	45"	30"	3146	139	28
	FC-1-1824-18RL	54"	30"	3089	170	34
	FC-1-1824-24RL	66"	30"	3203	175	40
24" x 24"	FC-1-2424	29"	30"	2514	68	16
	FC-1-2424-18RorL	44.5"	30"	3179	95	28
	FC-1-2424-24RorL	50.5"	30"	3445	146	34
	FC-1-2424-18RL	60"	30"	3374	175	37
	FC-1-2424-24RL	72"	30"	3556	196	44
30" x 24"	FC-1-3024	35"	30"	4608	80	20
	FC-1-3024-24RorL	56.5"	30"	4991	180	41
	FC-1-3024-24RL	78"	30"	5462	225	50
36" x 24"	FC-1-3624	41"	30"	5462	200	28
	FC-1-3624-24RorL	62.5"	30"	5695	225	48
	FC-1-3624-24RL	84"	30"	7792	250	59
48" x 24"	FC-1-4824-24RL	96"	30"	8206	290	56

Additional Sizes Available.

See Modifications & Accessories on Pages 35 & 36



TWO COMPARTMENT SINKS

Bowl Size	Model #	O.A. Length	O.A. Width	Price	Wt.	Cu.
15" x 15"	FC-2-1515	35"	21"	\$3235	57	19
16" x 20"	FC-2-1620	37"	26"	3724	60	18
	FC-2-1620-18RorL	52.5"	26"	4362	62	25
	FC-2-1620-18RL	68"	26"	4485	101	30
18" x 18"	FC-2-1818	41"	24"	3504	66	23
	FC-2-1818-18RorL	56.5"	24"	4056	89	26
	FC-2-1818-18RL	72"	24"	4294	183	41
	FC-2-1818-24RL	84"	24"	4612	200	30
18" x 24"	FC-2-1824	41"	30"	3765	181	26
	FC-2-1824-18RorL	56.5"	30"	4278	185	37
	FC-2-1824-24RorL	62.5"	30"	4677	200	39
	FC-2-1824-18RL	72"	30"	4808	210	44
20" x 30"	FC-2-1824-24RL	84"	30"	5025	230	51
	FC-2-2030-18RorL	60.5"	30"	7097	195	42
	FC-2-2030-18RL	76"	30"	7245	250	47
24" x 24"	FC-2-2030-24RorL	66.5"	30"	7434	250	45
	FC-2-2030-24RL	88"	30"	7604	285	56
	FC-2-2424	53"	30"	4105	181	33
	FC-2-2424-18RorL	68.5"	30"	5031	233	42
24" x 24"	FC-2-2424-24RorL	74.5"	30"	5220	240	46
	FC-2-2424-18RL	84"	30"	5119	245	53
	FC-2-2424-24RL	96"	30"	5352	255	60

Fabricated Corner Sink

16 Gauge, 304 Stainless Steel

FC-K6-18D \$7655



- Welded Cross-Bracing
- S/S Legs & Bullet Feet
- Requires 2 Faucets (Not Included)
- 3 - 18" x 18" x 14" Bowls
- 2 - 18" x 18" Drainboards
- Wall Dimension: 57" x 57"
- 248 Lbs. 66 Cu. Ft.



FABRICATED

FC Series Fabricated Sinks

16 GAUGE FABRICATED SINKS

- 16 Ga. 304 Stainless Steel
- 14" Deep Bowls
- All Welded Super-Sturdy Cross-Bracing
- Tile Edge Splash
- Stainless Steel Legs
- Adjustable Stainless Steel Bullet Feet

THREE COMPARTMENT SINKS

Bowl Size	Model #	O.A. Length	O.A. Width	Price	Wt.	Cu.
15" x 15"	FC-3-1515	50"	21"	\$3697	85	25
	FC-3-1515-15RorL	62.5"	21"	3966	98	31
	FC-3-1515-15RL	75"	21"	4074	120	42
15" x 24"	FC-3-1524	50"	30"	4805	180	34
	FC-3-1524-24RorL	71.5"	30"	4928	210	58
	FC-3-1524-24RL	93"	30"	5174	255	52
16" x 20"	FC-3-1620	53"	26"	4089	120	25
	FC-3-1620-18RorL	68.5"	26"	4370	225	32
	FC-3-1620-18RL	84"	26"	4613	235	38
	FC-3-1620-24RL	96"	26"	4938	263	49
16" x 20"	FC-3-1620-36RL	120"	26"	5646	300	54
	FC-3-1818	59"	24"	3941	135	25
	FC-3-1818-18RorL	74.5"	24"	4190	235	31
	FC-3-1818-24RorL	80.5"	24"	4324	250	34
18" x 18"	FC-3-1818-18RL	90"	24"	4733	245	47
	FC-3-1818-24RL	102"	24"	4662	265	53
	FC-3-1824	59"	30"	4213	182	36
18" x 24"	FC-3-1824-18RorL	74.5"	30"	4743	220	61
	FC-3-1824-24RorL	80.5"	30"	4946	230	49
	FC-3-1824-18RL	90"	30"	5310	265	56
	FC-3-1824-24RL	102"	30"	5574	270	63
	FC-3-2424	79"	30"	4895	243	47
24" x 24"	FC-3-2424-18RorL	92.5"	30"	5800	260	56
	FC-3-2424-24RorL	98.5"	30"	6047	281	67
	FC-3-2424-18RL	108"	30"	5990	295	64
	FC-3-2424-24RL	120"	30"	6172	315	68
20" x 28"	FC-3-2028-24RL	108"	34"	7158	310	62
20" x 30"	FC-3-2030-20RL	100"	36"	6530	318	58
	FC-3-2030-24RL	108"	36"	7247	330	64
	FC-3-2030-30RL	150"	36"	7702	345	70
24" x 30"	FC-3-2430	77"	36"	5297	225	38
	FC-3-2430-24RorL	99"	36"	6164	310	59
	FC-3-2430-24RL	120"	36"	9138	345	81
	FC-3-2430-30RorL	105"	36"	8088	335	62
	FC-3-2430-30RL	132"	36"	9414	370	86
	FC-3-2430-36RorL	111"	36"	8389	360	66
	FC-3-2430-36RL	144"	36"	9539	410	93

† Requires Two Sets of Faucets

Bowl Size	Model #	O.A. Length	O.A. Width	Price	Wt.	Cu.
30" x 24"	FFC-3-3024	95"	30"	\$6169	225	38
	FFC-3-3024-24RorL	117"	30"	8059	325	59
	FFC-3-3024-24RL	138"	30"	9244	360	81
	FFC-3-3024-30RorL	123"	30"	8446	350	62
	FFC-3-3024-30RL	150"	30"	9566	395	86
	FFC-3-3024-36RorL	129"	30"	8620	390	66
30" x 30"	FFC-3-3030-36RL	162"	30"	9904	425	93
	FFC-3-3030	95"	36"	8447	250	43
	FFC-3-3030-24RL	138"	36"	14293	390	96
	FFC-3-3030-30RL	150"	36"	14946	435	104
FFC-3-3030-36RL	162"	36"	15110	460	112	

† Requires Two Sets of Faucets

FOUR COMPARTMENT SINKS

Bowl Size	Model #	O.A. Length	O.A. Width	Price	Wt.	Cu.
18" x 18"	FC-4-1818-18RL†	106"	24"	\$6796	280	51
18" x 24"	FC-4-1824-18RL†	108"	30"	7568	340	62
24" x 24"	FC-4-2424-24RL†	144"	30"	9240	355	60

† Requires Two Sets of Faucets

Tubular KD Wall Mounted Drainage Shelves



- Stainless Steel
- 15" Deep
- 1-5/8" Diameter Stainless Steel Tubing

Model #	Size	Price
DT-6R-36	3'	\$1447
DT-6R-48	4'	1674
DT-6R-60	5'	1880
DT-6R-72	6'	2060

FABRICATED

Fabricated Sinks



SUPER STURDY
CROSS BRACING



SPEC-LINE 14 GAUGE FABRICATED SINKS

- 14 Ga. 304 Stainless Steel
- All Welded Super-Sturdy Cross-Bracing
- 14" Deep Bowls
- Tile Edge Splash
- Stainless Steel Legs & Adjustable Stainless Steel Bullet Feet
- Continuous Apron Design

Features and Benefits

- 3/4" Radius Corners
- Economical Savings
- Satin Finish



ONE COMPARTMENT SINKS

Bowl Size	Model #	O.A. Length	O.A. Width	Price	Wt.	Cu.
16" x 20"	FS-1-1620	21"	26"	\$3322	60	12
	FS-1-1620-18RorL	36.5"	26"	3570	60	20
	FS-1-1620-18RL	52"	26"	3879	100	27
18" x 18"	FS-1-1818	23"	24"	3388	60	11
	FS-1-1818-18RorL	38.5"	24"	3809	75	17
18" x 24"	FS-1-1824	23"	30"	3683	78	16
	FS-1-1824-18RorL	38.5"	30"	4216	92	25
	FS-1-1824-24RorL	44.5"	30"	4423	105	28
	FS-1-1824-18RL	54"	30"	4527	175	34
	FS-1-1824-24RL	66"	30"	4725	198	40
24" x 24"	FS-1-2424	29"	30"	4234	90	19
	FS-1-2424-18RorL	44.5"	30"	4761	110	28
	FS-1-2424-24RorL	50.5"	30"	4816	119	34
	FS-1-2424-18RL	60"	30"	4915	185	37
	FS-1-2424-24RL	72"	30"	5928	209	44
30" x 24"	FS-1-3024	35"	30"	4868	115	23
	FS-1-3024-24RorL	56.5"	30"	5711	190	35
	FS-1-3024-24RL	78"	30"	6138	240	47
36" x 24"	FS-1-3624	41"	30"	5504	140	26
	FS-1-3624-24RorL	62.5"	30"	6351	210	39
	FS-1-3624-24RL	84"	30"	8256	260	51
48" x 24"	FS-1-4824-24RL	96"	30"	8658	315	59



TWO COMPARTMENT SINKS

Bowl Size	Model #	O.A. Length	O.A. Width	Price	Wt.	Cu.
16" x 20"	FS-2-1620	37"	26"	\$4775	100	20
	FS-2-1620-18RorL	52.5"	26"	5187	120	27
	FS-2-1620-18RL	68"	26"	5315	143	34
18" x 18"	FS-2-1818	41"	24"	4868	98	18
	FS-2-1818-18RorL	56.5"	24"	5238	110	26
18" x 24"	FS-2-1818-18RL	72"	24"	5504	125	30
	FS-2-1824	41"	30"	5123	148	28
18" x 24"	FS-2-1824-18RorL	56.5"	30"	5649	168	35
	FS-2-1824-24RorL	62.5"	30"	6283	190	39
	FS-2-1824-18RL	72"	30"	6457	220	44
	FS-2-1824-24RL	84"	30"	7475	240	51
	FS-2-2424	53"	30"	5641	179	33
24" x 24"	FS-2-2424-18RorL	68.5"	30"	6909	200	42
	FS-2-2424-24RorL	74.5"	30"	7077	220	48
	FS-2-2424-18RL	84"	30"	7449	245	53
	FS-2-2424-24RL	96"	30"	7982	270	60
	FS-2-2030-18RorL	60.5"	36"	7150	250	45
20" x 30"	FS-2-2030-18RL	76"	36"	7427	260	54
	FS-2-2030-24RorL	66.5"	36"	7668	255	48
	FS-2-2030-24RL	88"	36"	7878	270	61
30" x 24"	FS-2-3024	65"	30"	6985	265	40
	FS-2-3024-24RorL	86.5"	30"	8256	300	52
	FS-2-3024-24RL	108"	30"	8679	320	64

Additional Sizes Available.
See Modifications & Accessories on Pages 35 & 36



Fabricated Bowls are Welded Together at the Seams & Polished



THREE COMPARTMENT SINKS

Bowl Size	Model #	O.A. Length	O.A. Width	Price	Wt.	Cu.
18" x 20"	FS-3-1620	53"	26"	\$6706	140	27
	FS-3-1620-18RorL	68.5"	26"	7462	160	35
	FS-3-1620-18RL	84"	26"	8191	155	36
	FS-3-1620-24RL	96"	26"	8809	235	47
	FS-3-1620-36RL	120"	26"	9117	260	58
18" x 18"	FS-3-1818	59"	24"	6985	130	25
	FS-3-1818-18RorL	75"	24"	7622	150	31
	FS-3-1818-18RL	90"	24"	8469	170	32
18" x 24"	FS-3-1824	59"	30"	7239	158	36
	FS-3-1824-18RorL	74.5"	30"	8131	174	46
	FS-3-1824-24RorL	80.5"	30"	8382	187	49
	FS-3-1824-18RL	90"	30"	9295	310	54
	FS-3-1824-24RL	102"	30"	9947	375	61
24" x 24"	FS-3-2424 [†]	77"	30"	8149	329	47
	FS-3-2424-18RorL [†]	92.5"	30"	9089	353	56
	FS-3-2424-24RorL [†]	98.5"	30"	9313	369	59
	FS-3-2424-18RL [†]	108"	30"	10266	382	64
	FS-3-2424-24RL [†]	120"	30"	10476	405	71

[†] Requires Two Sets of Faucets

FABRICATED

Fabricated Sinks

SPEC-LINE

14 GAUGE FABRICATED SINKS

- 14 Ga. 304 Stainless Steel
- 14" Deep Bowls
- Tile Edge Splash
- Continuous Apron Design
- All Welded Super-Sturdy Cross-Bracing
- Stainless Steel Legs & Adjustable Stainless Steel Bullet Feet

FC & FS Series Accessories

Optional Front Cross Bracing For FS Sinks
FC-CB-1 \$57 per foot



Stainless Steel Leg With Bullet Foot
K-475 \$100 per leg



Stainless Steel Sink Covers

See Page 35



Removable 12" Side Splashes For FC & FS Series Sinks

Accommodates Left & Right Sides



Model #	Price	Description
K-700	\$638	For FC & FS Series Sink Bowls: 10"x14", 14"x16", 15"x15", 16"x20"
K-700F-18	670	FC & FS Sink Bowls: 18"x18" Sink Bowls
K-700F-24	704	For FC & FS Series Sink Bowls: 15"x24", 18"x24", 24"x24" & 30"x24"
K-700F-30	778	For FC & FS Series Sink Bowls: 20"x30", 24"x30", 30"x30"

Popular Sink Faucets

8" Swing Spout Faucet
8" O.C.
K-1118 **\$630**



12" Swing Spout Faucet
8" O.C.
K-112 **\$674**



14" Swing Spout Faucet
8" O.C.
K-105 **\$704**



See Page 36 for Additional Faucets

BUDGET SINKS

Budget Line Scullery Sinks

 = Ship Via UPS

For Residential Finish & Packaging, Add K-350 \$457



- 18" & 21" Wide Sink Bowls Are 14" Deep
- 24" Wide Sink Bowls Are 13" Deep
- 3-1/2" Basket Drain
- 8" O.C. Faucet Holes On Splash

4-1-24 Shown

	Bowl Size	L	Wt.	Cu. Ft.	"400" Series (430 S/S)		"600" Series (300 S/S)	
					Model #	Price	Model #	Price
1 COMP.	18" x 18"	18"	44 lbs.	8	4-81-18	\$1510	6-81-18	\$1734
	21" x 18"	18"	47 lbs.	9	4-1-18	1537	N/A	-
	21" x 24"	24"	53 lbs.	12	4-1-24	1564	6-1-24	1959
	21" x 36"	36"	66 lbs.	16	4-1-36	1789	6-1-36	2014
	24" x 24"	24"	54 lbs.	12	4-41-24	1899	6-41-24	2099
	24" x 36"	36"	69 lbs.	17	4-41-36	2032	6-41-36	2240
2 COMP.	21" x 36"	36"	73 lbs.	16	4-2-36	2210	6-2-36	2490
	21" x 48"	48"	86 lbs.	21	4-2-48	2407	6-2-48	2739
	21" x 60"	60"	98 lbs.	26	4-2-60	3050	N/A	-
	24" x 48"	48"	88 lbs.	22	4-42-48	2659	6-42-48	2937
	24" x 60"	60"	108 lbs.	27	4-42-60	3221	N/A	-
3 COMP.	21" x 36"	36"	79 lbs.	16	4-3-36	2378	6-3-36	2659
	21" x 48"	48"	91 lbs.	21	4-3-48	2578	6-3-48	3050
	21" x 54"	54"	98 lbs.	24	4-3-54	2684	6-3-54	3133

3-1/2" Rear Deck Budget Sinks



- 14" Deep Bowls
- 4" Back Splash
- 3-1/2" Basket Drain
- 8" O.C. Faucet Holes On Deck

4-1-24D Shown



4-41-48D Shown



4" Back Splash

Bowl Size	L	Wt.	Cu. Ft.	"400" Series (430 S/S)		"600" Series (300 S/S)	
				Model #	Price	Model #	Price
21" x 18"	18"	47 lbs.	9	4-1-18D	\$1683	N/A	-
21" x 24"	24"	53 lbs.	12	4-1-24D	1729	6-1-24D	2075
24" x 24"	24"	54 lbs.	12	4-41-24D	2023	6-41-24D	2429
24" x 36"	36"	66 lbs.	17	4-41-36D	2115	6-41-36D	2538
24" x 48"	48"	79 lbs.	17	4-41-48D	2926	6-41-48D	3512

Heavy Duty Deck Mounted Service Faucets



Model #	Spout	Price
K-127	8"	\$630
K-128	12"	674
K-129	14"	704

Drainboards



- Drainboards 36" & Larger Supplied With Legs
- Sides & End Of Drainboard Turned Up with 2" Hemmed Edges Along Top

Model #	Size	Approx. Wt.	Approx. Cu. Ft.	Price
N-5-818	18" x 18"	13 lbs.	1	\$572
N-5-18	21" x 18"	15 lbs.	1	615
N-5-24	21" x 24"	18 lbs.	1	712
N-5-30	21" x 30"	22 lbs.	2	803
N-5-36	21" x 36"	25 lbs.	2	1286
N-5-48	21" x 48"	28 lbs.	3	1538
N-54-24	24" x 24"	20 lbs.	1	766
N-54-36	24" x 36"	25 lbs.	2	1353
N-54-48	24" x 48"	30 lbs.	3	1602

Stainless Steel Sink Covers For One Compartment Budget Sinks



Model #	Size	Price
LSC-81	18" x 18"	\$640
LSC-24	21" x 24"	640
LSC-242	24" x 24"	640
LSC-36	24" x 36"	640

Stores Conveniently On Side Of Sink

MOBILE & SILVER SOAK SINKS

Mobile Sinks

34" Working Height

A Multi-Purpose Unit.

Move it where the ACTION is! A must for the large food preparation type installation.



Model #	Bowl Size	Price	Approx. Wt.
9-FMS-20	22" x 22" x 8"	\$5881	50 lbs.
9-FMS-12	22" x 22" x 12"	6444	90 lbs.



Optional Chute
9-SS-1 \$678



Optional Bumpers
9-SS-2 \$319

Silver Soak Sinks

20" Working Height

UNIVERSAL BOWL SIZE.

Accommodates 19 3/4" x 19 3/4" Dishwasher Baskets



Model #	Bowl Size	Price	Approx. Wt.
9-FSS-20	22" x 22" x 8"	\$5619	42 lbs.

Silver Soak Sinks with Detachable Chute

20" Working Height

Required for the Scullery operation that promotes clean sanitary flatware.

Shown with Optional Bumpers



Model #	Bowl Size	Price	Approx. Wt.
9-FSC-20	22" x 22" x 8"	\$6161	90 lbs.

SINK MODS

Sink Modifications & Accessories



MODIFICATIONS

K-4	Support Bracket for Lever Waste Drain Handle	\$189 ea.
K-23	Sink Legs Welded To Undershelf Or Left-To-Right Cross Rails, Shipped Set Up & Crated. (Top Is Not Welded To Legs)	561 per sink
K-23A	Sink Legs Welded To Leg Gussets Under Sink Top & To Undershelf Or Left-To-Right Cross Rails, Shipped Set Up & Crated	741 per sink
K-24	Shell Crating	433
K-37	Anti-Siphon Vacuum Breaker Holes	168
K-57	Welded Field Joint (Welded in field by others)	391 per sink
K-76	Paint on Sound Deadening	746
K-77	Splash Cutout (Pipe Chase)	265
K-106	Mirror HighWire Edge for Sink	608
K-440	Waste Trough with 2" deep removable basket	1277
K-447	High Backsplash up to 18"	265 lin. ft.
K-448	High Backsplash up to 13"	212 lin. ft.
K-450	Extend Drainboard Length (Drainboards over 36" Are Not Crated or Pitched.)	537 lin. ft.
K-451	Drainboard Corner Turn	1876 ea.
K-452	Control Bracket 8" x 12"	373 ea.
K-452S	Splash Mounted Control Bracket 8" x 12"	422 ea.
K-453	Control Bracket 14" x 16"	400 ea.
K-453S	Splash Mounted Control Bracket 14" x 16"	466 ea.
K-454	Scoopsplash	581 ea.
K-456	Scrap Block Installed	546
K-460	Installation of Disposal Cone with 8" x 12" Control Bracket, Faucet Holes. (Cone supplied by others)	1115 ea.

K-460A	Installation of Disposal Cone with 14" x 16" Control Bracket, Faucet Holes (Cone supplied by others)	\$1184 ea.
K-461	Install Collar with 8" x 12" control bracket (Collar by others)	1115
K-461A	Install Collar with 14" x 16" control bracket (Collar by others)	1184
K-470	Modify Bowl Depth	242 ea.
K-472	Faucet Hole Revision	176 ea.
K-473	Working Height Revision	141 ea.
K-476	Punch for Over Flow Holes (Holes Only, N/C when ordering K-15)	79 ea.
K-479	Undershelf Under Drainboard	337 lin. ft.
K-480	Stainless Steel 12" Wide Shelf (min. of 3 ft.)	350 lin. ft.
K-480A	Stainless Steel 15" Wide Shelf (min. of 3 ft.)	503 lin. ft.
K-490	Provision for Pot Washer (For "Wells-PW-106" only)	1406 ea.
K-491	Provision for Hatco Heater	266 ea.
K-495	Turn Down Backsplash (Includes 2 Brackets, See K-397 Add'l Sets)	233
K-498	Tubular Overshelf 12" wide (Min. 3 Ft.)	528 lin. ft.
K-499	Stainless Steel Pot Rack	419 lin. ft.
K-500	Stainless Steel Apron to Cover Sink Bowls	1316 ea.
K-500A	17" Stainless Steel Apron to Cover Sink Bowls and Support Lever Drain Handles	1530 ea.
K-508	Special Sizing Charge (Larger size cut down to smaller size)	N/C ea.
K-508A	Special Modification Charge	355 ea.
K-510	Prepare Sink for Undercounter Dishwasher (24" drainboard or larger)	198 per sink
K-520	Poly Board/Stainless Steel Cover Holder	941 ea.
K-550	Stainless Steel Tubular Rack Storage	289 lin. ft.
K-ROD	Weld Support Rods For Poly Sink Cover in Corners Of Sink Bowl	674 ea.

ACCESSORIES

K-30	Faucet Wall Mounting Bracket	\$496 ea.
K-72	Leg To Wall Brace	415
K-350	Residential Finish & Packaging	503 ea.
K-397	Wall Bracket for Sink (Includes 2 Brackets with K-495 Mod.)	119 ea.
K-457	Replacement Rubber Scrap Block (See K-456 for install cost)	166 ea.
K-474	16 ga., "304" Series S/S Leg with S/S Foot	161 ea.
K-475	S/S Leg with S/S Foot	100 ea.
K-477	Replacement Leg Clamp for Adjustable Cross-Bracing	28 ea.
K-477C	Replacement Corner Leg Clamp for Adjustable Cross-Bracing	39 ea.
K-478	Stainless Steel Bullet Foot	40 ea.
K-488	Flanged S/S Bullet Foot	85 ea.
K-493	16 ga., "304" Series S/S Welded Leg Assembly with S/S Feet	532 ea.
K-494	S/S Welded Leg Assembly with S/S Feet	473 ea.
K-497	Galv. Welded Leg Assembly with Plastic Feet	317 ea.
K-497A	Galv. Individual Legs with Plastic Feet	114 set/4
K-496	Leg Assembly For Grease Interceptor w/ Adj. Cross-Bracing & S/S Feet (For Grease Interceptors with 15" Ht. or less. Consult factory for larger Grease Interceptors)	583 ea.
K-610	Perforated Stainless Steel Sink Grid (Specify Bowl Size)	1066 ea.

Model #	Size	Price	Tubular KD Wall Mounted Drainage Shelves
DT-6R-36	3"	\$1447	<ul style="list-style-type: none"> • Stainless Steel • 15" Deep • 1-5/8" Diameter Stainless Steel Tubing
DT-6R-48	4"	1674	
DT-6R-60	5"	1880	
DT-6R-72	6"	2060	



SINK COVERS

Choose Model # & Add The Proper Letter in Place Of The Underscore ().
Example: K-2A or FC-45J

Bowl Size	FOR DEEP DRAWN BOWLS		FOR FABRICATED BOWLS	
	Poly Covers Model K-2_ \$413	S/S Covers Model K-455_ \$691	Poly Covers Model K-2_ \$413	S/S Covers Model FC-455_ \$691
10" x 14"	A	A	AF	A
12" x 20"	I	I	IF	I
14" x 14"	H	H	HF	H
14" x 18"	B	B	BF	B
15" x 15"	Not Available	Not Available	MF	M
15" x 24"	Not Available	Not Available	VF	V
16" x 20"	C	C	CF	C
18" x 18"	Not Available	Not Available	JF	J
18" x 24"	D	D	DF	D
20" x 20"	E	E	EF	E
20" x 24"	Not Available	Not Available	PF	P
20" x 28"	G	G	GF	G
20" x 30"	Not Available	Not Available	SF	S
24" x 20"	Not Available	Not Available	TF	T
24" x 24"	F	F	FF	F
24" x 30"	Not Available	Not Available	RF	R
30" x 30"	Not Available	Not Available	UF	U

Custom Covers Available. Consult Factory.

K-ROD Welded Support Rods for Poly Sink Covers in Corners of Sink Bowl (Replaces Standard Support Clips) \$674 per bowl

FAUCETS & DRAINS

For Sinks & Dishtables

All Items On This Page Ship Via UPS

PRERINSE FAUCETS Wall Bracket Included

SPEC-LINE HEAVY DUTY Splash Mounted Prerinse Faucet
DTA-53 **\$1266**

Deck Mounted Prerinse Faucet
K-115 **\$1758**

Splash Mounted Prerinse Faucet
K-116 **\$1758**

12" Add-A-Faucet for DTA-53 Prerinse Faucets
K-117 **\$495**

12" Add-A-Faucet for K-115 & K-116 Prerinse Faucets
K-117-TS **\$771**

Replacement Hose Handle Not Included
K-113 **\$240**

Replacement Spray Head & Handle
K-114 **\$273**

HEAVY DUTY FAUCETS

8" Swing Spout Faucet
8" O.C.
K-1118 **\$630**

12" Swing Spout Faucet
8" O.C.
K-112 **\$674**

14" Swing Spout Faucet
8" O.C.
K-105 **\$704**

16" Swing Spout Faucet
8" O.C.
K-119 **\$733**

18" Swing Spout Faucet
8" O.C.
K-211 **\$784**

Faucet Mounting Kit for
K-1, K-11, K-101, K-1105, K-119, K-119, K-127, K-128, K-129, K-158, K-181, K-1118, K-211 & DTA-53
K-06 **\$136** Set of 2

Extra Heavy Duty T&S 14" Swing Spout Faucet
8" O.C.
K-111 **\$848**

Wall Mounted Service Faucet
8" O.C.
K-240 **\$1286**
*K-240 Does Not Meet Federal Lead Free Standards As It Is Not Intended For Potable Water

STANDARD DUTY FAUCETS

Model	Spout Length	Price
K-101	8"	\$316
K-1	12"	353
K-11	14"	403

WRIST HANDLES

For Standard Duty 8" O.C. Faucets
Fits K-1, K-11 & K-101
K-316-LU **\$167** set

For Heavy Duty 8" O.C. Faucets
Fits K-105, K-112, K-119, K-127, K-128, K-129, K-154, K-158, K-181, K-1118 & K-211
K-416-LU **\$275** set

For Extra Heavy Duty 8" O.C. Faucets
Fits K-488, K-111, K-115, K-118 & K-117-TS
K-416-TS-LU **\$492** set

Replacement Cartridges for K-1, K-11, K-101 & K-160
K-00B
\$151 (Set of 2)

Repair Kit can only be used on faucets purchased after 1/2016

Replacement Cartridges
Fits K-105, K-112, K-119, K-127, K-128, K-129, K-158, K-181, K-1118 & K-211
K-07 **\$229** (Set of 2)

Faucet Wall Mounting Bracket
K-30
\$443
For use when no backplash is available to mount faucet

Heavy Duty Replacement Spouts

Model	Spout Size/Style	Price
K-1118SP	8" Swing Spout	\$206
K-1125P	12" Swing Spout	220
K-1055P	14" Swing Spout	245
K-1195P	18" Swing Spout	256
K-2115P	18" Swing Spout	270

Standard Duty Replacement Spouts

K-1015P	8" Swing Spout	96
K-15P	12" Swing Spout	116
K-115P	14" Swing Spout	125

Vacuum Breaker Repair Kit For K-240
K-03 **\$160**

Continuous Waste For 3 Compartment Sink
1-1/2" Dia.
K-351 For Use with 2 & 3 Compartment Sinks
\$495

Chrome Plated P-Trap

Heavy Gauge (17 Gauge)
7-PS-10 **\$187**

Standard Gauge (22 Gauge)
7-PS-14 **\$166**

Replacement Drains

Assembly K-6 **\$64** (1-1/2" IPS)

Basket K-310 **\$40**

Strainer Plate for 3-1/2" Drain K-410 **\$34**

Twist Handle Operated Drain 2" IPS
K-5 **\$388**

Twist Handle Operated Drain with Overflow
K-15 **\$712**

Twist Drain Support Bracket K-4 **\$189**

SPEC-LINE Twist Handle Operated Drain
K-40 **\$1273** (All Stainless Steel)

Replacement "O" Rings for Twist Handle Operated Drains
For K-6 & K-15 Drains
K-05 Washer for Twist Handle **\$28**

WARNING: Equipment that includes a faucet may expose you to chemicals, including lead, that are known to the State of California to cause cancer or birth defects or other reproductive harm. For more info, visit www.p65warnings.ca.gov.



Consult Factory For Additional Sizes
Custom Sizes Available - Call For Pricing.

Ship Via UPS



FLOOR TROUGHS

Floor Troughs & Floor Drains

- 14 Gauge 304 Stainless Steel
- Stainless Steel Or Fiberglass Grating
- Pitched Towards Waste
- Subway Grating Constructed From 3/16" X 1" Bars
- Grating Is Spaced 9/16" (Inside Clearance) Between Bars To Prevent Casters From Getting Trapped
- Includes 4" Od. - 3' Long Plumbing Sleeve
- Includes Stainless Steel Strainer Basket With Handle

Size W x L x D	With S/S Grate	Price	Approx. Weight	With Fiberglass Grate	Price	Approx. Weight
12" x 24" x 4"	FTG-1224	\$4326	48 lbs.	FFTG-1224	\$4158	34 lbs.
12" x 30" x 4"	FTG-1230	4433	56 lbs.	FFTG-1230	4280	37 lbs.
12" x 36" x 4"	FTG-1236	4578	66 lbs.	FFTG-1236	4401	40 lbs.
12" x 42" x 4"	FTG-1242	4875	76 lbs.	FFTG-1242	4670	43 lbs.
12" x 48" x 4"	FTG-1248	5657	86 lbs.	FFTG-1248	5380	46 lbs.
12" x 54" x 4"	FTG-1254	6139	96 lbs.	FFTG-1254	5819	49 lbs.
12" x 60" x 4"	FTG-1260	6785	106 lbs.	FFTG-1260	6400	52 lbs.
12" x 72" x 4"	FTG-1272	7799	116 lbs.	FFTG-1272	7326	55 lbs.
12" x 84" x 4"	FTG-1284	9158	126 lbs.	FFTG-1284	8556	61 lbs.
12" x 96" x 4"	FTG-1296*	9427	146 lbs.	FFTG-1296*	8802	90 lbs.
12" x 108" x 4"	FTG-12108*	10236	166 lbs.	FFTG-12108*	9536	99 lbs.
12" x 120" x 4"	FTG-12120*	12396	180 lbs.	FFTG-12120*	11490	108 lbs.
18" x 24" x 4"	FTG-1824	4875	62 lbs.	FFTG-1824	4644	43 lbs.
18" x 30" x 4"	FTG-1830	5114	74 lbs.	FFTG-1830	4893	47 lbs.
18" x 36" x 4"	FTG-1836	5388	86 lbs.	FFTG-1836	5134	54 lbs.
18" x 42" x 4"	FTG-1842	5764	98 lbs.	FFTG-1842	5481	61 lbs.
18" x 48" x 4"	FTG-1848	6400	110 lbs.	FFTG-1848	6054	69 lbs.
18" x 54" x 4"	FTG-1854	7212	122 lbs.	FFTG-1854	6793	76 lbs.
18" x 60" x 4"	FTG-1860	7907	134 lbs.	FFTG-1860	7416	83 lbs.
18" x 72" x 4"	FTG-1872	8656	146 lbs.	FFTG-1872	8100	90 lbs.
18" x 84" x 4"	FTG-1884	10507	165 lbs.	FFTG-1884	9778	111 lbs.
18" x 96" x 4"	FTG-1896*	10776	187 lbs.	FFTG-1896*	10022	125 lbs.
18" x 108" x 4"	FTG-18108*	12396	208 lbs.	FFTG-18108*	11490	138 lbs.
18" x 120" x 4"	FTG-18120*	14281	229 lbs.	FFTG-18120*	13203	150 lbs.
24" x 24" x 4"	FTG-2424	5869	69 lbs.	FFTG-2424	4832	52 lbs.
24" x 30" x 4"	FTG-2430	6111	81 lbs.	FFTG-2430	5257	59 lbs.
24" x 36" x 4"	FTG-2436	6969	104 lbs.	FFTG-2436	5380	68 lbs.
24" x 42" x 4"	FTG-2442	7335	118 lbs.	FFTG-2442	5807	75 lbs.
24" x 48" x 4"	FTG-2448	8067	131 lbs.	FFTG-2448	6111	83 lbs.
24" x 54" x 4"	FTG-2454	8802	145 lbs.	FFTG-2454	6845	95 lbs.
24" x 60" x 4"	FTG-2460	9048	162 lbs.	FFTG-2460	7579	102 lbs.
24" x 72" x 4"	FTG-2472	10517	195 lbs.	FFTG-2472	8312	119 lbs.
24" x 84" x 4"	FTG-2484	11490	218 lbs.	FFTG-2484	9903	137 lbs.
24" x 96" x 4"	FTG-2496*	12712	243 lbs.	FFTG-2496*	10148	153 lbs.
24" x 108" x 4"	FTG-24108*	14429	274 lbs.	FFTG-24108*	11733	168 lbs.
24" x 120" x 4"	FTG-24120*	15402	310 lbs.	FFTG-24120*	13445	188 lbs.

*Include Two Drains

7.5" Wide Floor Water Receptacles (4" Depth)



- 14 Gauge 304 Stainless Steel
- Includes Stainless Steel Subway Grating constructed from 3/16" x 1" bars.

Stainless Steel Grating	Size W x L x D	Price	Approx. Weight
FTG-724	7.5" x 24" x 4"	\$3079	44 lbs.
FTG-730	7.5" x 30" x 4"	3285	44 lbs.
FTG-736	7.5" x 36" x 4"	3482	63 lbs.
FTG-748	7.5" x 48" x 4"	4131	82 lbs.
FTG-760	7.5" x 60" x 4"	4462	101 lbs.
FTG-772	7.5" x 72" x 4"	4784	110 lbs.
FTG-784	7.5" x 84" x 4"	5110	119 lbs.
FTG-796	7.5" x 96" x 4"	5437	138 lbs.
FTG-7108	7.5" x 108" x 4"	5777	157 lbs.
FTG-7120	7.5" x 120" x 4"	6120	170 lbs.

12" Wide Floor Water Receptacles (2" Depth)



- 14 Gauge 304 Stainless Steel
- Includes Stainless Steel Subway Grating constructed from 3/16" x 1" bars

Stainless Steel Grating	Size W x L x D	Price	Approx. Weight
FRG-24	12" x 24" x 2"	\$4162	44 lbs.
FRG-36	12" x 30" x 2"	4747	63 lbs.
FRG-48	12" x 48" x 2"	5502	82 lbs.

12" Wide Floor Drain (4" Depth)

- 14 Gauge 304 Stainless Steel
- Includes Strainer Basket

FD-1 \$941

Optional Stainless Steel Grate



Stainless Steel Grating	Size W x L x D	Price	Approx. Weight
FOR-1212	12" x 12" x 4"	\$2157	26 lbs.

FLOOR TROUGH ACCESSORIES & MODIFICATIONS



Cut-Out View of Anti-Splash

FT-1 \$158 lin. ft.

Optional Anti-Splash Guard (Factory Installed)



FT-2 \$85 ea.

Replacement Stainless Steel Strainer Basket with Handle

FT-3 \$173 lin. ft.

Modify Trough Depth (2" to 6" Deep)

FT-4 \$360 per hole

Modify Drain Outlet Size (Allow 2" to 8" Dia)

FT-5 \$183 lin. ft.

Grate Upgrade to A.D.A.

FT-6 No Charge

Modify Length of Trough (Select Next Larger Size)

TABLES

Flat Top W/ Undershef

Stainless Steel TOP
Stainless Steel UNDERSHELF
Stainless Steel LEGS



Ship Via UPS



VSS Series
Countertop Edge



SS, MS, SAG Series
Bull Nose Edge

	Spec-Line		Premium		Standard		Super Saver		Approx. Shipping Weight	Approx. Cubic Feet	
	14 Ga. 304 S/S	14 Ga. 304 S/S	14 Ga. 304 S/S	14 Ga. 304 S/S	16 Ga. 304 S/S	16 Ga. 304 S/S	16 Ga. 430 S/S	16 Ga. 430 S/S			
	Length	Model #	Price	Model #	Price	Model #	Price	Model #	Price		
24" WIDE	2'	VSS-242	\$2506	SS-242	\$1674	MS-242	\$1551	SAG-242	\$1506	31 lbs.	3
	30"	VSS-240	2696	SS-240	1857	MS-240	1714	SAG-240	1642	49 lbs.	4
	3'	VSS-243	2789	SS-243	1958	MS-243	1811	SAG-243	1735	64 lbs.	5
	4'	VSS-244	2869	SS-244	2044	MS-244	1880	SAG-244	1782	79 lbs.	6
	5'	VSS-245	3059	SS-245	2225	MS-245	2035	SAG-245	1929	92 lbs.	8
	6'	VSS-246	3244	SS-246	2411	MS-246	2203	SAG-246	2070	109 lbs.	9
	7'	VSS-247	4012	SS-247	3307	MS-247	3031	SAG-247	2552	130 lbs.	11
	8'	VSS-248	4243	SS-248	3542	MS-248	3243	SAG-248	2745	145 lbs.	12
	9'	VSS-249	4986	SS-249	4552	MS-249	4345	SAG-249	3909	161 lbs.	14
	10'	VSS-2410	5309	SS-2410	4874	MS-2410	4453	SAG-2410	4226	261 lbs.	26
	11'	VSS-2411	5764	SS-2411	5224	MS-2411	4753	SAG-2411	4480	293 lbs.	29
	12'	VSS-2412	5881	SS-2412	5337	MS-2412	4869	SAG-2412	4598	308 lbs.	32
30" WIDE	2'	VSS-302	2696	SS-302	1857	MS-302	1714	SAG-302	1642	55 lbs.	4
	30"	VSS-300	2805	SS-300	1971	MS-300	1821	SAG-300	1711	65 lbs.	5
	3'	VSS-303	2902	SS-303	2072	MS-303	1911	SAG-303	1826	72 lbs.	6
	4'	VSS-304	3022	SS-304	2197	MS-304	2012	SAG-304	1899	89 lbs.	8
	5'	VSS-305	3247	SS-305	2415	MS-305	2219	SAG-305	2082	107 lbs.	9
	6'	VSS-306	3599	SS-306	2527	MS-306	2280	SAG-306	2256	126 lbs.	11
	7'	VSS-307	4147	SS-307	3292	MS-307	3014	SAG-307	2651	148 lbs.	13
	8'	VSS-308	4316	SS-308	3643	MS-308	3421	SAG-308	2971	166 lbs.	15
	9'	VSS-309	5466	SS-309	4927	MS-309	4488	SAG-309	4197	176 lbs.	17
	10'	VSS-3010	5786	SS-3010	5247	MS-3010	4805	SAG-3010	4520	267 lbs.	32
	11'	VSS-3011	6207	SS-3011	5678	MS-3011	5178	SAG-3011	4843	324 lbs.	35
	12'	VSS-3012	6323	SS-3012	5795	MS-3012	5299	SAG-3012	4954	339 lbs.	37
36" WIDE	2'	VSS-362	3406	SS-362	2388	MS-362	2240	SAG-362	2061	81 lbs.	7
	3'	VSS-363	3458	SS-363	2438	MS-363	2296	SAG-363	2116	88 lbs.	7
	4'	VSS-364	3528	SS-364	2506	MS-364	2369	SAG-364	2190	98 lbs.	9
	5'	VSS-365	3791	SS-365	2768	MS-365	2605	SAG-365	2430	118 lbs.	11
	6'	VSS-366	4067	SS-366	3018	MS-366	2840	SAG-366	2659	138 lbs.	13
	7'	VSS-367	4965	SS-367	4093	MS-367	3867	SAG-367	3673	164 lbs.	16
	8'	VSS-368	5276	SS-368	4393	MS-368	4139	SAG-368	3966	184 lbs.	18
	9'	VSS-369	6423	SS-369	5864	MS-369	5485	SAG-369	5156	190 lbs.	20
	10'	VSS-3610	6739	SS-3610	6181	MS-3610	5805	SAG-3610	5478	308 lbs.	38
	11'	VSS-3611	7238	SS-3611	6695	MS-3611	6269	SAG-3611	5871	358 lbs.	41
	12'	VSS-3612	7357	SS-3612	6802	MS-3612	6380	SAG-3612	5984	373 lbs.	45
	48" WIDE	4'	VSS-484	6457	SS-484	5013	NOT AVAILABLE				158 lbs.
5'		VSS-485	6987	SS-485	5537	184 lbs.					15
6'		VSS-486	7505	SS-486	6048	218 lbs.					17
7'		VSS-487	9629	SS-487	8183	260 lbs.					20
8'		VSS-488	10286	SS-488	8831	290 lbs.					23
9'		VSS-489	11922	SS-489	10382	322 lbs.					44
10'		VSS-4810	12125	SS-4810	10584	522 lbs.					49
11'		VSS-4811	12328	SS-4811	10788	601 lbs.					54
12'	VSS-4812	12533	SS-4812	10992	616 lbs.	58					

38 Units 8 ft. and larger furnished with 6 legs. SPECIAL LENGTHS: Select next largest size. Add Model # TA-61 No Charge (ex. SS-306 with TA-61 size to 66" long).

Featuring as Standard: "THE PROVEN"
Original ADVANCE TABCO Adjustable
Undershelf with Die Cast Leg Clamp



VLG Series
Countertop Edge



GLG, MG, AG Series
Bull Nose Edge



TABLES

Flat Top W/ Undershell

Stainless Steel TOP
Galvanized UNDERSHELF
Galvanized LEGS

	Spec-Line		Premium		Standard		Super Saver		Approx. Shipping Weight	Approx. Cubic Feet	
	14 Ga. 304 S/S	14 Ga. 304 S/S	14 Ga. 304 S/S	14 Ga. 304 S/S	16 Ga. 304 S/S	16 Ga. 304 S/S	16 Ga. 430 S/S	16 Ga. 430 S/S			
	Length	Model #	Price	Model #	Price	Model #	Price	Model #	Price		
24" WIDE	2'	VLG-242	\$2012	GLG-242	\$1200	MG-242	\$1146	AG-242	\$1069	31 lbs.	3
	30"	VLG-240	2152	GLG-240	1326	MG-240	1244	AG-240	1163	49 lbs.	4
	3'	VLG-243	2247	GLG-243	1428	MG-243	1342	AG-243	1260	64 lbs.	5
	4'	VLG-244	2288	GLG-244	1447	MG-244	1368	AG-244	1286	79 lbs.	6
	5'	VLG-245	2415	GLG-245	1585	MG-245	1481	AG-245	1356	92 lbs.	8
	6'	VLG-246	2569	GLG-246	1723	MG-246	1603	AG-246	1447	109 lbs.	9
	7'	VLG-247	3134	GLG-247	2345	MG-247	2299	AG-247	1849	130 lbs.	11
	8'	VLG-248	3313	GLG-248	2521	MG-248	2463	AG-248	2105	145 lbs.	12
	9'	VLG-249	3790	GLG-249	3138	MG-249	2944	AG-249	2820	161 lbs.	14
	10'	VLG-2410	4115	GLG-2410	3452	MG-2410	3267	AG-2410	3138	201 lbs.	20
	11'	VLG-2411	4447	GLG-2411	3683	MG-2411	3452	AG-2411	3149	293 lbs.	29
	12'	VLG-2412	4568	GLG-2412	3801	MG-2412	3568	AG-2412	3268	308 lbs.	30
30" WIDE	2'	VLG-302	2152	GLG-302	1326	MG-302	1244	AG-302	1163	55 lbs.	4
	30"	VLG-300	2207	GLG-300	1373	MG-300	1290	AG-300	1191	65 lbs.	5
	3'	VLG-303	2302	GLG-303	1467	MG-303	1386	AG-303	1289	72 lbs.	6
	4'	VLG-304	2363	GLG-304	1526	MG-304	1430	AG-304	1313	89 lbs.	8
	5'	VLG-305	2534	GLG-305	1682	MG-305	1573	AG-305	1436	107 lbs.	9
	6'	VLG-306	2703	GLG-306	1841	MG-306	1723	AG-306	1551	125 lbs.	11
	7'	VLG-307	3273	GLG-307	2481	MG-307	2336	AG-307	1944	148 lbs.	13
	8'	VLG-308	3501	GLG-308	2707	MG-308	2539	AG-308	2253	166 lbs.	15
	9'	VLG-309	4147	GLG-309	3392	MG-309	3179	AG-309	2862	176 lbs.	17
	10'	VLG-3010	4464	GLG-3010	3704	MG-3010	3502	AG-3010	3183	207 lbs.	20
	11'	VLG-3011	4758	GLG-3011	4065	MG-3011	3737	AG-3011	3380	324 lbs.	35
	12'	VLG-3012	4877	GLG-3012	4098	MG-3012	3853	AG-3012	3501	339 lbs.	37
36" WIDE	2'	VLG-362	2718	GLG-362	1676	MG-362	1613	AG-362	1437	81 lbs.	7
	3'	VLG-363	2772	GLG-363	1725	MG-363	1667	AG-363	1520	88 lbs.	7
	4'	VLG-364	2844	GLG-364	1788	MG-364	1737	AG-364	1630	98 lbs.	9
	5'	VLG-365	3060	GLG-365	2012	MG-365	1949	AG-365	1840	118 lbs.	11
	6'	VLG-366	3267	GLG-366	2189	MG-366	2116	AG-366	2012	138 lbs.	13
	7'	VLG-367	3939	GLG-367	2957	MG-367	2883	AG-367	2770	164 lbs.	16
	8'	VLG-368	4128	GLG-368	3139	MG-368	3050	AG-368	2944	184 lbs.	18
	9'	VLG-369	4924	GLG-369	4094	MG-369	3982	AG-369	3626	190 lbs.	20
	10'	VLG-3610	5246	GLG-3610	4421	MG-3610	4300	AG-3610	3930	308 lbs.	30
	11'	VLG-3611	5585	GLG-3611	4792	MG-3611	4613	AG-3611	4182	358 lbs.	41
	12'	VLG-3612	5706	GLG-3612	4905	MG-3612	4723	AG-3612	4293	373 lbs.	45
	48" WIDE	4'	VLG-484	5761	GLG-484	4321	NOT AVAILABLE				158 lbs.
5'		VLG-485	6270	GLG-485	4832	184 lbs.					15
6'		VLG-486	6683	GLG-486	4838	218 lbs.					17
7'		VLG-487	8555	GLG-487	7115	260 lbs.					20
8'		VLG-488	8982	GLG-488	7533	290 lbs.					23
9'		VLG-489	10536	GLG-489	9002	322 lbs.					44
10'		VLG-4810	10746	GLG-4810	9207	522 lbs.					49
11'		VLG-4811	10948	GLG-4811	9413	601 lbs.					54
12'	VLG-4812	11150	GLG-4812	9611	616 lbs.	58					

TABLES

Flat Top W/ Open Base

Stainless Steel TOP
Stainless Steel LEGS



TVSS Series
Countertop Edge



TSS, TMS, TSAG Series
Bullnose Edge

	Spec-Line		Premium		Standard		Super Saver		Approx. Shipping Weight	Approx. Cubic Feet	
	Length	Model #	Price	Model #	Price	Model #	Price	Model #			Price
24" WIDE	2'	TVSS-242	\$2690	TSS-242	\$1852	TMS-242	\$1734	TSAG-242	\$1682	25 lbs.	3
	30"	TVSS-240	2869	TSS-240	2044	TMS-240	1892	TSAG-240	1822	42 lbs.	4
	3'	TVSS-243	2971	TSS-243	2140	TMS-243	1988	TSAG-243	1916	53 lbs.	5
	4'	TVSS-244	3054	TSS-244	2224	TMS-244	2059	TSAG-244	1964	64 lbs.	6
	5'	TVSS-245	3242	TSS-245	2407	TMS-245	2219	TSAG-245	2099	74 lbs.	8
	6'	TVSS-246	3431	TSS-246	2594	TMS-246	2386	TSAG-246	2248	85 lbs.	9
	7'	TVSS-247	4189	TSS-247	3480	TMS-247	3216	TSAG-247	2734	103 lbs.	11
	8'	TVSS-248	4428	TSS-248	3722	TMS-248	3430	TSAG-248	2924	114 lbs.	12
	9'	TVSS-249	5179	TSS-249	4748	TMS-249	4330	TSAG-249	4094	130 lbs.	14
	10'	TVSS-2410	5502	TSS-2410	5069	TMS-2410	4644	TSAG-2410	4421	227 lbs.	26
	11'	TVSS-2411	5954	TSS-2411	5416	TMS-2411	4951	TSAG-2411	4673	251 lbs.	29
	12'	TVSS-2412	6074	TSS-2412	5531	TMS-2412	5063	TSAG-2412	4786	266 lbs.	32
30" WIDE	2'	TVSS-302	2770	TSS-302	1939	TMS-302	1803	TSAG-302	1744	47 lbs.	4
	30"	TVSS-300	2988	TSS-300	2158	TMS-300	2002	TSAG-300	1907	52 lbs.	5
	3'	TVSS-303	3082	TSS-303	2253	TMS-303	2092	TSAG-303	2011	59 lbs.	6
	4'	TVSS-304	3212	TSS-304	2382	TMS-304	2190	TSAG-304	2085	72 lbs.	8
	5'	TVSS-305	3433	TSS-305	2605	TMS-305	2399	TSAG-305	2262	85 lbs.	9
	6'	TVSS-306	3779	TSS-306	2831	TMS-306	2594	TSAG-306	2438	93 lbs.	11
	7'	TVSS-307	4335	TSS-307	3630	TMS-307	3347	TSAG-307	2833	113 lbs.	13
	8'	TVSS-308	4496	TSS-308	4012	TMS-308	3685	TSAG-308	3149	126 lbs.	15
	9'	TVSS-309	5660	TSS-309	5122	TMS-309	4675	TSAG-309	4392	150 lbs.	17
	10'	TVSS-3010	5974	TSS-3010	5435	TMS-3010	4996	TSAG-3010	4715	261 lbs.	32
	11'	TVSS-3011	6402	TSS-3011	5866	TMS-3011	5368	TSAG-3011	5031	268 lbs.	35
	12'	TVSS-3012	6516	TSS-3012	5982	TMS-3012	5481	TSAG-3012	5143	283 lbs.	37
36" WIDE	2'	TVSS-362	3587	TSS-362	2570	TMS-362	2421	TSAG-362	2240	70 lbs.	7
	3'	TVSS-363	3641	TSS-363	2620	TMS-363	2475	TSAG-363	2299	75 lbs.	7
	4'	TVSS-364	3714	TSS-364	2690	TMS-364	2549	TSAG-364	2378	82 lbs.	9
	5'	TVSS-365	3975	TSS-365	2945	TMS-365	2782	TSAG-365	2609	96 lbs.	11
	6'	TVSS-366	4253	TSS-366	3210	TMS-366	3018	TSAG-366	2840	108 lbs.	13
	7'	TVSS-367	5148	TSS-367	4261	TMS-367	4034	TSAG-367	3861	127 lbs.	16
	8'	TVSS-368	5456	TSS-368	4579	TMS-368	4330	TSAG-368	4138	140 lbs.	18
	9'	TVSS-369	6619	TSS-369	6054	TMS-369	5680	TSAG-369	5346	165 lbs.	20
	10'	TVSS-3610	6929	TSS-3610	6373	TMS-3610	5998	TSAG-3610	5667	261 lbs.	38
	11'	TVSS-3611	7429	TSS-3611	6870	TMS-3611	6457	TSAG-3611	6069	290 lbs.	41
	12'	TVSS-3612	7544	TSS-3612	6998	TMS-3612	6579	TSAG-3612	6181	305 lbs.	45
	48" WIDE	4'	TVSS-484	6639	TSS-484	5188	NOT AVAILABLE				128 lbs.
5'		TVSS-485	7174	TSS-485	5727	148 lbs.					15
6'		TVSS-486	7679	TSS-486	6228	170 lbs.					17
7'		TVSS-487	9815	TSS-487	8364	206 lbs.					20
8'		TVSS-488	10461	TSS-488	9015	228 lbs.					23
9'		TVSS-489	12106	TSS-489	10579	260 lbs.					44
10'		TVSS-4810	12311	TSS-4810	10782	454 lbs.					49
11'		TVSS-4811	12513	TSS-4811	10986	517 lbs.					54
12'	TVSS-4812	12718	TSS-4812	11189	532 lbs.	56					

40 Units 8 ft. and larger furnished with 8 legs. SPECIAL LENGTHS: Select next largest size. Add Model # TA-61 No Charge (ex. SS-306 with TA-61 size to 66" long).

TABLES

Flat Top W/ Open Base



TVLG Series
Countertop Edge



Stainless Steel TOP
Galvanized LEGS

	Spec-Line		Premium		Standard		Super Saver		Approx. Shipping Weight	Approx. Cubic Feet	
	Length	Model #	Price	Model #	Price	Model #	Price	Model #			Price
24" WIDE	2'	TVLG-242	\$2190	TGLG-242	\$1376	TMG-242	\$1324	TAG-242	\$1251	25 lbs.	3
	30"	TVLG-240	2333	TGLG-240	1508	TMG-240	1430	TAG-240	1342	42 lbs.	4
	3'	TVLG-243	2423	TGLG-243	1603	TMG-243	1520	TAG-243	1439	53 lbs.	5
	4'	TVLG-244	2467	TGLG-244	1632	TMG-244	1540	TAG-244	1464	64 lbs.	6
	5'	TVLG-245	2605	TGLG-245	1767	TMG-245	1660	TAG-245	1537	74 lbs.	8
	6'	TVLG-246	2749	TGLG-246	1896	TMG-246	1782	TAG-246	1632	85 lbs.	9
	7'	TVLG-247	3317	TGLG-247	2533	TMG-247	2481	TAG-247	2031	103 lbs.	11
	8'	TVLG-248	3491	TGLG-248	2698	TMG-248	2646	TAG-248	2292	114 lbs.	12
	9'	TVLG-249	3982	TGLG-249	3523	TMG-249	3134	TAG-249	3004	130 lbs.	14
	10'	TVLG-2410	4300	TGLG-2410	3847	TMG-2410	3449	TAG-2410	3324	227 lbs.	26
	11'	TVLG-2411	4640	TGLG-2411	3879	TMG-2411	3654	TAG-2411	3340	251 lbs.	29
	12'	TVLG-2412	4754	TGLG-2412	3990	TMG-2412	3770	TAG-2412	3452	266 lbs.	32
30" WIDE	2'	TVLG-302	\$2221	TGLG-302	1397	TMG-302	1328	TAG-302	1262	47 lbs.	4
	30"	TVLG-300	2388	TGLG-300	1551	TMG-300	1474	TAG-300	1375	52 lbs.	5
	3'	TVLG-303	2482	TGLG-303	1651	TMG-303	1573	TAG-303	1471	59 lbs.	6
	4'	TVLG-304	2543	TGLG-304	1713	TMG-304	1608	TAG-304	1496	72 lbs.	8
	5'	TVLG-305	2717	TGLG-305	1870	TMG-305	1749	TAG-305	1616	85 lbs.	9
	6'	TVLG-306	2892	TGLG-306	2025	TMG-306	1896	TAG-306	1734	93 lbs.	11
	7'	TVLG-307	3457	TGLG-307	2659	TMG-307	2508	TAG-307	2121	113 lbs.	13
	8'	TVLG-308	3686	TGLG-308	2894	TMG-308	2720	TAG-308	2434	126 lbs.	15
	9'	TVLG-309	4340	TGLG-309	3573	TMG-309	3366	TAG-309	3060	150 lbs.	17
	10'	TVLG-3010	4655	TGLG-3010	3903	TMG-3010	3685	TAG-3010	3380	261 lbs.	32
	11'	TVLG-3011	4954	TGLG-3011	4167	TMG-3011	3929	TAG-3011	3566	268 lbs.	35
	12'	TVLG-3012	5073	TGLG-3012	4286	TMG-3012	4043	TAG-3012	3683	283 lbs.	37
36" WIDE	2'	TVLG-362	2897	TGLG-362	1847	TMG-362	1788	TAG-362	1676	70 lbs.	7
	3'	TVLG-363	2952	TGLG-363	1899	TMG-363	1845	TAG-363	1737	75 lbs.	7
	4'	TVLG-364	3022	TGLG-364	1970	TMG-364	1918	TAG-364	1818	82 lbs.	9
	5'	TVLG-365	3243	TGLG-365	2190	TMG-365	2129	TAG-365	2023	96 lbs.	11
	6'	TVLG-366	3452	TGLG-366	2369	TMG-366	2299	TAG-366	2190	108 lbs.	13
	7'	TVLG-367	4124	TGLG-367	3142	TMG-367	3059	TAG-367	2949	127 lbs.	16
	8'	TVLG-368	4313	TGLG-368	3319	TMG-368	3226	TAG-368	3088	140 lbs.	18
	9'	TVLG-369	5113	TGLG-369	4291	TMG-369	4175	TAG-369	3809	165 lbs.	20
	10'	TVLG-3610	5433	TGLG-3610	4611	TMG-3610	4494	TAG-3610	4125	261 lbs.	38
	11'	TVLG-3611	5786	TGLG-3611	4987	TMG-3611	4805	TAG-3611	4370	290 lbs.	41
	12'	TVLG-3612	5900	TGLG-3612	5102	TMG-3612	4921	TAG-3612	4492	305 lbs.	45
	48" WIDE	4'	TVLG-484	5911	TGLG-484	4497	NOT AVAILABLE				128 lbs.
5'		TVLG-485	6457	TGLG-485	5013	148 lbs.					15
6'		TVLG-486	6998	TGLG-486	5425	170 lbs.					17
7'		TVLG-487	8743	TGLG-487	7297	206 lbs.					20
8'		TVLG-488	9155	TGLG-488	7709	228 lbs.					23
9'		TVLG-489	10725	TGLG-489	9188	260 lbs.					44
10'		TVLG-4810	10931	TGLG-4810	9394	454 lbs.					49
11'		TVLG-4811	11136	TGLG-4811	9596	517 lbs.					54
12'	TVLG-4812	11339	TGLG-4812	9802	532 lbs.	58					

TABLES

1-1/2" Rear Splash W/ Undershef

Stainless Steel TOP
Stainless Steel UNDERSHELF
Stainless Steel LEGS



Premium

Standard

Super Saver

14 Ga. 304 S/S

16 Ga. 304 S/S

16 Ga. 430 S/S

Approx. Shipping Weight
Approx. Cubic Feet

Length	Premium		Standard		Super Saver		Approx. Shipping Weight	Approx. Cubic Feet
	Model #	Price	Model #	Price	Model #	Price		
24" WIDE	2'	FSS-242	\$1822	FMS-242	\$1696	SFG-242	\$1652	31 lbs. 3
	30"	FSS-240	2011	FMS-240	1850	SFG-240	1784	49 lbs. 4
	3'	FSS-243	2099	FMS-243	1949	SFG-243	1887	64 lbs. 5
	4'	FSS-244	2189	FMS-244	2020	SFG-244	1933	79 lbs. 6
	5'	FSS-245	2378	FMS-245	2178	SFG-245	2070	92 lbs. 8
	6'	FSS-246	2560	FMS-246	2341	SFG-246	2210	109 lbs. 9
	7'	FSS-247	3450	FMS-247	3172	SFG-247	2697	130 lbs. 11
	8'	FSS-248	3685	FMS-248	3380	SFG-248	2894	145 lbs. 12
	9'	FSS-249	4704	FMS-249	4291	SFG-249	4067	161 lbs. 14
	10'	FSS-2410	5030	FMS-2410	4611	SFG-2410	4374	261 lbs. 26
	11'	FSS-2411	5376	FMS-2411	4904	SFG-2411	4631	293 lbs. 29
	12'	FSS-2412	5487	FMS-2412	5019	SFG-2412	4751	308 lbs. 32
30" WIDE	2'	FSS-302	1896	FMS-302	1769	SFG-302	1714	55 lbs. 4
	30"	FSS-300	2116	FMS-300	1964	SFG-300	1882	65 lbs. 5
	3'	FSS-303	2210	FMS-303	2063	SFG-303	1970	72 lbs. 6
	4'	FSS-304	2340	FMS-304	2158	SFG-304	2045	89 lbs. 8
	5'	FSS-305	2569	FMS-305	2358	SFG-305	2224	107 lbs. 9
	6'	FSS-306	2795	FMS-306	2560	SFG-306	2401	125 lbs. 11
	7'	FSS-307	3599	FMS-307	3309	SFG-307	2802	148 lbs. 13
	8'	FSS-308	3969	FMS-308	3654	SFG-308	3112	166 lbs. 15
	9'	FSS-309	5091	FMS-309	4641	SFG-309	4360	176 lbs. 17
	10'	FSS-3010	5401	FMS-3010	4956	SFG-3010	4673	287 lbs. 32
	11'	FSS-3011	5823	FMS-3011	5328	SFG-3011	4994	324 lbs. 35
	12'	FSS-3012	5948	FMS-3012	5444	SFG-3012	5105	339 lbs. 37
36" WIDE	2'	FSS-362	2530	FMS-362	2396	SFG-362	2209	75 lbs. 7
	3'	FSS-363	2583	FMS-363	2443	SFG-363	2265	88 lbs. 7
	4'	FSS-364	2651	FMS-364	2508	SFG-364	2338	98 lbs. 9
	5'	FSS-365	2912	FMS-365	2749	SFG-365	2576	118 lbs. 11
	6'	FSS-366	3164	FMS-366	2988	SFG-366	2805	138 lbs. 13
	7'	FSS-367	4236	FMS-367	4012	SFG-367	3816	164 lbs. 16
	8'	FSS-368	4549	FMS-368	4288	SFG-368	4105	184 lbs. 18
	9'	FSS-369	6016	FMS-369	5634	SFG-369	5306	190 lbs. 20
	10'	FSS-3610	6332	FMS-3610	5954	SFG-3610	5630	223 lbs. 38
	11'	FSS-3611	6839	FMS-3611	6417	SFG-3611	6023	350 lbs. 41
	12'	FSS-3612	6959	FMS-3612	6536	SFG-3612	6146	365 lbs. 45

Units 8 ft. and larger furnished with 6 legs. **SPECIAL LENGTHS:** Select next largest size. Add **Model # TA-61 No Charge** (ex. SS-306 with TA-61 size to 66" long).



Adjustable Single and Double Table Mounted Overshelves
See Pages 74.



For Adjustable Components Featuring Potracks & Overshelves
10", 12" 15" & 18"
See Page 80 & 81.





Featuring as Standard: "THE PROVEN"
Original ADVANCE TABCO Adjustable Undershell
with Die Cast Leg Clamp



FLG, FMG, FAG Series
Bullnose Edge

Stainless Steel TOP
Galvanized UNDERSHELF
Galvanized LEGS

TABLES

1-1/2" Rear Splash
W/ Undershell



	Length	Premium		Standard		Super Saver		Approx. Shipping Weight	Approx. Cubic Feet
		Model #	Price	Model #	Price	Model #	Price		
		14 Ga. 304 S/S		16 Ga. 304 S/S		16 Ga. 430 S/S			
24" WIDE	2'	FLG-242	\$1342	FMG-242	\$1289	FAG-242	\$1210	31 lbs.	3
	30"	FLG-240	1474	FMG-240	1386	FAG-240	1311	49 lbs.	4
	3'	FLG-243	1573	FMG-243	1486	FAG-243	1399	64 lbs.	5
	4'	FLG-244	1599	FMG-244	1508	FAG-244	1419	79 lbs.	6
	5'	FLG-245	1733	FMG-245	1621	FAG-245	1505	92 lbs.	8
	6'	FLG-246	1857	FMG-246	1744	FAG-246	1599	109 lbs.	9
	7'	FLG-247	2494	FMG-247	2451	FAG-247	1999	130 lbs.	11
	8'	FLG-248	2660	FMG-248	2609	FAG-248	2256	145 lbs.	12
	9'	FLG-249	3297	FMG-249	3100	FAG-249	2967	161 lbs.	14
	10'	FLG-2410	3610	FMG-2410	3418	FAG-2410	3286	201 lbs.	26
	11'	FLG-2411	3843	FMG-2411	3610	FAG-2411	3367	293 lbs.	29
	12'	FLG-2412	3960	FMG-2412	3729	FAG-2412	3420	308 lbs.	32
30" WIDE	2'	FLG-302	1368	FMG-302	1294	FAG-302	1228	55 lbs.	4
	30"	FLG-300	1511	FMG-300	1438	FAG-300	1337	65 lbs.	5
	3'	FLG-303	1612	FMG-303	1531	FAG-303	1436	72 lbs.	6
	4'	FLG-304	1668	FMG-304	1571	FAG-304	1447	89 lbs.	8
	5'	FLG-305	1835	FMG-305	1723	FAG-305	1575	107 lbs.	9
	6'	FLG-306	1988	FMG-306	1857	FAG-306	1696	125 lbs.	11
	7'	FLG-307	2627	FMG-307	2475	FAG-307	2087	148 lbs.	13
	8'	FLG-308	2856	FMG-308	2686	FAG-308	2399	166 lbs.	15
	9'	FLG-309	3542	FMG-309	3325	FAG-309	3014	176 lbs.	17
	10'	FLG-3010	3860	FMG-3010	3654	FAG-3010	3337	287 lbs.	32
	11'	FLG-3011	4129	FMG-3011	3900	FAG-3011	3526	324 lbs.	35
	12'	FLG-3012	4248	FMG-3012	4012	FAG-3012	3653	339 lbs.	37
36" WIDE	2'	FLG-362	1817	FMG-362	1766	FAG-362	1662	75 lbs.	7
	3'	FLG-363	1870	FMG-363	1818	FAG-363	1711	85 lbs.	7
	4'	FLG-364	1940	FMG-364	1889	FAG-364	1777	98 lbs.	9
	5'	FLG-365	2158	FMG-365	2092	FAG-365	1979	118 lbs.	11
	6'	FLG-366	2336	FMG-366	2265	FAG-366	2158	138 lbs.	13
	7'	FLG-367	3108	FMG-367	3018	FAG-367	2913	164 lbs.	16
	8'	FLG-368	3282	FMG-368	3197	FAG-368	3083	184 lbs.	18
	9'	FLG-369	4250	FMG-369	4138	FAG-369	3777	190 lbs.	20
	10'	FLG-3610	4569	FMG-3610	4323	FAG-3610	4094	223 lbs.	38
	11'	FLG-3611	4952	FMG-3611	4761	FAG-3611	4333	350 lbs.	41
	12'	FLG-3612	5069	FMG-3612	4884	FAG-3612	4450	365 lbs.	45

SIDE SPLASH



TA-30 1 1/2" Side Splash **\$130 ea.**
TA-31 3" Side Splash **242 ea.**
TA-32 10 1/2" Side Splash **474 ea.**

K.D. ALUMINUM PAN RACK SLIDES

6 Slides - 2" Spacing
Mounted on Tables (min. length 3')

TA-44 **\$944**



Glass Rack Slides
3 Slides - 7 1/2" Spacing
TA-45 **\$862**

WORKTABLE CASTERS

When Used with Galvanized Legs

TA-25G-4 **\$579/set of 4**
TA-25G-6 **866/set of 6**

5" Swivels with rubber wheels
Each set with 2 brakes. Legs maintain 35-1/2" working height

TA-25B **\$284** For Brakes on all wheels for TA-25G-4 or TA-25G-6

TA-25C X.H.D. Urethane wheels **\$50** each castler

See Page 68 For More Casters



3 TIER DRAWERS



Stainless Steel
TA-38 **\$5433**

20" x 20" x 5"
Drawer Inserts with Ball Bearing Slides

URN TROUGH



TA-64 **\$229/lin.ft.**

See pages 61-68 for Additional Accessories & Modifications

TABLES

1-1/2" Rear Splash W/ Open Base

Stainless Steel TOP
Stainless Steel LEGS



TFSS, TFMS, TSFG Series
Bullnose Edge



	Premium			Standard			Super Saver			Approx. Shipping Weight	Approx. Cubic Feet
	Length	Model #	Price	Model #	Price	Model #	Price	14 Ga. 304 S/S	16 Ga. 304 S/S		
24" WIDE	2'	TFSS-242	\$2002	TFMS-242	\$1882	TSFG-242	\$1857				25 lbs. 3
	30"	TFSS-240	2189	TFMS-240	2035	TSFG-240	1968				42 lbs. 4
	3'	TFSS-243	2288	TFMS-243	2134	TSFG-243	2065				53 lbs. 5
	4'	TFSS-244	2369	TFMS-244	2203	TSFG-244	2103				64 lbs. 6
	5'	TFSS-245	2552	TFMS-245	2358	TSFG-245	2248				74 lbs. 8
	6'	TFSS-246	2743	TFMS-246	2523	TSFG-246	2396				85 lbs. 8
	7'	TFSS-247	3626	TFMS-247	3354	TSFG-247	2883				103 lbs. 11
	8'	TFSS-248	3869	TFMS-248	3570	TSFG-248	3069				114 lbs. 12
	9'	TFSS-249	4897	TFMS-249	4486	TSFG-249	4250				130 lbs. 14
	10'	TFSS-2410	5223	TFMS-2410	4795	TSFG-2410	4569				227 lbs. 26
	11'	TFSS-2411	5565	TFMS-2411	5100	TSFG-2411	4826				251 lbs. 29
	12'	TFSS-2412	5684	TFMS-2412	5216	TSFG-2412	4918				266 lbs. 32
30" WIDE	2'	TFSS-302	2082	TFMS-302	1949	TSFG-302	1892				47 lbs. 4
	30"	TFSS-300	2234	TFMS-300	2144	TSFG-300	2060				52 lbs. 5
	3'	TFSS-303	2396	TFMS-303	2244	TSFG-303	2153				59 lbs. 6
	4'	TFSS-304	2521	TFMS-304	2338	TSFG-304	2225				72 lbs. 8
	5'	TFSS-305	2749	TFMS-305	2539	TSFG-305	2402				85 lbs. 9
	6'	TFSS-306	2974	TFMS-306	2648	TSFG-306	2583				93 lbs. 11
	7'	TFSS-307	3779	TFMS-307	3490	TSFG-307	2979				113 lbs. 13
	8'	TFSS-308	4139	TFMS-308	3826	TSFG-308	3292				126 lbs. 15
	9'	TFSS-309	5277	TFMS-309	4833	TSFG-309	4550				150 lbs. 17
	10'	TFSS-3010	5585	TFMS-3010	5147	TSFG-3010	4866				242 lbs. 32
	11'	TFSS-3011	6019	TFMS-3011	5514	TSFG-3011	5187				268 lbs. 35
	12'	TFSS-3012	6141	TFMS-3012	5635	TSFG-3012	5302				283 lbs. 37
36" WIDE	2'	TFSS-362	2715	TFMS-362	2571	TSFG-362	2406				65 lbs. 7
	3'	TFSS-363	2763	TFMS-363	2622	TSFG-363	2451				70 lbs. 7
	4'	TFSS-364	2833	TFMS-364	2696	TSFG-364	2511				77 lbs. 9
	5'	TFSS-365	3089	TFMS-365	2925	TSFG-365	2751				91 lbs. 11
	6'	TFSS-366	3348	TFMS-366	3164	TSFG-366	2988				103 lbs. 13
	7'	TFSS-367	4421	TFMS-367	4189	TSFG-367	4007				122 lbs. 16
	8'	TFSS-368	4725	TFMS-368	4465	TSFG-368	4286				135 lbs. 18
	9'	TFSS-369	6210	TFMS-369	5822	TSFG-369	5503				180 lbs. 20
	10'	TFSS-3610	6526	TFMS-3610	6148	TSFG-3610	5819				253 lbs. 38
	11'	TFSS-3611	7030	TFMS-3611	6611	TSFG-3611	6221				282 lbs. 41
	12'	TFSS-3612	7149	TFMS-3612	6732	TSFG-3612	6332				297 lbs. 45

Units 8 ft. and larger furnished with 6 legs. **SPECIAL LENGTHS:** Select next largest size. Add **Model # TA-61 No Charge** (ex. SS-306 with TA-61 size to 60" long).

SELECTED SPEC-LINE UPGRADES

TA-3	Stainless Steel Hat Channel & Gusset	\$79 /lin. ft.
TA-94	16 ga. S/S 304 Undersheff. (any size)	75 /lin. ft.
TA-95	16 ga. S/S 304 Legs	185 /table
TA-23	Legs Welded to Undersheff or Cross-Rails, Shipped Set Up & Crated.	561 /table
TA-23A	Table Legs Welded To Leg Gussets & Undersheff or Cross-Bracing, Shipped Set Up & Crated.	741 /table

WORKTABLE CASTERS

Maintains the 35-1/2" Working Height

TA-255-4	4 Casters for Work Tables (2 w/ Brakes)	\$594 /set of 4
TA-255-6	6 Casters for Work Tables (2 w/ Brakes)	897 /set of 6
TA-25	4 Casters for Open Base Tables (2 w/ Brakes)	594 /set of 4
TA-25A	6 Casters for Open Base Tables (2 w/ Brakes)	897 /set of 6

See Page 68 for More Caster Options



TFLG, TFMG, TFAG Series
Buttress Edge

TABLES

1-1/2" Rear Splash W/ Open Base

Stainless Steel TOP
Galvanized LEGS



	Premium			Standard			Super Saver			Approx. Shipping Weight	Approx. Cubic Feet	
	Length	Model #	Price	Model #	Price	Model #	Price	14 Ga. 304 S/S	16 Ga. 304 S/S			16 Ga. 430 S/S
24" WIDE	2'	TFLG-242	\$1841	TFMG-242	\$1471	TFAG-242	\$1388				25 lbs.	3
	30"	TFLG-240	1653	TFMG-240	1571	TFAG-240	1487				42 lbs.	4
	3'	TFLG-243	1749	TFMG-243	1662	TFAG-243	1583				53 lbs.	5
	4'	TFLG-244	1779	TFMG-244	1686	TFAG-244	1608				64 lbs.	6
	5'	TFLG-245	1905	TFMG-245	1803	TFAG-245	1681				74 lbs.	8
	6'	TFLG-246	2044	TFMG-246	1933	TFAG-246	1779				85 lbs.	9
	7'	TFLG-247	2680	TFMG-247	2627	TFAG-247	2177				103 lbs.	11
	8'	TFLG-248	2844	TFMG-248	2789	TFAG-248	2438				114 lbs.	12
	9'	TFLG-249	3480	TFMG-249	3295	TFAG-249	3164				130 lbs.	14
	10'	TFLG-2410	3802	TFMG-2410	3607	TFAG-2410	3488				227 lbs.	26
	11'	TFLG-2411	4027	TFMG-2411	3802	TFAG-2411	3627				251 lbs.	29
	12'	TFLG-2412	4146	TFMG-2412	3912	TFAG-2412	3713				266 lbs.	32
30" WIDE	2'	TFLG-302	1540	TFMG-302	1475	TFAG-302	1410				47 lbs.	4
	30"	TFLG-300	1696	TFMG-300	1618	TFAG-300	1517				52 lbs.	5
	3'	TFLG-303	1788	TFMG-303	1714	TFAG-303	1616				59 lbs.	6
	4'	TFLG-304	1849	TFMG-304	1748	TFAG-304	1632				72 lbs.	8
	5'	TFLG-305	2012	TFMG-305	1896	TFAG-305	1762				85 lbs.	9
	6'	TFLG-306	2174	TFMG-306	2044	TFAG-306	1882				93 lbs.	11
	7'	TFLG-307	2805	TFMG-307	2658	TFAG-307	2266				113 lbs.	13
	8'	TFLG-308	3033	TFMG-308	2866	TFAG-308	2581				126 lbs.	15
	9'	TFLG-309	3729	TFMG-309	3523	TFAG-309	3214				150 lbs.	17
	10'	TFLG-3010	4046	TFMG-3010	3847	TFAG-3010	3526				242 lbs.	32
	11'	TFLG-3011	4323	TFMG-3011	4089	TFAG-3011	3728				268 lbs.	35
	12'	TFLG-3012	4437	TFMG-3012	4199	TFAG-3012	3843				283 lbs.	37
36" WIDE	2'	TFLG-362	2032	TFMG-362	1933	TFAG-362	1838				65 lbs.	7
	3'	TFLG-363	2068	TFMG-363	1990	TFAG-363	1889				70 lbs.	7
	4'	TFLG-364	2116	TFMG-364	2068	TFAG-364	1958				77 lbs.	9
	5'	TFLG-365	2338	TFMG-365	2273	TFAG-365	2168				91 lbs.	11
	6'	TFLG-366	2508	TFMG-366	2451	TFAG-366	2338				103 lbs.	13
	7'	TFLG-367	3287	TFMG-367	3210	TFAG-367	3099				122 lbs.	16
	8'	TFLG-368	3462	TFMG-368	3376	TFAG-368	3268				135 lbs.	18
	9'	TFLG-369	4516	TFMG-369	4330	TFAG-369	3964				160 lbs.	20
	10'	TFLG-3610	4758	TFMG-3610	4644	TFAG-3610	4285				253 lbs.	38
	11'	TFLG-3611	5139	TFMG-3611	4956	TFAG-3611	4527				282 lbs.	41
	12'	TFLG-3612	5250	TFMG-3612	5074	TFAG-3612	4640				297 lbs.	45

**QUICK
METRIC
CONVERSION
TABLE**

CONVERT FROM	INTO	MULTIPLY BY
Inches	Cubic Feet	L x W x H divided by 1728
Meters	Inches	39.37
Meters	Feet	3.28
Centimeters	Inches	0.3937
Millimeters	Inches	0.03937
Cubic Inches	Gallons	L x W x H Divided By 231

TABLES

10" & 5" Rear Splash W/ Undershef

Stainless Steel TOP
Stainless Steel UNDERSHELF
Stainless Steel LEGS



VKS Series
10" Back Splash
Countertop Edge



KSS, KMS, SKG Series
5" Back Splash
Bullnose Edge



Spec-Line

Premium

Standard

Super Saver

14 Ga. 304 S/S

14 Ga. 304 S/S

16 Ga. 304 S/S

16 Ga. 430 S/S

Approx. Shipping Weight

Approx. Cubic Feet

Length	Model #	Price	Model #	Price	Model #	Price	Model #	Price	Approx. Shipping Weight	Approx. Cubic Feet
2'	VKS-242	\$3161	KSS-242	\$2163	KMS-242	\$2045	SKG-242	\$1943	50 lbs.	5
30"	VKS-240	3348	KSS-240	2349	KMS-240	2207	SKG-240	2179	55 lbs.	6
3'	VKS-243	3450	KSS-243	2452	KMS-243	2302	SKG-243	2275	66 lbs.	7
4'	VKS-244	3538	KSS-244	2549	KMS-244	2386	SKG-244	2330	81 lbs.	9
5'	VKS-245	3719	KSS-245	2745	KMS-245	2560	SKG-245	2467	95 lbs.	12
6'	VKS-246	3904	KSS-246	2944	KMS-246	2743	SKG-246	2617	113 lbs.	14
7'	VKS-247	4654	KSS-247	3779	KMS-247	3521	SKG-247	3099	125 lbs.	16
8'	VKS-248	4891	KSS-248	4023	KMS-248	3747	SKG-248	3287	150 lbs.	18
9'	VKS-249	5689	KSS-249	5123	KMS-249	4719	SKG-249	4486	165 lbs.	21
10'	VKS-2410	6013	KSS-2410	5444	KMS-2410	5040	SKG-2410	4795	268 lbs.	28
11'	VKS-2411	6460	KSS-2411	5819	KMS-2411	5369	SKG-2411	5062	301 lbs.	36
12'	VKS-2412	6580	KSS-2412	5941	KMS-2412	5485	SKG-2412	5173	316 lbs.	39
2'	VKS-302	3243	KSS-302	2234	KMS-302	2092	SKG-302	2103	56 lbs.	6
30"	VKS-300	3461	KSS-300	2473	KMS-300	2308	SKG-300	2273	70 lbs.	7
3'	VKS-303	3561	KSS-303	2564	KMS-303	2407	SKG-303	2373	77 lbs.	9
4'	VKS-304	3683	KSS-304	2698	KMS-304	2511	SKG-304	2451	92 lbs.	11
5'	VKS-305	3907	KSS-305	2937	KMS-305	2739	SKG-305	2622	111 lbs.	14
6'	VKS-306	4129	KSS-306	3180	KMS-306	2952	SKG-306	2789	129 lbs.	17
7'	VKS-307	4806	KSS-307	3920	KMS-307	3654	SKG-307	3069	153 lbs.	20
8'	VKS-308	5171	KSS-308	4311	KMS-308	4012	SKG-308	3511	171 lbs.	22
9'	VKS-309	6167	KSS-309	5503	KMS-309	5052	SKG-309	4775	289 lbs.	25
10'	VKS-3010	6488	KSS-3010	5819	KMS-3010	5383	SKG-3010	5093	294 lbs.	40
11'	VKS-3011	6908	KSS-3011	6271	KMS-3011	5786	SKG-3011	5416	331 lbs.	43
12'	VKS-3012	7026	KSS-3012	6384	KMS-3012	5900	SKG-3012	5531	346 lbs.	47
2'	VKS-362	4072	KSS-362	3054	KMS-362	2844	SKG-362	2602	86 lbs.	10
3'	VKS-363	4123	KSS-363	3104	KMS-363	2892	SKG-363	2659	92 lbs.	10
4'	VKS-364	4191	KSS-364	3172	KMS-364	2955	SKG-364	2734	101 lbs.	14
5'	VKS-365	4459	KSS-365	3576	KMS-365	3337	SKG-365	2971	121 lbs.	17
6'	VKS-366	4732	KSS-366	3841	KMS-366	3573	SKG-366	3210	142 lbs.	20
7'	VKS-367	5630	KSS-367	4579	KMS-367	4255	SKG-367	4213	169 lbs.	23
8'	VKS-368	5936	KSS-368	4902	KMS-368	4554	SKG-368	4503	189 lbs.	27
9'	VKS-369	7107	KSS-369	6557	KMS-369	6037	SKG-369	5737	260 lbs.	30
10'	VKS-3610	7432	KSS-3610	6873	KMS-3610	6355	SKG-3610	6054	315 lbs.	46
11'	VKS-3611	7935	KSS-3611	7400	KMS-3611	6831	SKG-3611	6448	358 lbs.	51
12'	VKS-3612	8056	KSS-3612	7520	KMS-3612	6949	SKG-3612	6568	373 lbs.	55

Units 8 ft. and larger furnished with 6 leg **SPECIAL LENGTHS:** Select next largest size. Add **Model # TA-61 No Charge** (ex. SS-306 with TA-61 size to 60" long).



PATENT PENDING



Revolutionary SHD Series Drawer with Integral Drawer Slides

- Stainless Steel Front & Sides
- Self Closing Drawer with Noise Control
- Drawer "Safety Stop" Tab
- Removable Stainless Steel Insert
- Units can be Stacked to Create Tier Drawers

DELUXE SERIES

- Stainless Steel Front
- Ball Bearing Slides
- Removable Insert

Model #	Insert Size	Price
SS-2015	20" x 15" x 5"	\$791
SS-1520	15" x 20" x 5"	791
SS-2020	20" x 20" x 5"	856



Model #	Insert Size	Price
SHD-2015	20" x 15" x 5"	\$1443
SHD-1520	15" x 20" x 5"	1443
46 SHD-2020	20" x 20" x 5"	1541

See Pages 66-67 For More Drawer Details and More Drawer Options!



Featuring as Standard: "THE PROVEN"
Original ADVANCE TABCO Adjustable Undershell
with Die Cast Leg Clamp



TABLES

10" & 5" Rear Splash W/ Undershell

Stainless Steel TOP
Galvanized UNDERSHELF
Galvanized LEGS
Super Saver



VKG Series
10" Back Splash
Countertop Edge



KLG, KMG, KAG Series
5" Back Splash
Bullnose Edge

Spec-Line

Premium

Standard

Length	14 Ga. 304 S/S		14 Ga. 304 S/S		16 Ga. 304 S/S		16 Ga. 430 S/S		Approx. Shipping Weight	Approx. Cubic Feet	
	Model #	Price	Model #	Price	Model #	Price	Model #	Price			
24" WIDE	2'	VKG-242	\$2768	KLG-242	\$1597	KMG-242	\$1559	KAG-242	\$1475	50 lbs.	5
	30"	VKG-240	2913	KLG-240	1734	KMG-240	1682	KAG-240	1575	55 lbs.	6
	3'	VKG-243	3012	KLG-243	1826	KMG-243	1779	KAG-243	1668	66 lbs.	7
	4'	VKG-244	3059	KLG-244	1880	KMG-244	1819	KAG-244	1674	81 lbs.	9
	5'	VKG-245	3212	KLG-245	2012	KMG-245	1949	KAG-245	1788	95 lbs.	12
	6'	VKG-246	3358	KLG-246	2158	KMG-246	2085	KAG-246	1895	113 lbs.	14
	7'	VKG-247	3957	KLG-247	2745	KMG-247	2658	KAG-247	2330	135 lbs.	16
	8'	VKG-248	4147	KLG-248	2925	KMG-248	2864	KAG-248	2594	150 lbs.	18
	9'	VKG-249	4758	KLG-249	3626	KMG-249	3479	KAG-249	3324	165 lbs.	21
	10'	VKG-2410	5078	KLG-2410	3930	KMG-2410	3801	KAG-2410	3653	208 lbs.	28
	11'	VKG-2411	5455	KLG-2411	4082	KMG-2411	4023	KAG-2411	3879	301 lbs.	36
	12'	VKG-2412	5565	KLG-2412	4248	KMG-2412	4135	KAG-2412	3990	318 lbs.	39
30" WIDE	2'	VKG-302	2794	KLG-302	1620	KMG-302	1575	KAG-302	1487	56 lbs.	6
	30"	VKG-300	2960	KLG-300	1782	KMG-300	1734	KAG-300	1608	70 lbs.	7
	3'	VKG-303	2944	KLG-303	1883	KMG-303	1826	KAG-303	1703	77 lbs.	9
	4'	VKG-304	3139	KLG-304	1948	KMG-304	1889	KAG-304	1733	92 lbs.	11
	5'	VKG-305	3322	KLG-305	2114	KMG-305	2044	KAG-305	1852	111 lbs.	14
	6'	VKG-306	3498	KLG-306	2288	KMG-306	2208	KAG-306	1975	129 lbs.	17
	7'	VKG-307	4105	KLG-307	2869	KMG-307	2780	KAG-307	2434	153 lbs.	20
	8'	VKG-308	4366	KLG-308	3113	KMG-308	3009	KAG-308	2751	171 lbs.	22
	9'	VKG-309	5144	KLG-309	3867	KMG-309	3713	KAG-309	3561	195 lbs.	25
	10'	VKG-3010	5462	KLG-3010	4182	KMG-3010	4027	KAG-3010	3879	294 lbs.	40
	11'	VKG-3011	5786	KLG-3011	4478	KMG-3011	4300	KAG-3011	4146	331 lbs.	43
	12'	VKG-3012	5900	KLG-3012	4596	KMG-3012	4421	KAG-3012	4254	346 lbs.	47
36" WIDE	2'	VKG-362	3518	KLG-362	2327	KMG-362	2257	KAG-362	2105	86 lbs.	10
	3'	VKG-363	3576	KLG-363	2378	KMG-363	2296	KAG-363	2178	92 lbs.	10
	4'	VKG-364	3658	KLG-364	2451	KMG-364	2345	KAG-364	2253	101 lbs.	14
	5'	VKG-365	3889	KLG-365	2690	KMG-365	2605	KAG-365	2443	121 lbs.	17
	6'	VKG-366	4104	KLG-366	2883	KMG-366	2781	KAG-366	2587	142 lbs.	20
	7'	VKG-367	4826	KLG-367	3376	KMG-367	3255	KAG-367	3059	169 lbs.	23
	8'	VKG-368	5023	KLG-368	3790	KMG-368	3665	KAG-368	3447	189 lbs.	27
	9'	VKG-369	5973	KLG-369	4674	KMG-369	4492	KAG-369	4343	260 lbs.	30
	10'	VKG-3610	6287	KLG-3610	4994	KMG-3610	4808	KAG-3610	4667	315 lbs.	46
	11'	VKG-3611	6673	KLG-3611	5337	KMG-3611	5133	KAG-3611	4965	358 lbs.	51
	12'	VKG-3612	6785	KLG-3612	5455	KMG-3612	5247	KAG-3612	5079	373 lbs.	55

SIDE SPLASH



TA-30 1 1/2" Side Splash **\$130** ea.
TA-31 5" Side Splash **242** ea.
TA-32 10 1/2" Side Splash **474** ea.

K.D. ALUMINUM PAN RACK SLIDES

6 Slides - 2" Spacing
Mounted on Tables (min. length 3')

TA-44 **\$944**



Glass Rack Slides
3 Slides - 7 1/2" Spacing
TA-45 **\$862**

WORKTABLE CASTERS

When Used with Galvanized Legs

TA-25G-4 **\$594**/set of 4
TA-25G-6 **897**/set of 6

5" Swivels with rubber wheels
Each set with 2 brakes. Legs maintain 35-1/2" working height

TA-25B **\$284** For Brakes on all wheels for TA-25G-4 or TA-25G-6

TA-25C X.H.D. Urethane wheels **\$50** each caster

See Page 68 For More Casters



3 TIER DRAWERS



Stainless Steel

TA-38 **\$5433**

20" x 20" x 5"
Drawer Inserts with Ball Bearing Slides

URN TROUGH



TA-64 **\$218/lin.ft.**

TABLES

10" & 5" Rear Splash W/ Open Base

Stainless Steel TOP
Stainless Steel LEGS



TVKS Series
10" Back Splash
Countertop Edge



TKSS, TKMS, TSKG Series
5" Back Splash
Bullnose Edge

TKSS, TKMS,
TSKG Series
5" Back Splash
Bullnose Edge

Spec-Line

Premium

Standard

Super Saver

14 Ga. 304 S/S

14 Ga. 304 S/S

16 Ga. 304 S/S

16 Ga. 430 S/S

Approx. Shipping Weight

Approx. Cubic Feet

Length	Spec-Line			Premium			Standard			Super Saver			Approx. Shipping Weight	Approx. Cubic Feet
	Model #	Price	Model #	Price	Model #	Price	Model #	Price	Model #	Price				
24" WIDE	2'	TVKS-242	53347	TKSS-242	52340	TKMS-242	52225	TSKG-242	52225	43 lbs.	5			
	30"	TVKS-240	3528	TKSS-240	2534	TKMS-240	2388	TSKG-240	2363	49 lbs.	6			
	3'	TVKS-243	3628	TKSS-243	2630	TKMS-243	2482	TSKG-243	2460	55 lbs.	7			
	4'	TVKS-244	3716	TKSS-244	2732	TKMS-244	2560	TSKG-244	2505	67 lbs.	9			
	5'	TVKS-245	3903	TKSS-245	2924	TKMS-245	2743	TSKG-245	2647	77 lbs.	12			
	6'	TVKS-246	4088	TKSS-246	3128	TKMS-246	2922	TSKG-246	2794	89 lbs.	14			
	7'	TVKS-247	4837	TKSS-247	3953	TKMS-247	3695	TSKG-247	3273	107 lbs.	16			
	8'	TVKS-248	5072	TKSS-248	4203	TKMS-248	3924	TSKG-248	3464	119 lbs.	18			
	9'	TVKS-249	5876	TKSS-249	5310	TKMS-249	4905	TSKG-249	4674	135 lbs.	21			
	10'	TVKS-2410	6201	TKSS-2410	5635	TKMS-2410	5228	TSKG-2410	4994	234 lbs.	28			
	11'	TVKS-2411	6662	TKSS-2411	6014	TKMS-2411	5564	TSKG-2411	5247	258 lbs.	36			
	12'	TVKS-2412	6772	TKSS-2412	6130	TKMS-2412	5678	TSKG-2412	5361	273 lbs.	39			
30" WIDE	2'	TVKS-302	3430	TKSS-302	2413	TKMS-302	2291	TSKG-302	2291	48 lbs.	6			
	30"	TVKS-300	3651	TKSS-300	2648	TKMS-300	2490	TSKG-300	2457	55 lbs.	7			
	3'	TVKS-303	3744	TKSS-303	2748	TKMS-303	2587	TSKG-303	2549	62 lbs.	9			
	4'	TVKS-304	3868	TKSS-304	2896	TKMS-304	2697	TSKG-304	2627	75 lbs.	11			
	5'	TVKS-305	4093	TKSS-305	3123	TKMS-305	2919	TSKG-305	2804	89 lbs.	14			
	6'	TVKS-306	4316	TKSS-306	3358	TKMS-306	3134	TSKG-306	2979	97 lbs.	17			
	7'	TVKS-307	4990	TKSS-307	4104	TKMS-307	3826	TSKG-307	3376	118 lbs.	20			
	8'	TVKS-308	5350	TKSS-308	4489	TKMS-308	4189	TSKG-308	3689	131 lbs.	22			
	9'	TVKS-309	6367	TKSS-309	5694	TKMS-309	5253	TSKG-309	4969	150 lbs.	25			
	10'	TVKS-3010	6676	TKSS-3010	6014	TKMS-3010	5566	TSKG-3010	5298	249 lbs.	40			
	11'	TVKS-3011	7102	TKSS-3011	6464	TKMS-3011	5974	TSKG-3011	5607	278 lbs.	43			
	12'	TVKS-3012	7218	TKSS-3012	6582	TKMS-3012	6094	TSKG-3012	5720	291 lbs.	47			
36" WIDE	2'	TVKS-362	4253	TKSS-362	3227	TKMS-362	3012	TSKG-362	2786	75 lbs.	10			
	3'	TVKS-363	4302	TKSS-363	3282	TKMS-363	3068	TSKG-363	2840	80 lbs.	10			
	4'	TVKS-364	4370	TKSS-364	3354	TKMS-364	3139	TSKG-364	2913	85 lbs.	14			
	5'	TVKS-365	4638	TKSS-365	3766	TKMS-365	3515	TSKG-365	3149	99 lbs.	17			
	6'	TVKS-366	4908	TKSS-366	4025	TKMS-366	3764	TSKG-366	3378	112 lbs.	20			
	7'	TVKS-367	5810	TKSS-367	4763	TKMS-367	4440	TSKG-367	4391	131 lbs.	23			
	8'	TVKS-368	6119	TKSS-368	5085	TKMS-368	4741	TSKG-368	4686	145 lbs.	27			
	9'	TVKS-369	7300	TKSS-369	6742	TKMS-369	6226	TSKG-369	5921	165 lbs.	30			
	10'	TVKS-3610	7626	TKSS-3610	7058	TKMS-3610	6549	TSKG-3610	6241	268 lbs.	46			
	11'	TVKS-3611	8130	TKSS-3611	7597	TKMS-3611	7027	TSKG-3611	6640	298 lbs.	51			
	12'	TVKS-3612	8241	TKSS-3612	7704	TKMS-3612	7143	TSKG-3612	6757	313 lbs.	55			

Units 8 ft. and larger furnished with 6 legs. SPECIAL LENGTHS: Select next largest size. Add Model # TA-61 No Charge (ex. SS-306 with TA-61 size to 66" long).

SELECTED SPEC-LINE UPGRADES

TA-3	Stainless Steel Hat Channel & Gusset	579 /lin. ft.
TA-94	16 ga. S/S 304 Undersheff. (any size)	75 /lin. ft.
TA-95	18 ga. S/S 304 Legs	185 /table
TA-23	Legs Welded to Underneath or Cross-Rails, Shipped Set Up & Crated.	561 /table
TA-23A	Table Legs Welded To Leg Gussets & Undersheff or Cross-Bracing, Shipped Set Up & Crated.	741 /table

WORKTABLE CASTERS

Maintains the 35-1/2" Working Height

TA-255-4	4 Casters for Work Tables (2 w/ Brakes)	5594 /set of 4
TA-255-6	6 Casters for Work Tables (2 w/ Brakes)	897 /set of 6
TA-25	4 Casters for Open Base Tables (2 w/ Brakes)	594 /set of 4
TA-25A	6 Casters for Open Base Tables (2 w/ Brakes)	897 /set of 6

See Page 68 for More Caster Options



TVKG Series
10" Back Splash
Countertop Edge



TKLG, TKMG, TKAG Series
5" Back Splash
Bullnose Edge

TABLES

10" & 5" Rear Splash W/ Open Base



Stainless Steel TOP
Galvanized LEGS

	Spec-Line			Premium			Standard			Super Saver			Approx. Shipping Weight	Approx. Cubic Feet	
	Length	Model #	Price	Model #	Price	Model #	Price	Model #	Price	14 Ga. 304 S/S	14 Ga. 304 S/S	16 Ga. 304 S/S			16 Ga. 430 S/S
24" WIDE	2'	TVKG-242	\$2945	TKLG-242	\$1777	TKMG-242	\$1735	TKAG-242	\$1657					43 lbs.	5
	30"	TVKG-240	3099	TKLG-240	1907	TKMG-240	1870	TKAG-240	1762					49 lbs.	6
	3'	TVKG-243	3193	TKLG-243	2011	TKMG-243	1964	TKAG-243	1850					55 lbs.	7
	4'	TVKG-244	3242	TKLG-244	2059	TKMG-244	1999	TKAG-244	1896					67 lbs.	9
	5'	TVKG-245	3380	TKLG-245	2190	TKMG-245	2129	TKAG-245	1971					77 lbs.	12
	6'	TVKG-246	3542	TKLG-246	2338	TKMG-246	2265	TKAG-246	2080					89 lbs.	14
	7'	TVKG-247	4135	TKLG-247	2924	TKMG-247	2834	TKAG-247	2505					107 lbs.	16
	8'	TVKG-248	4335	TKLG-248	3112	TKMG-248	3014	TKAG-248	2780					119 lbs.	18
	9'	TVKG-249	4956	TKLG-249	3809	TKMG-249	3673	TKAG-249	3522					135 lbs.	21
	10'	TVKG-2410	5267	TKLG-2410	4125	TKMG-2410	3990	TKAG-2410	3843					234 lbs.	28
	11'	TVKG-2411	5641	TKLG-2411	4369	TKMG-2411	4219	TKAG-2411	4070					258 lbs.	36
	12'	TVKG-2412	5756	TKLG-2412	4485	TKMG-2412	4332	TKAG-2412	4182					273 lbs.	39
30" WIDE	2'	TVKG-302	2973	TKLG-302	1795	TKMG-302	1762	TKAG-302	1667					48 lbs.	6
	30"	TVKG-300	3143	TKLG-300	1964	TKMG-300	1907	TKAG-300	1784					55 lbs.	7
	3'	TVKG-303	3242	TKLG-303	2063	TKMG-303	2011	TKAG-303	1887					62 lbs.	9
	4'	TVKG-304	3319	TKLG-304	2127	TKMG-304	2068	TKAG-304	1905					75 lbs.	11
	5'	TVKG-305	3498	TKLG-305	2296	TKMG-305	2224	TKAG-305	2039					89 lbs.	14
	6'	TVKG-306	3685	TKLG-306	2467	TKMG-306	2390	TKAG-306	2164					97 lbs.	17
	7'	TVKG-307	4286	TKLG-307	3054	TKMG-307	2955	TKAG-307	2619					118 lbs.	20
	8'	TVKG-308	4549	TKLG-308	3292	TKMG-308	3192	TKAG-308	2934					131 lbs.	22
	9'	TVKG-309	5341	TKLG-309	4054	TKMG-309	3908	TKAG-309	3755					150 lbs.	25
	10'	TVKG-3010	5655	TKLG-3010	4370	TKMG-3010	4224	TKAG-3010	4070					249 lbs.	40
	11'	TVKG-3011	5974	TKLG-3011	4671	TKMG-3011	4494	TKAG-3011	4333					276 lbs.	43
	12'	TVKG-3012	6094	TKLG-3012	4784	TKMG-3012	4611	TKAG-3012	4450					291 lbs.	47
36" WIDE	2'	TVKG-362	3725	TKLG-362	2401	TKMG-362	2340	TKAG-362	2311					75 lbs.	10
	3'	TVKG-363	3766	TKLG-363	2453	TKMG-363	2386	TKAG-363	2364					80 lbs.	10
	4'	TVKG-364	3829	TKLG-364	2523	TKMG-364	2453	TKAG-364	2434					85 lbs.	14
	5'	TVKG-365	4063	TKLG-365	2867	TKMG-365	2782	TKAG-365	2622					99 lbs.	17
	6'	TVKG-366	4285	TKLG-366	3059	TKMG-366	2957	TKAG-366	2770					112 lbs.	20
	7'	TVKG-367	5004	TKLG-367	3561	TKMG-367	3449	TKAG-367	3242					131 lbs.	23
	8'	TVKG-368	5204	TKLG-368	3971	TKMG-368	3841	TKAG-368	3611					145 lbs.	27
	9'	TVKG-369	6159	TKLG-369	4869	TKMG-369	4684	TKAG-369	4540					165 lbs.	30
	10'	TVKG-3610	6476	TKLG-3610	5187	TKMG-3610	5004	TKAG-3610	4850					268 lbs.	46
	11'	TVKG-3611	6860	TKLG-3611	5531	TKMG-3611	5326	TKAG-3611	5162					298 lbs.	51
	12'	TVKG-3612	6972	TKLG-3612	5641	TKMG-3612	5435	TKAG-3612	5268					313 lbs.	55

Put a Sink in Your Table!



SINGLE & DOUBLE BOWLS AVAILABLE

For Integral Sinks
See Page 65

POLY-VANCE 5/8" THICK CUTTING BOARDS

Model #	Description	Price
K-2A	Cutting Board For 10"x14" Bowls	\$413 ea.
K-2B	Cutting Board For 14"x16" Bowls	413 ea.
K-2C	Cutting Board For 16"x20" Bowls	413 ea.
K-2D	Cutting Board For 18"x24" Bowls	413 ea.
K-2E	Cutting Board For 20"x20" Bowls	413 ea.
K-2F	Cutting Board For 24"x24" Bowls	413 ea.
K-2J	Cutting Board For 18"x18" Bowls	413 ea.
K-2K	Cutting Board For 30"x24" Bowls	413 ea.

For Faucets & Accessories - See Page 35-36 49

TABLES

Enclosed Base Tables

FLAT TOP UNITS



*Please add "M" after model number when adding Fixed Mid Shelf & refer to prices below



Open Base



Sliding Doors



Hinged Doors

L	Model #	w/ Fixed Mid-Shell (Add "M")		Model #	# of Doors	w/ Fixed Mid-Shell (Add "M")		Model #	# of Doors	w/ Fixed Mid-Shell (Add "M")		Approx. Cubic Feet
24" WIDE	3'	EB-SS-243	\$3983 M \$4755	NOT AVAILABLE				HB-SS-243	2	\$6284 M \$7060	30	
	4'	EB-SS-244	4132 M 4898	CB-SS-244	2	\$5687 M \$6458	HB-SS-244	2	6589 M 7355	38		
	5'	EB-SS-245	4425 M 5283	CB-SS-245	2	6111 M 6977	HB-SS-245	2	7022 M 7883	47		
	6'	EB-SS-246	4716 M 5687	CB-SS-246	2	6552 M 7525	HB-SS-246	4	7449 M 8418	56		
	7'	EB-SS-247	5134 M 6213	CB-SS-247	4	7491 M 8573	HB-SS-247	4	8384 M 9468	66		
	8'	EB-SS-248	5397 M 6559	CB-SS-248	4	8093 M 9263	HB-SS-248	4	8997 M 10163	74		
	9'	EB-SS-249	6113 M 7471	CB-SS-249	4	9072 M 10431	HB-SS-249	4	9977 M 11337	83		
	10'	EB-SS-2410	6393 M 7747	CB-SS-2410	4	9354 M 10704	HB-SS-2410	4	10253 M 11608	92		
	12'	EB-SS-2412	8833 M 9911	CB-SS-2412	4	11450 M 13027	HB-SS-2412	6	13850 M 15572	109		
	30" WIDE	3'	EB-SS-303	4199 M 5079	NOT AVAILABLE				HB-SS-303	2	6503 M 7302	35
4'		EB-SS-304	4351 M 5233	CB-SS-304	2	5903 M 6783	HB-SS-304	2	6795 M 7678	45		
5'		EB-SS-305	4675 M 5687	CB-SS-305	2	6368 M 7376	HB-SS-305	2	7278 M 8286	55		
6'		EB-SS-306	5012 M 6130	CB-SS-306	2	6842 M 7964	HB-SS-306	4	7748 M 8867	66		
7'		EB-SS-307	5353 M 6598	CB-SS-307	4	7697 M 8946	HB-SS-307	4	8600 M 9847	76		
8'		EB-SS-308	5911 M 7301	CB-SS-308	4	8428 M 9822	HB-SS-308	4	9329 M 10722	87		
9'		EB-SS-309	6519 M 8141	CB-SS-309	4	9470 M 11098	HB-SS-309	4	10379 M 12012	97		
10'		EB-SS-3010	6794 M 8417	CB-SS-3010	4	9746 M 11373	HB-SS-3010	4	10655 M 12290	107		
12'		EB-SS-3012	9364 M 10439	CB-SS-3012	4	12672 M 14656	HB-SS-3012	6	14578 M 16294	128		
36" WIDE		3'	EB-SS-363	4500 M 5478	NOT AVAILABLE				HB-SS-363	2	6970 M 7939	41
	4'	EB-SS-364	4644 M 5623	CB-SS-364	2	6295 M 7275	HB-SS-364	2	7266 M 8236	53		
	5'	EB-SS-365	4996 M 6131	CB-SS-365	2	6799 M 7938	HB-SS-365	2	7770 M 8909	65		
	6'	EB-SS-366	5584 M 6873	CB-SS-366	2	7307 M 8592	HB-SS-366	4	8276 M 9562	77		
	7'	EB-SS-367	5715 M 7160	CB-SS-367	4	8224 M 9673	HB-SS-367	4	9186 M 10643	90		
	8'	EB-SS-368	6314 M 7831	CB-SS-368	4	9010 M 10529	HB-SS-368	4	9965 M 11484	102		
	9'	EB-SS-369	6982 M 8881	CB-SS-369	4	10137 M 12041	HB-SS-369	4	11107 M 13001	114		
	10'	EB-SS-3610	7262 M 9162	CB-SS-3610	4	10410 M 12317	HB-SS-3610	4	11384 M 13284	126		
	12'	EB-SS-3612	9550 M 11241	CB-SS-3612	4	13442 M 15598	HB-SS-3612	6	15788 M 17701	151		

1-1/2" BACKSPASH UNITS

Open Base

Sliding Doors

Hinged Doors

L	Model #	w/ Fixed Mid-Shell (Add "M")		Model #	# of Doors	w/ Fixed Mid-Shell (Add "M")		Model #	# of Doors	w/ Fixed Mid-Shell (Add "M")		Approx. Cubic Feet
24" WIDE	3'	EF-SS-243	\$3983 M \$4755	NOT AVAILABLE				HF-SS-243	2	\$6284 M \$7060	30	
	4'	EF-SS-244	4132 M 4898	CF-SS-244	2	\$5687 M \$6458	HF-SS-244	2	6589 M 7355	38		
	5'	EF-SS-245	4425 M 5283	CF-SS-245	2	6111 M 6977	HF-SS-245	2	7022 M 7883	47		
	6'	EF-SS-246	4716 M 5687	CF-SS-246	2	6552 M 7525	HF-SS-246	4	7449 M 8418	56		
	7'	EF-SS-247	5134 M 6213	CF-SS-247	4	7491 M 8573	HF-SS-247	4	8384 M 9468	66		
	8'	EF-SS-248	5397 M 6559	CF-SS-248	4	8093 M 9263	HF-SS-248	4	8997 M 10163	74		
	9'	EF-SS-249	6113 M 7471	CF-SS-249	4	9072 M 10431	HF-SS-249	4	9977 M 11337	83		
	10'	EF-SS-2410	6393 M 7747	CF-SS-2410	4	9354 M 10704	HF-SS-2410	4	10253 M 11608	92		
	12'	EF-SS-2412	8833 M 9911	CF-SS-2412	4	11450 M 13027	HF-SS-2412	6	13850 M 15572	109		
	30" WIDE	3'	EF-SS-303	4199 M 5079	NOT AVAILABLE				HF-SS-303	2	6503 M 7381	35
4'		EF-SS-304	4351 M 5233	CF-SS-304	2	5903 M 6783	HF-SS-304	2	6795 M 7678	45		
5'		EF-SS-305	4675 M 5687	CF-SS-305	2	6368 M 7376	HF-SS-305	2	7278 M 8286	55		
6'		EF-SS-306	5008 M 6130	CF-SS-306	2	6842 M 7964	HF-SS-306	4	7748 M 8867	66		
7'		EF-SS-307	5353 M 6598	CF-SS-307	4	7697 M 8946	HF-SS-307	4	8600 M 9847	76		
8'		EF-SS-308	5911 M 7301	CF-SS-308	4	8428 M 9822	HF-SS-308	4	9329 M 10722	87		
9'		EF-SS-309	6519 M 8141	CF-SS-309	4	9470 M 11098	HF-SS-309	4	10379 M 12002	97		
10'		EF-SS-3010	6794 M 8417	CF-SS-3010	4	9746 M 11373	HF-SS-3010	4	10655 M 12282	107		
12'		EF-SS-3012	9364 M 10439	CF-SS-3012	4	12672 M 14656	HF-SS-3012	6	14578 M 16294	128		

(Approx. Shipping Weight is 50 Lbs. Per Linear Foot)

FOR 36" WIDE 1-1/2" SPLASH UNITS: Use 36" Flat Top Price and Replace "B" with "F" (Example: EB-SS-364 would change to read EF-SS-364)

For Enclosed Base Tables Over 12' Add:
 TA-65 Open Base Units \$697 /lin. ft.
 TA-66 Sliding Door Units 1015 /lin. ft.
 TA-67 Hinged Door Units 1076 /lin. ft.

TA-36D \$176 ea.
 Hinged Door
 Repair Kit



***Please add "M" after model number when adding Fixed Mid Shelf & refer to prices below**



TABLES

Enclosed Base Tables

14 GAUGE TOP



Open Base



Sliding Doors



Hinged Doors

L	Model #	w/ Fixed Mid-Shelf (Add "M")		Model #	# of Doors	w/ Fixed Mid-Shelf (Add "M")		Model #	# of Doors	w/ Fixed Mid-Shelf (Add "M")		Approx. Cubic Feet
		Price	Weight			Price	Weight			Price	Weight	
24" WIDE	3'	EK-SS-243	\$4109 M \$4803	NOT AVAILABLE			HK-SS-243	2	\$6417 M \$7191	30		
	4'	EK-SS-244	4258 M 4948	CK-SS-244	2	\$5809 M \$6589	HK-SS-244	2	6714 M 7484	38		
	5'	EK-SS-245	4557 M 5339	CK-SS-245	2	6251 M 7118	HK-SS-245	2	7149 M 8027	47		
	6'	EK-SS-246	4863 M 5751	CK-SS-246	2	6705 M 7740	HK-SS-246	4	7601 M 8580	56		
	7'	EK-SS-247	5295 M 6179	CK-SS-247	4	7645 M 8733	HK-SS-247	4	8548 M 9640	66		
	8'	EK-SS-248	5565 M 6641	CK-SS-248	4	8259 M 9425	HK-SS-248	4	9171 M 10336	74		
	9'	EK-SS-249	6311 M 7578	CK-SS-249	4	9266 M 10615	HK-SS-249	4	10165 M 11523	83		
30" WIDE	10'	EK-SS-2410	6591 M 7853	CK-SS-2410	4	9544 M 10897	HK-SS-2410	4	10443 M 11801	92		
	12'	EK-SS-2412	9048 M 10434	CK-SS-2412	4	12473 M 13982	HK-SS-2412	6	14121 M 15789	109		
	3'	EK-SS-303	4464 M 5207	NOT AVAILABLE			HK-SS-303	2	6626 M 7511	35		
	4'	EK-SS-304	4620 M 5355	CK-SS-304	2	6026 M 6904	HK-SS-304	2	6928 M 7810	45		
	5'	EK-SS-305	4858 M 5869	CK-SS-305	2	6509 M 7523	HK-SS-305	2	7411 M 8425	55		
	6'	EK-SS-306	5072 M 6193	CK-SS-306	2	6992 M 8117	HK-SS-306	4	7893 M 9015	66		
	7'	EK-SS-307	5507 M 6762	CK-SS-307	4	7858 M 9103	HK-SS-307	4	8768 M 11455	76		
36" WIDE	8'	EK-SS-308	6082 M 7470	CK-SS-308	4	8595 M 9987	HK-SS-308	4	10063 M 11529	87		
	9'	EK-SS-309	6706 M 8419	CK-SS-309	4	9667 M 11299	HK-SS-309	4	10569 M 12190	97		
	10'	EK-SS-3010	6989 M 8600	CK-SS-3010	4	9947 M 11570	HK-SS-3010	4	10845 M 12693	107		
	12'	EK-SS-3012	9547 M 10933	CK-SS-3012	4	13319 M 15094	HK-SS-3012	6	15278 M 16949	128		
	3'	EK-SS-363	4631 M 5598	NOT AVAILABLE			HK-SS-363	2	7094 M 8069	41		
	4'	EK-SS-364	4778 M 5749	CK-SS-364	2	6428 M 7401	HK-SS-364	2	7395 M 8366	53		
	5'	EK-SS-365	5108 M 6353	CK-SS-365	2	6952 M 8082	HK-SS-365	2	7909 M 9043	65		
36" WIDE	6'	EK-SS-366	5721 M 7018	CK-SS-366	2	7462 M 8748	HK-SS-366	4	8426 M 9704	77		
	7'	EK-SS-367	5881 M 7322	CK-SS-367	4	8388 M 9842	HK-SS-367	4	9359 M 10802	90		
	8'	EK-SS-368	6489 M 8007	CK-SS-368	4	9180 M 10696	HK-SS-368	4	10747 M 12268	102		
	9'	EK-SS-369	7772 M 8997	CK-SS-369	4	10337 M 12236	HK-SS-369	4	11219 M 13114	114		
	10'	EK-SS-3610	8418 M 9271	CK-SS-3610	4	10529 M 12427	HK-SS-3610	4	11492 M 13388	126		
	12'	EK-SS-3612	9922 M 11755	CK-SS-3612	4	14279 M 16080	HK-SS-3612	6	16272 M 18037	151		

(Approx. shipping weight is 75 lbs. per lineal foot)

We Recommend a Welded Field Joint For Units Over 12' TA-57 \$359 ea.

(Units over 14' require a Welded or Bolted Field Joint)

SVU ECONOMY ENCLOSED BASE TABLES

SPECIAL VALUE UNITS

- 16 Gauge, 304 Stainless Steel Top
- 18 Gauge, 430 Stainless Steel Body
- 1-5/8" Rolled Rim On front
- 1-5/8" Square Sides
- Fixed Mid Shelf
- Stainless Steel Legs & Bullet Feet

16 GAUGE TOP



L	FLAT TOP				5" BACK SPLASH				Approx. Cubic Feet	
	SLIDING DOORS	List Price	HINGED DOORS	List Price	SLIDING DOORS	List Price	HINGED DOORS	List Price		
24" WIDE	36"	N/A	EHB-SS-243M	\$6436	N/A	EHK-SS-243M	\$6571	30		
	48"	ECB-SS-244M	\$5825	EHB-SS-244M	6746	ECK-SS-244M	\$5983	EHK-SS-244M	6876	38
	60"	ECB-SS-245M	6255	EHB-SS-245M	7190	ECK-SS-245M	6402	EHK-SS-245M	7388	47
	72"	ECB-SS-246M	6712	EHB-SS-246M	7629	ECK-SS-246M	6868	EHK-SS-246M	7783	56
	84"	ECB-SS-247M	7670	EHB-SS-247M	8584	ECK-SS-247M	7828	EHK-SS-247M	8755	66
	96"	ECB-SS-248M	8287	EHB-SS-248M	9211	ECK-SS-248M	8457	EHK-SS-248M	9391	74
	108"	ECB-SS-249M	9290	EHB-SS-249M	10208	ECK-SS-249M	9491	EHK-SS-249M	10409	83
30" WIDE	120"	ECB-SS-2410M	9579	EHB-SS-2410M	10500	ECK-SS-2410M	9771	EHK-SS-2410M	10695	92
	36"	N/A	EHB-SS-303M	\$6659	N/A	EHK-SS-303M	\$6793	35		
	48"	ECB-SS-304M	\$6046	EHB-SS-304M	6959	ECK-SS-304M	\$6171	EHK-SS-304M	7094	45
	60"	ECB-SS-305M	6522	EHB-SS-305M	7455	ECK-SS-305M	6666	EHK-SS-305M	7590	55
	72"	ECB-SS-306M	7009	EHB-SS-306M	7933	ECK-SS-306M	7162	EHK-SS-306M	8083	66
	84"	ECB-SS-307M	7884	EHB-SS-307M	8808	ECK-SS-307M	8048	EHK-SS-307M	8984	76
	96"	ECB-SS-308M	8634	EHB-SS-308M	9550	ECK-SS-308M	8801	EHK-SS-308M	10315	87
30" WIDE	108"	ECB-SS-309M	9698	EHB-SS-309M	10637	ECK-SS-309M	9896	EHK-SS-309M	10822	97
	120"	ECB-SS-3010M	9980	EHB-SS-3010M	10911	ECK-SS-3010M	10186	EHK-SS-3010M	11105	107

TABLES

Enclosed Base Tables

30" Wide Units!

Featuring SHD Series NSF Drawers



ADJUSTABLE MID SHELF FOR ENCLOSED BASE TABLES

TA-116 **\$1174** Per Section

Add To Price of Enclosed Base Table with Fixed Mid Shelf (M) On Page 50 & 51.
(Shelves Over 36" in Length Require Multiple Sections With Center Partition. For Partial Shelves Add to Price of Shelf on Page 68.)



Hinged Doors



Sliding Doors

ENCLOSED BASE TABLES WITH DRAWERS

Length	w/ Hinged Door		w/ Sliding Doors		# of Drawers	# of Doors	Weight	Cubic Feet
	Model #	Price	Model #	Price				
60"	HDRC-305	\$10704	SDRC-305	\$10535	2	2	300 lbs.	55
72"	HDRC-306	11418	SDRC-306	11233	2	4	360 lbs.	66
84"	HDRC-307	13727	SDRC-307	13591	3	4	420 lbs.	76
96"	HDRC-308	13980	SDRC-308	13730	3	4	540 lbs.	87
120"	HDRC-3010	17670	SDRC-3010	17530	4	4	600 lbs.	107

MODIFICATIONS & ACCESSORIES

TA-105	Modified to 24" Width	\$428 /table	TA-14	Drawer Lock	\$196 ea.
TA-110	Modified to 36" Width	80 /lin.ft.	TA-46	Door Lock	451 ea.



DISH CABINETS



Model #	Option	Price
TA-100F	Bullnose Front Top Edge	\$155
TA-101	Rear Tray Lock	130 /lin. ft.
TA-61	Special Sizing Change (From Next Larger Size)	N/C

Length	15" WIDE				18" WIDE			
	Model #	Weight	Cu. Ft.	Price	Model #	Weight	Cu. Ft.	Price
48"	DC-154	155 lbs.	21	\$4139	DC-184	170 lbs.	25	\$4421
60"	DC-155	195 lbs.	27	4426	DC-185	205 lbs.	31	4778
72"	DC-156	225 lbs.	32	4921	DC-186	245 lbs.	36	5853
84"	DC-157	265 lbs.	37	5130	DC-187	275 lbs.	41	6316
96"	DC-158	295 lbs.	42	5510	DC-188	315 lbs.	46	6795
120"	DC-1510	360 lbs.	52	6764	DC-1810	385 lbs.	56	7687
144"	DC-1512	400 lbs.	62	6963	DC-1812	425 lbs.	66	7894

30" Wide Units!



BEVERAGE TABLES



Length	Model #	Price	Weight	Cu. Ft.
4'	BEV-30-48LorR*	\$9258	230 lbs.	37
5'	BEV-30-60LorR*	9830	250 lbs.	45
6'	BEV-30-72LorR*	10449	270 lbs.	54
7'	BEV-30-84LorR*	11965	290 lbs.	63
8'	BEV-30-96LorR*	12722	330 lbs.	71
9'	BEV-30-108LorR*	19103	360 lbs.	76
10'	BEV-30-120LorR*	19172	380 lbs.	88
12'	BEV-30-144LorR*	19412	430 lbs.	90

Specify Sink Left Or Right End:

*Please Designate Left Or Right Sink Location By Using L Or R After Model Number When Ordering.

Sink Size 14" x 16" x 12"

Customize Your Own Beverage Table with Additional Accessories on Pages 61-68
TA-45 Optional Glass Rack Slide **\$862**

Call For Installation of Buyout Equipment!

Ship Via UPS

SINK CABINETS

Sink Cabinets

SELF-CONTAINED MOBILE HAND SINKS



Bring The Sink On Location When Hand Washing Is Needed!

- 16 Ga., 304 Stainless Steel Top.
- K-52 Deck Mt. Goose-neck Faucet.
- Door Latch.
- 4" Plate Casters - 2 with Brakes.
- Hinged Door.
- Operates on a 120 Volt/15 Amp Circuit.
- 2-1/2 Gallon Electric Hot Water Heater (See Models Below).
- 6 Ft. Power Cord.
- Removable Plastic Container(s) for Fresh Water.
- Removable Plastic Container(s) for Waste Water.



SHK-MSC-26C Shown

w/ Cold Water Supply Only				w/ Hot & Cold Water Supply				Size L x W	Sink Bowl	Capacity (Gal.) Fresh/Waste
Model #	Dry Weight	Cu. Ft.	Price	Model #	Dry Weight	Cu. Ft.	Price			
SHK-MSC-26C	165 lbs.	21	\$9823	SHK-MSC-26CH	175 lbs.	21	\$10429	26" x 26"	10" x 14" x 5"	5/7
SHK-MSC-31C	185 lbs.	25	10166	SHK-MSC-31CH	195 lbs.	25	11037	31" x 26"	10" x 14" x 5"	10/14

SELF-CONTAINED MOBILE HAND SINK ACCESSORIES & MODIFICATIONS



TA-MSC-1 Shown



TA-MSC-ES1 Shown

TA-MSC-1	Boil-on Towel/Manual Soap Dispenser w/ Drip Tray for 26" Unit	\$999
TA-MSC-2	Boil-on Towel/Manual Soap Dispenser w/ Drip Tray for 31" Unit	1327
TA-MSC-ES1	Boil-on Towel/Touchless Soap Dispenser w/ Drip Tray for 26" Unit	1293
TA-MSC-ES2	Boil-on Towel/Touchless Soap Dispenser w/ Drip Tray for 31" Unit	1650
TA-MSC-PC	10 Ft. Power Cord	358
TA-46	Door Lock	451
K-12	Deck Mounted Soap Dispenser	211
K-316-LU	Wrist Handles For Faucet	167

CORNER SINK CABINET



- Furnished With A 5" Splash With A 1" Return.
- SHK-2441 Designed To Line Up With "HK" 5" Rear Splash Enclosed Base Tables To Create Functional Work Area.
- Door Is A Double Panel Design.

- Utility Access Clearance Provided For Ease Of Plumbing Installation.
- Includes Sink With K-124 6" Extended Spout Faucet & Drain.
- Mitered Front Permits Easy Access To Sink Bowl & Faucet.



SHK-2441 Shown with Enclosed Base Line-Up.
For Enclosed Base Table Options, See Pages 61-65.

Model #	Size		Sink Bowl	Weight	Cu. Ft.	Price
	L x W	L x W				
SHK-1735	17" x 35"	14" x 10" x 10"	215 lbs.	38	\$7604	
SHK-2441	24" x 41"	16" x 20" x 12"	250 lbs.	50	8368	

STANDARD SINK CABINET



- 5" Splash With A 1" Return On The Rear Side.
- Includes Sink And K-124 6" Extended Faucet & Drain.
- Hinged Door.

Model #	Size L x W	Sink Bowl	Dry Weight	Cu. Ft.	Price
SHK-302	24" x 30"	10" x 14" x 10"	150 lbs.	30	\$6655
Space Saver Sink Cabinet					
SHK-180	18" x 30"	10" x 14" x 10"	125 lbs.	30	6086



Add a 5" SIDE SPLASH
TA-31 \$242 ea.

WARNING: Equipment that includes a faucet may expose you to chemicals, including lead, that are known to the State of California to cause cancer or birth defects or other reproductive harm. For more info, visit www.p66warnings.ca.gov

WALL CABINETS

Wall Cabinets

15" WIDE STAINLESS STEEL WALL CABINETS

18 Gauge, 430 Stainless Steel Includes Fixed Mid-Shelf



SLIDING DOOR



OPEN UNIT



HINGED DOORS



Size L x W x H	W/ SLIDING DOORS				OPEN UNIT			W/ HINGED DOORS				Approx. Cu. Ft.
	Model #	Price	Doors	Approx. Weight	Model #	Price	Approx. Weight	Model #	Price	Doors	Approx. Weight	
36" x 15" x 32-1/2"	WCS-15-36	\$6983	2	130 lbs.	WCO-15-36	\$4982	95 lbs.	WCH-15-36	\$7341	2	120 lbs.	17
48" x 15" x 32-1/2"	WCS-15-48	7473	2	155 lbs.	WCO-15-48	5739	120 lbs.	WCH-15-48	7954	2	150 lbs.	21
60" x 15" x 32-1/2"	WCS-15-60	8638	2	185 lbs.	WCO-15-60	6265	145 lbs.	WCH-15-60	9107	2	180 lbs.	26
72" x 15" x 32-1/2"	WCS-15-72	9383	2	220 lbs.	WCO-15-72	7575	180 lbs.	WCH-15-72	9329	4	240 lbs.	31
84" x 15" x 32-1/2"	WCS-15-96	11790	4	295 lbs.	WCO-15-96	8121	240 lbs.	WCH-15-96	10550	4	320 lbs.	41

STORAGE CABINETS



84" High Storage Cabinet w/ 4 Fixed Mid-Shelves

- Single Left-Hinged Door*
- 4 Fixed Stainless Steel Mid-Shelves
- Enclosed Back Panel
- Ventilation Slots

Overall Size: 25" L x 22-5/8" W x 84" H

CAB-4 \$8533

18 Gauge, 430 Stainless Steel

CAB-4-300 \$9368

18 Gauge, 300 Stainless Steel

*Optional Right-Hand Door Swing Available - Add CAB-R N/C



Wall Mounted Chemical Storage Cabinet w/ 1 Fixed Mid-Shelf

- Left-Hinged Door*
- Vented Side Panels
- Mounting Hardware Not Included

Overall Size: 24" L x 15" W x 32-1/2" H

WCH-15-24 \$6191

18 Gauge, 430 Stainless Steel

WCH-15-24-300 \$6860

18 Gauge, 300 Stainless Steel

CABINET ACCESSORIES & MODIFICATIONS



Adjustable Mid-Shelf

TA-115 \$195 per lin. ft.

Add to Price of 84" High Storage Cabinets or Wall Cabinets



Additional Fixed Mid-Shelf

WC-SHELF \$125 per lin. ft. K-94-SHELF \$521 ea.

For WCS, WCO, WCH Series Wall Cabinets For 84" High Storage Cabinet



Cabinet Door Lock

SU-27 \$451

One Per Hinged Door or Pair of Sliding Doors

STAINLESS STEEL WALL FLASHING

- Wall Flashing Supplied in 10' Lengths
- Type 304 Stainless Steel
- Polished to a Commercial Grade #3 Finish



Model #	Gauge	Price
WF20	20	\$112 sq/ft.

Optional Accessories		
Model #	Style	Price
WF-EC-1	Edge Cap	\$176 ea.
WF-SC-1	Seam Cap	\$176 ea.
WF-IC-1	Inside Corner Cap	\$197 ea.



SPECIALTY TABLES

DEMO TABLE

Countertop Edge Mirror Tilts to Desired Position



Model #	Table Size	Mirror Size	Wt.	Cu.	Price
VSS-DT-365	36" x 60"	24" x 48"	275 lbs.	18	\$11252
VSS-DT-366	36" x 72"	24" x 60"	305 lbs.	23	13247

CEILING MOUNTED DEMO MIRROR

- 16 ga. type 304 Stainless Steel
- 1 5/8" Tubing - 4" Posts
- 14 ga. Rainbow Uprights For Added Support
- Glass Mirror



Model #	Mirror Size	Wt.	Cu.	Price
MI-48	24" x 48"	91 lbs.	7	\$6324
MI-60	24" x 60"	115 lbs.	8	7421

Mirror Tilts to Desired Position

PRINT REQUIRED

CORNER TABLES 14 Gauge, 304 Stainless Steel 5" Rear Splash (1" Return)

Length	24" WIDE		30" WIDE		Wt.	Cu. Ft.
	Model #	Price	Model #	Price		
5'	KTMS-245	\$9596	KTMS-305	\$9794	280 lbs.	30
6'	KTMS-246	9794	KTMS-306	9988	300 lbs.	35
7'	KTMS-247	9988	KTMS-307	10185	320 lbs.	40
8'	KTMS-248	10185	KTMS-308	10379	345 lbs.	45
9'	KTMS-249	10379	KTMS-309	10577	375 lbs.	50
10'	KTMS-2410	10577	KTMS-3010	10773	400 lbs.	55
11'	KTMS-2411	10773	KTMS-3011	10967	425 lbs.	60
12'	KTMS-2412	11164	KTMS-3012	11359	450 lbs.	65

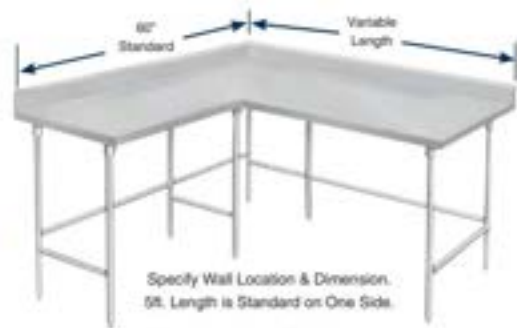

Specify Wall Location & Dimension. St. Length is Standard on One Side.

(Length can be modified, but not to exceed 7 ft. on one wall dimension)

TA-57 \$320 Prepare Welded Field Joint

Accessories

KT-100	36" Width On Corner Tables	\$202 /lin. ft.	KT-103	Stainless Steel Undersheff	\$85 /lin. ft.
KT-101	Additional Length in Excess of 5'	238 /lin. ft.	KT-104	Stainless Steel Cabinet Base	512 /lin. ft.
KT-102	Special Sizing Charge	N/C		(Top Is Shipped Separately For Ease In Installation)	

WORK TABLE WITH PREP SINK & FAUCET



KMS-11B-305R Shown

- 16 ga., 304 Stainless Steel Top
- 5" Rear Splash
- 16" x 20" x 12" Sink Bowl
- Stainless Steel Adjustable Undersheff
- 4 O.C. Deck Mounted Faucet & Basket Drain Included
- Stainless Steel Legs & Bullet Feet

Size	Model #	Sink Location	Price
30" x 48"	KMS-11B-304L	Left	\$4517
30" x 48"	KMS-11B-304R	Right	4517
30" x 60"	KMS-11B-305L	Left	4744
30" x 60"	KMS-11B-305R	Right	4744
30" x 72"	KMS-11B-306L	Left	4958
30" x 72"	KMS-11B-306R	Right	4958

CHOOSE LEFT OR RIGHT SINK POSITION

PREP TABLE WITH COUNTERTOP EDGE



- 10" Rear Splash
- Includes 1 - 16" x 20" x 8" & 1 - 16" x 20" x 4" Integrally Welded Stainless Steel Sinks
- 21" x 18" x 5/8" Poly-Vance Cutting Board
- Stainless Steel Die-Formed Drawer
- Includes K-55 4" O.C. Gooseneck Faucet.

Model #	Size	Weight	Cu. Ft.	Price
DL-30-72	30" x 72"	155 lbs.	36	\$8612
DL-30-96	30" x 96"	198 lbs.	47	9607

See Page 65 For Additional Integral Sink Sizes

WARNING: Equipment that includes a faucet may expose you to chemicals, including lead, that are known to the State of California to cause cancer or birth defects or other reproductive harm. For more info, visit www.p66warnings.ca.gov

MIXER TABLES



Ship Via UPS

MIXER TABLE WITH UTENSIL RACK

24" Work Height to Top of Table (Utensil Rack Has Height of 78")

Size	Stainless Steel Base		Galvanized Base		Wt.	Cu. Ft.
24" x 24"	MX-SS-242	\$2800	MX-GL-242	\$2429	53 lbs.	3
24" x 30"	MX-SS-302	2897	MX-GL-302	2481	63 lbs.	4
30" x 30"	MX-SS-300	3110	MX-GL-300	2651	70 lbs.	5
30" x 36"	MX-SS-303	3153	MX-GL-303	2687	77 lbs.	6
36" x 36"	MX-SS-363	3238	MX-GL-363	2773	81 lbs.	7

MX-SS-242
Shown
Mixer Not Included



MIXER TABLE WITH UNDERSHELF

24" Work Height

Size	Stainless Steel Base		Galvanized Base		Wt.	Cu. Ft.
24" x 24"	MT-SS-242	\$1675	MT-GL-242	\$1377	45 lbs.	3
24" x 30"	MT-SS-302	1760	MT-GL-302	1438	50 lbs.	4
30" x 30"	MT-SS-300	1995	MT-GL-300	1603	55 lbs.	5
30" x 36"	MT-SS-303	2026	MT-GL-303	1647	68 lbs.	6
36" x 36"	MT-SS-363	2124	MT-GL-363	1722	71 lbs.	7

MT-SS-242
Shown



BUDGET MIXER TABLES

24" Work Height

Size	Stainless Steel Base		Galvanized Base		Wt.	Cu. Ft.
24" x 24"	SAG-MT-242	\$1516	AG-MT-242	\$1230	38 lbs.	3
24" x 30"	SAG-MT-302	1592	AG-MT-302	1263	41 lbs.	4
30" x 30"	SAG-MT-300	1625	AG-MT-300	1289	52 lbs.	5
30" x 36"	SAG-MT-303	1733	AG-MT-303	1354	58 lbs.	6
36" x 36"	SAG-MT-363	1827	AG-MT-363	1445	64 lbs.	7

AG-MT-242
Shown



MOBILE MIXER TABLES WITH TRAY SLIDES & CASTERS

28" Work Height. Tray Slides Have 2" Spacing

Size	Stainless Steel Base		Galvanized Base		Wt.	Cu. Ft.
30" x 30"	MT-MS-300	\$2949	MT-MG-300	\$2560	85 lbs.	9
30" x 36"	MT-MS-303	2987	MT-MG-303	2606	95 lbs.	10

MT-MG-300
Shown



MIXER EQUIPMENT TABLE

28" Work Height

Size	Model #	Price	Wt.	Cu. Ft.
24" x 30"	AG-MP-30	\$2508	65 lbs.	4

Add 15" x 20" Drawer SS-1520 \$791

Shown with
Optional Drawer



CASTERS

MAINTAINS 24" WORKING HEIGHT
5" Swivels Each Set with 2 Brakes

For Use with
Stainless Steel Legs

For Use with
Galvanized Legs

TA-25ES \$594 set/4

TA-25EG \$594 set/4

WALL MOUNTED TABLES

Must Be Installed in Cinder Block Wall
Or Equal For Necessary Support



- Rolled Rim
- 1 1/2" Backsplash

56

Length	Model #	Price
30"	FSS-W-240	\$2130
24"	FSS-W-242	1933
36"	FSS-W-243	2130
48"	FSS-W-244	2309
60"	FSS-W-245	2521
72"	FSS-W-246	2717
84"	FSS-W-247	3659
96"	FSS-W-248	3908

24"
WIDE

Length	Model #	Price
30"	FSS-W-300	\$2240
24"	FSS-W-302	2012
36"	FSS-W-303	2307
48"	FSS-W-304	2476
60"	FSS-W-305	2721
72"	FSS-W-306	2960
84"	FSS-W-307	3809
96"	FSS-W-308	4203

30"
WIDE



Ship Via UPS

STANDS

Equipment Stands

EQUIPMENT STANDS WITH UNDERSHELF



24" Working Height • 14 Ga. Type 304 Series • Up to 1000 lb. Load Capacity



Optional Heavy Duty Casters
 TA-255 Set of 4 **\$791**
 TA-256 Set of 6 **1047**
 Each set supplied with 2 Brakes

Length	Stainless Steel				Galvanized				Wt.	Cu. Ft.
	24" WIDE	Price	30" WIDE	Price	24" WIDE	Price	30" WIDE	Price		
2'	ES-242	\$1795	ES-302	\$1879	EG-242	\$1573	EG-302	\$1610	43 lbs.	4
3'	ES-243	1993	ES-303	2105	EG-243	1736	EG-303	1800	56 lbs.	6
4'	ES-244	2184	ES-304	2342	EG-244	1951	EG-304	2002	74 lbs.	8
5'	ES-245	2382	ES-305	2585	EG-245	2063	EG-305	2206	84 lbs.	9
6'	ES-246	2577	ES-306	2815	EG-246	2226	EG-306	2402	102 lbs.	11
7'	ES-247	3214	ES-307	4315	EG-247	2728	EG-307	3747	120 lbs.	13
8'	ES-248	3286	ES-308	4390	EG-248	2796	EG-308	3820	135 lbs.	15

For 36" Wide Equipment Stands Add TA-59 \$373 per table

EQUIPMENT STANDS WITH UNDERSHELF & CASTERS



24" Working Height • 14 Ga. Type 304 Stainless Steel • Up to 1000 lb. Load Capacity



Length	30" WIDE	Price	Wt.	Cu. Ft.
2'	ES-302C	\$2611	51 lbs.	4
3'	ES-303C	2835	68 lbs.	6
4'	ES-304C	3066	85 lbs.	8
5'	ES-305C	3300	102 lbs.	9
6'	ES-306C	3522	119 lbs.	11

MOBILE MACHINE STAND WITH WELDED SET-UP

14 Ga. Type 304 Stainless Steel



- Square Edge On All Four Sides
- 25" W x 30" L x 20" H
- 1 5/8" Stainless Steel Legs with Heavy Duty Casters and Brakes
- Welded Undershef

MT-SS-250C
\$2686



Optional Equipment Stand Accessories



Wood Top Cutting Board w/ Plate Shelf Shown*

*Must Order Cutting Board When Ordering Plate Shelf

L	Adj. Wood Cutting Board		Adj. S/S Plate Shelf		Wt.	Cu. Ft.
	Model #	Price	Model #	Price		
2'	TA-922	\$713	TA-962	\$690	28 lbs.	1
3'	TA-923	807	TA-963	780	30 lbs.	2
4'	TA-924	905	TA-964	861	34 lbs.	3
5'	TA-925	1002	TA-965	955	37 lbs.	3
6'	TA-926	1104	TA-966	1044	40 lbs.	4
7'	TA-927	1296	TA-967	1297	56 lbs.	5
8'	TA-928	1482	TA-968	1510	64 lbs.	5

EQUIPMENT FILLER TABLES

- Heavy Gauge Stainless Steel
- 1-1/2" Backsplash
- Stainless Steel Legs
- Stainless Steel Adjustable Bullet Feet



Size	Model #	Price	Wt.	Cu. Ft.
12" x 24"	TFMS-122	\$1286	22 lbs.	2
12" x 30"	TFMS-120	1396	31 lbs.	2
12" x 36"	TFMS-123	1482	39 lbs.	2
15" x 24"	TFMS-152	1414	25 lbs.	2
15" x 30"	TFMS-150	1541	33 lbs.	2
15" x 36"	TFMS-153	1630	41 lbs.	3
18" x 24"	TFMS-182	1425	27 lbs.	2
18" x 30"	TFMS-180	1559	35 lbs.	3
18" x 36"	TFMS-183	1610	43 lbs.	3



All Filler Tables Must Be Placed Between 2 Other Pieces Of Equipment For Stability.

w/ Adjustable Stainless Steel Undershef

Size	Model #	Price	Wt.	Cu. Ft.
15" x 24"	TFMSU-152	\$1505	28 lbs.	2
15" x 30"	TFMSU-150	1595	36 lbs.	2
15" x 36"	TFMSU-153	1705	41 lbs.	3
18" x 24"	TFMSU-182	1542	38 lbs.	2
18" x 30"	TFMSU-180	1637	41 lbs.	3
18" x 36"	TFMSU-183	1745	52 lbs.	3



WOOD TOPS

Wood Top Bakers Tables

FLAT TOP - OPEN BASE STYLE



All Wood Top Bakers Tables On Page 58 & 59 Feature 1-3/4" Thick Wood Top

= Ship Via UPS



Stainless Steel Base

L	24" WIDE	Price	Wt. (lbs.)	Cu. Ft.	30" WIDE	Price	Wt. (lbs.)	Cu. Ft.	36" WIDE	Price	Wt. (lbs.)	Cu. Ft.
4'	TH2S-244	\$1713	80	6	TH2S-304	\$1961	100	7	TH2S-364	\$2609	115	8
5'	TH2S-245	1918	95	7	TH2S-305	2235	120	9	TH2S-365	2974	135	11
6'	TH2S-246	2135	115	9	TH2S-306	2506	140	11	TH2S-366	3347	155	13
7'	TH2S-247	2627	135	10	TH2S-307	3144	155	12	TH2S-367	4189	180	15
8'	TH2S-248	2666	155	12	TH2S-308	3502	185	14	TH2S-368	4552	215	17

Galvanized Base

L	24" WIDE	Price	Wt. (lbs.)	Cu. Ft.	30" WIDE	Price	Wt. (lbs.)	Cu. Ft.	36" WIDE	Price	Wt. (lbs.)	Cu. Ft.
4'	TH2G-244	\$1346	80	6	TH2G-304	\$1505	100	7	TH2G-364	\$1800	115	8
5'	TH2G-245	1488	95	7	TH2G-305	1697	120	9	TH2G-365	2003	135	11
6'	TH2G-246	1630	115	9	TH2G-306	1881	140	11	TH2G-366	2196	155	13
7'	TH2G-247	1984	135	10	TH2G-307	2345	155	12	TH2G-367	2883	180	15
8'	TH2G-248	2338	155	12	TH2G-308	2712	185	14	TH2G-368	2923	215	17

FLAT TOP - WITH ADJUSTABLE UNDERSHELF

Stainless Steel Base

L	24" WIDE	Price	Wt. (lbs.)	Cu. Ft.	30" WIDE	Price	Wt. (lbs.)	Cu. Ft.	36" WIDE	Price	Wt. (lbs.)	Cu. Ft.
3'	H2S-243	\$1713	75	4	H2S-303	\$1954	90	5	H2S-363	\$2578	105	6
4'	H2S-244	1821	95	6	H2S-304	2068	115	7	H2S-364	2682	135	8
5'	H2S-245	2068	110	7	H2S-305	2367	140	9	H2S-365	3083	160	11
6'	H2S-246	2309	130	9	H2S-306	2675	160	11	H2S-366	3473	185	13
7'	H2S-247	2866	150	10	H2S-307	3368	185	12	H2S-367	4381	215	15
8'	H2S-248	3225	180	12	H2S-308	3727	215	14	H2S-368	4744	255	17

Galvanized Base

L	24" WIDE	Price	Wt. (lbs.)	Cu. Ft.	30" WIDE	Price	Wt. (lbs.)	Cu. Ft.	36" WIDE	Price	Wt. (lbs.)	Cu. Ft.
3'	H2G-243	\$1406	75	4	H2G-303	\$1563	90	5	H2G-363	\$1859	105	6
4'	H2G-244	1511	95	6	H2G-304	1668	115	7	H2G-364	1969	135	8
5'	H2G-245	1701	110	7	H2G-305	1895	140	9	H2G-365	2210	160	11
6'	H2G-246	1885	130	9	H2G-306	2121	160	11	H2G-366	2452	185	13
7'	H2G-247	2312	150	10	H2G-307	2682	185	12	H2G-367	3010	215	15
8'	H2G-248	2672	180	12	H2G-308	3043	215	14	H2G-368	3368	255	17



COVED TOP W/ 4" SPLASH - OPEN BASE STYLE

Stainless Steel Base

Length	30" WIDE	Price	Wt.	Cu. Ft.	36" WIDE	Price	Wt.	Cu. Ft.
4'	TBS-304	\$3846	120	12	TBS-364	\$5055	120	14
5'	TBS-305	4104	150	15	TBS-365	5410	150	18
6'	TBS-306	4815	180	18	TBS-366	6172	180	21
7'	TBS-307	5839	210	21	TBS-367	7703	210	24
8'	TBS-308	6191	240	24	TBS-368	8061	240	28

Galvanized Base

Length	30" WIDE	Price	Wt.	Cu. Ft.	36" WIDE	Price	Wt.	Cu. Ft.
4'	TBG-304	\$2919	120	12	TBG-364	\$3846	120	14
5'	TBG-305	3123	150	15	TBG-365	4136	150	18
6'	TBG-306	3751	180	18	TBG-366	4956	180	21
7'	TBG-307	4788	210	21	TBG-367	6338	210	24
8'	TBG-308	5144	240	24	TBG-368	6696	240	28

Features Coved Risers & Allow For Easy Cleaning



For Special Sizes & Configurations Of Wood Top Tables, Consult Factory.

For Additional Accessories & Modifications See Page 61 - 68 for Details



Covered Risers & Allow For Easy Cleaning!



WOOD TOPS

Wood Top Tables

COVERED TOP W/ 4" SPLASH & ADJUSTABLE UNDERSHELF



Stainless Steel Base

L	30" WIDE				36" WIDE			
	Price	Wt.	Fl.	Cu.	Price	Wt.	Fl.	Cu.
4'	BS-304	\$4018	190	15	BS-364	\$5228	190	17
5'	BS-305	4323	185	18	BS-365	5628	220	21
6'	BS-306	4946	225	21	BS-366	6536	265	25
7'	BS-307	6181	240	25	BS-367	8056	290	29
8'	BS-308	6536	275	28	BS-368	8411	350	33

Galvanized Base

L	30" WIDE				36" WIDE			
	Price	Wt.	Fl.	Cu.	Price	Wt.	Fl.	Cu.
4'	BG-304	\$3091	160	15	BG-364	\$4018	190	17
5'	BG-305	3343	185	18	BG-365	4343	220	21
6'	BG-306	4015	225	21	BG-366	5226	265	25
7'	BG-307	5136	240	25	BG-367	6684	290	29
8'	BG-308	5493	275	28	BG-368	7043	350	33

COVERED TOP W/ 4" SPLASH & 3-TIER DRAWERS



BST-306L Shown

Stainless Steel Base

L	30" WIDE				36" WIDE			
	Price	Wt.	Fl.	Cu.	Price	Wt.	Fl.	Cu.
4'	BST-304LorR	\$6405	365	46	BST-364LorR	\$8444	390	54
5'	BST-305LorR	6821	400	56	BST-365LorR	8864	430	66
6'	BST-306LorR	7352	440	67	BST-366LorR	9560	475	78
7'	BST-307LorR	7802	465	77	BST-367LorR	10828	505	91
8'	BST-308LorR	8158	500	87	BST-368LorR	11210	560	103

Galvanized Base

L	30" WIDE				36" WIDE			
	Price	Wt.	Fl.	Cu.	Price	Wt.	Fl.	Cu.
4'	BGT-304LorR	\$5551	365	46	BGT-364LorR	\$7260	390	54
5'	BGT-305LorR	5757	400	56	BGT-365LorR	7491	430	66
6'	BGT-306LorR	6431	440	67	BGT-366LorR	8273	475	78
7'	BGT-307LorR	7535	465	77	BGT-367LorR	9570	505	91
8'	BGT-308LorR	7893	500	87	BGT-368LorR	10022	560	103

COUNTERTOPS

Stainless Steel Countertops



- 16 Gauge Type 304 S/S
- #4 Satin Finish
- No-Drip "Mirror Hi-Lite Polish" Edge
- Stud Welded Hat Channel
- Sound Deadening

Countertop Shown with Optional Side Splash & Sink Bowl



Size	Flat Top			5" Backsplash			10" Backsplash					
	Price	Approx. Wt.	Approx. Cu. Ft.	Price	Approx. Wt.	Approx. Cu. Ft.	Price	Approx. Wt.	Approx. Cu. Ft.			
28" x 30"	VCTC-240	\$1716	28 lbs.	4	VCTF-240	\$1927	28 lbs.	4	VKCT-240	\$2144	28 lbs.	4
25" x 36"	VCTC-243	1716	39 lbs.	5	VCTF-243	1927	39 lbs.	5	VKCT-243	2144	39 lbs.	5
25" x 48"	VCTC-244	1895	49 lbs.	6	VCTF-244	2116	49 lbs.	6	VKCT-244	2358	49 lbs.	6
28" x 60"	VCTC-245	2085	58 lbs.	8	VCTF-245	2303	58 lbs.	8	VKCT-245	2563	58 lbs.	8
25" x 72"	VCTC-246	2265	68 lbs.	9	VCTF-246	2503	68 lbs.	9	VKCT-246	2780	68 lbs.	9
25" x 84"	VCTC-247	2802	85 lbs.	11	VCTF-247	2999	85 lbs.	11	VKCT-247	3333	85 lbs.	11
25" x 96"	VCTC-248	3004	95 lbs.	12	VCTF-248	3213	95 lbs.	12	VKCT-248	3562	95 lbs.	12
25" x 120"	VCTC-2410	4113	201 lbs.	26	VCTF-2410	4381	201 lbs.	26	VKCT-2410	4865	201 lbs.	26
30" x 30"	VCTC-300	1845	38 lbs.	5	VCTF-300	2025	38 lbs.	5	VKCT-300	2251	38 lbs.	5
30" x 36"	VCTC-303	1845	45 lbs.	6	VCTF-303	2025	45 lbs.	6	VKCT-303	2251	45 lbs.	6
30" x 48"	VCTC-304	2044	57 lbs.	8	VCTF-304	2255	57 lbs.	8	VKCT-304	2521	57 lbs.	8
30" x 60"	VCTC-305	2275	69 lbs.	9	VCTF-305	2493	69 lbs.	9	VKCT-305	2770	69 lbs.	9
30" x 72"	VCTC-306	2563	78 lbs.	11	VCTF-306	2720	78 lbs.	11	VKCT-306	3025	78 lbs.	11
30" x 84"	VCTC-307	2954	95 lbs.	13	VCTF-307	3142	95 lbs.	13	VKCT-307	3493	95 lbs.	13
30" x 96"	VCTC-308	3196	107 lbs.	15	VCTF-308	3220	107 lbs.	15	VKCT-308	3860	107 lbs.	15
30" x 120"	VCTC-3010	4590	235 lbs.	32	VCTF-3010	4694	235 lbs.	32	VKCT-3010	5226	235 lbs.	32

For Residential Finish & Packaging, Add K-350 \$503

See Pages 61 - 68 For Additional Accessories

POLY TOPS

Poly Top Bakers Tables



FLAT TOP Tubular Base



Length	24" WIDE	Price	30" WIDE	Price	Wt.	Cu. Ft.
4'	TSPT-244	\$2188	TSPT-304	\$2369	77 lbs.	8
5'	TSPT-245	2396	TSPT-305	2563	89 lbs.	9
6'	TSPT-246	3199	TSPT-306	3389	117 lbs.	11
7'	TSPT-247	3565	TSPT-307	3900	130 lbs.	13
8'	TSPT-248	3930	TSPT-308	4076	141 lbs.	15
9'	TSPT-249	4154	TSPT-309	4381	180 lbs.	17
10'	TSPT-2410	4492	TSPT-3010	4612	201 lbs.	19

With Undershef



Length	24" WIDE	Price	30" WIDE	Price	Wt.	Cu. Ft.
4'	SPT-244	\$2344	SPT-304	\$2506	89 lbs.	8
5'	SPT-245	2549	SPT-305	2717	102 lbs.	9
6'	SPT-246	3325	SPT-306	3562	125 lbs.	11
7'	SPT-247	3716	SPT-307	4039	141 lbs.	13
8'	SPT-248	4070	SPT-308	4387	168 lbs.	15
9'	SPT-249	4308	SPT-309	4535	196 lbs.	16
10'	SPT-2410	4644	SPT-3010	4767	230 lbs.	17

6" BACKSPASH Tubular Base



Length	24" WIDE	Price	30" WIDE	Price	Wt.	Cu. Ft.
4'	TSPS-244	\$2195	TSPS-304	\$2344	87 lbs.	12
5'	TSPS-245	2420	TSPS-305	2585	101 lbs.	15
6'	TSPS-246	3226	TSPS-306	3449	131 lbs.	18
7'	TSPS-247	3699	TSPS-307	4007	145 lbs.	21
8'	TSPS-248	4034	TSPS-308	4335	160 lbs.	24
9'	TSPS-249	4263	TSPS-309	4550	210 lbs.	16
10'	TSPS-2410	4527	TSPS-3010	4655	235 lbs.	17

With Undershef



Length	24" WIDE	Price	30" WIDE	Price	Wt.	Cu. Ft.
4'	SPS-244	\$2493	SPS-304	\$2657	99 lbs.	12
5'	SPS-245	2834	SPS-305	2895	113 lbs.	15
6'	SPS-246	3672	SPS-306	3748	143 lbs.	18
7'	SPS-247	4167	SPS-307	4309	167 lbs.	21
8'	SPS-248	4508	SPS-308	4586	175 lbs.	24
9'	SPS-249	4578	SPS-309	4852	225 lbs.	25
10'	SPS-2410	4833	SPS-3010	4963	242 lbs.	28

ACCESSORIES

TA-41	Replacement Poly-Vance 5/8" Cutting Board	\$131 /sq. ft.
TA-63	Removable Shelving (in Addition To Standard Shelf)	552 /table
TA-82	Scrap Chute	350 ea.
SHD-2020	Enclosed Drawers - See Page 66 For Details	1541 ea.



TA-84C Shown

KNIFE RACKS

TA-84A	Rolled Rim Type	\$512
TA-84B	Poly Table Type	512
TA-84C	Square Edge Type	512



17 Years in a Row!

TABLE MODS

Smart Table Modifications

TOP MODIFICATIONS



TA-56
5" NSF Partition



TA-523
Drop-In Urn Trough



CDR-5
Condiment Holder



TA-84
Pass-Thru



TA-108
Grommet For Cords

CDR-5	Condiment Holder (Accommodates 5 Bins)	\$1150
TA-1	Notch Backsplash For Roll Up Door w/ Pass-Thru	208
TA-3	Stainless Steel Hat Channel & Gusset Upgrade	79 /lin. ft.
TA-7	10" Partial Splash	111 /lin. ft.
TA-8	Column Notch in Rear Splash (Includes Splash)	1015 ea.
TA-10	5" Partial Splash	94 /lin. ft.
TA-12	Countertop Edge	934 /table
TA-22	Square Edge Table	N/C
TA-28	Cut-Out For Cold Well. Includes Louvered Doors	2158 /cut out
TA-29	16 Ga. 304 Rear Splash Capping Strip with Adhesive Backing	92 /lin. ft.
TA-30	1-1/2" Side Splash	130 ea.
TA-30A	1-1/2" Turn Up For Table Tops	59 /lin. ft.
TA-31	5" Side Splash	242 ea.
TA-32	10" Side Splash	474 ea.
TA-34	Top Cut-Out for Drop-In Style Units	355 /cut out
TA-34A	Top Cut-Out for Undermount Well	596 /cut out
TA-35	Splash Cut-Out	257 /cut out
TA-41	Poly-Vance 58" Cutting Board	131 /sq. ft.
TA-56	5" NSF Partition	650
TA-56A	18" NSF Partition	936
TA-57	Prepare Welded Field Joint (Welded in field by others)	359 ea.
TA-57A	Bolted Field Joint (Bolted in field by others)	759 ea.
TA-57B	Hairline Bolted Field Joint	1016 ea.
TA-58	Stepdown to 24" Working Height	1603 ea.
TA-64	Urn Trough (Factory installation only)	218 /lin. ft.
TA-75	Mitered Edge	1040 ea.
TA-76	Paint on Sound Deadening	746 /table
TA-79	Flour Trough (Factory installation only)	274 /lin. ft.
TA-82	Scrap Chute (6" dia. opening)	350
TA-84	Simple Pass-Thru	921 /lin. ft.
TA-87	Enclosed Rear Splash	130 /lin. ft.
TA-91	Poly Retaining Clips Includes TA-22 (S/S top table)	644 /table

TA-93	Wall Brackets (Includes 2. For 5" & 10 1/2" splash only)	111 /table
TA-96A	Can Opener Provision for Openers with Bolt-on Base (Customer to provide location)	\$309 ea.
TA-96B	Can Opener Surface Mount Provision with 4" S/S Tube for Openers w/o Base (Customer to provide location)	774 ea.
TA-96C	Can Opener Spacer Plate Provision for Use on Tables With Countertop Edge & Can Opener Base (Customer to provide location)	479 ea.
TA-100	Bull Nose All Sides of Worktable	N/C
TA-101	Rear Tray Lock	130 /lin. ft.
TA-106	Mirror Hi-LITE Edge	581 /table
TA-107	Vacuum Breaker Holes on Tables (Includes Backsplash with 2" Return)	531
TA-108	2" Hole with Grommet for Appliance Cord	191 ea.
TA-112	Hubble Outlet	825 ea.
TA-113	Notch Top for Buyout Unit	1192 ea.
TA-366A	Heavy Duty Understructure Top	466 /table
TA-502	Install Advance Tabco Drop-In Hand Sinks or Hot Food Unit In Work Table Top (Hot Food Unit Requires TA-34 Top Cut-Out & TA-27 Control Panel. Does not include wiring. Consult factory)	773 ea.
TA-503	Install Advance Tabco 7-PS-42/7-PS-43 Hand Sinks for Countertops (Includes Cut-Out)	613 ea.
TA-521	Drop-In urn Trough 1'	216 ea.
TA-522	Drop-In urn Trough 2'	430 ea.
TA-523	Drop-In urn Trough 3'	647 ea.
TA-524	Drop-In urn Trough 4'	864 ea.
TA-525	Drop-In urn Trough 5'	892 ea.
TA-526	Drop-In urn Trough 6'	944 ea.
TA-527	Drop-In urn Trough 7'	1000 ea.
TA-528	Drop-In urn Trough 8'	1029 ea.
TA-529	Drop-In urn Trough 9'	1091 ea.
TA-550	Install Customer Supplied Buyout Items (Does not include wiring. Consult factory)	Call for Price
TA-551	Installation of Customer Supplied Hot Food Wells. (Requires TA-34 Top Cut-Out & TA-27 Control Panel. Does not include wiring. Consult factory)	1152 ea.

Email in your specifications to smartfab@advancetabco.com

61

TABLE MODS

Smart Table Modifications

Call For Installation of Buyout Equipment!

BASE MODIFICATIONS



TA-39
Louvered Hinged Doors

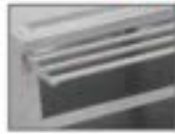

TA-73
Drop-Down Tray Slide

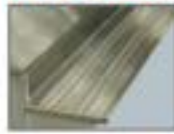

TA-74
Solid Tray Slide



TA-46
Door Lock



TA-116
Adj. Mid-Shelf

TA-4	Removable Access Panel	\$260 /lin. ft.
TA-4A	Louvered Panel	704 /lin. ft.
TA-5	Curb Mounting Provision	294 ea.
TA-15	Provision for Built In Drawer Warmer	564 ea.
TA-23	Legs Welded to Undershelf or Cross-Rails, Shipped Set Up & Crated.	561 /table
TA-23A	Table Legs Welded To Leg Gussets & Undershelf or Cross-Bracing, Shipped Set Up & Crated.	741 /table
TA-24	Shell Crating	414 /table
TA-27	Control Panel (Must add TA-34A)	407 /lin. ft.
TA-36-HINGED	Hinged 30" Stainless Steel Door	647 /door
TA-36-SLIDING	Sliding 30" Stainless Steel Door	647 /door
TA-36B	1/2 Height Stainless Steel Hinge Doors	657 set/2
TA-36C	Hinged door with Trash Flap	906 /ea.
TA-37	Stainless Enclosed Base	934 /lin. ft.
TA-39	24" Louvered Hinged Doors	934 /door
TA-40	Remove Undershelf in Cabinet Base For Slide in Buyout	N/C
TA-42-24	Interior Partition (2.5"x24")	315 ea.
TA-42-30	Interior Partition (2.5"x30")	315 ea.
TA-42-36	Interior Partition (2.5"x36")	315 ea.
TA-43	Filter Panel (3"x30" with Flanged Feet)	637 ea.
TA-44	K.D. Aluminum Pan Rack Slides (6 slides. Table min. lgth. 30")	944
TA-45	K.D. Aluminum Glass Rack Slides (3 slides. Table min. lgth. 3 feet)	862

TA-46	Door Lock	\$451 ea.
TA-48	12"x12" Out-Out in Back Panel/Undershelf for Plumbing	337
TA-54	Removable Kick Plate	216 /lin. ft.
TA-55	Remove Back Panel (on Enclosed Base)	N/C
TA-63	Removable Shelving (in addition to standard shelf & table width)	552 /table.
TA-70	5/5 Tubular Tray Divider (12" sections)	1029 ea.
TA-73	Tubular Tray Slide w/Dropdown (Stationary Tray Slide Available. Factory installation only)	374 /lin. ft.
TA-74	Solid Tray Slide	514 /lin. ft.
TA-92	12" Apron (in front of sink)	237 /lin. ft.
TA-92A	17" Stainless Steel Apron to Cover Sink Bowls and Support Lever Drain Handles	355 /lin. ft.
TA-116	Adjustable Enclosed Base Cabinet Mid Shelf- Add to Price of Enclosed Base Table with Fixed Mid Shelf (M) on Page 50 or 51. Shelves Over 36" in Length Require Multiple Sections With Center Partition. For Partial Shelves Add To Price Of Shelf On Page 68.	1174 ea.
TA-130	Cutlery Dispenser Holder (Undercounter Mounted)	316 /lin. ft.
TA-135	Plate Shelf (Undercounter Mounted)	377 /lin. ft.
TA-205	Connect Cafeteria Items (Per Joint Between 2 Tables. Requires Casters)	752 /set

ELECTRICAL & DATA PORT OUTLETS



TA-62
Duplex Outlet



TA-62A
GFI Duplex Outlet



TA-62D
GFI Doghouse Outlet



TA-62F
Empty Junction Box



TA-112
Hubble Outlet

TA-62A	GFI Duplex Outlet & Cover Plate in a VKS or KSS (1" Deep) Splash. NEMA 5-20R	\$551 ea.
TA-62C	GFI Duplex Outlet & Cover Plate Below Shelf Top. NEMA 5-20R	600 ea.
TA-62D	GFI Duplex Outlet & Cover Plate in a Doghouse. NEMA 5-20R	637 ea.

TA-62E	Upgrade Outlet to a NEMA 6-20R or Equiv.	\$422 ea.
TA-62F	Junction Box (empty) Below Table Top. Includes 1 Gang Size, Stainless Steel Face Plate	290 ea.
TA-112	Hubble Outlet	774 ea.
TA-622	CAT-6 Data Port Connection Provided (unless otherwise specified. Cable Not Included)	570 ea.

Email in your specifications to smartfab@advancetabco.com

MORE TABLE MODS

Smart Table Modifications

OVERSHELF & POT RACK MODIFICATIONS



TA-9A
1" Turn Up



TA-22A
Square Edge



TA-71
Heat Lamp Mounting Provision



TA-100A
Bull Nose

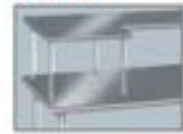

TA-102
24" x 24" Extension

TA-9A	Partial 1" Turn-Up for all Table Mt. Shelves	\$62 /lin. ft.
TA-22A	Square Edge on Overshelf	144
TA-26-10	Welded Wall Shelf Brackets for 10" Wide Shelf	358 /shelf
TA-26-12	Welded Wall Shelf Brackets for 12" Wide Shelf	358 /shelf
TA-26-15	Welded Wall Shelf Brackets for 15" Wide Shelf	358 /shelf
TA-26-18	Welded Wall Shelf Brackets for 18" Wide Shelf	358 /shelf
TA-47	Shelf Mounting Bracket for Existing Table	131 /shelf
TA-49	Wall Shelf 2" Offset	253 /shelf
TA-60	Special Sizing Charge for Shelves (Must Order Larger Unit to be Cut Down to Smaller Size)	N/C
TA-71	Heat Lamp Mounting Provision (Heat Lamp Installed By Others)	228 ea.
TA-71A	Heat Lamp Remote Control Bracket	448 ea.
TA-78	Additional Lin. Ft. Past 12' For Table Mt. Shelf (For ODS, OTS, TS, DS & WS Shelving only)	253 /lin. ft.
TA-77	Check Minder Shelf Provision (Factory install only)	81 /lin. ft.
TA-83	Spice Bins	329 ea.

TA-84A	Knife Rack for Rolled Rim Tables	\$512 ea.
TA-84B	Knife Rack for Poly Top Tables	512 ea.
TA-84C	Knife Rack for Square Edge Tables	512 ea.
TA-86	Stainless Steel Pot Hooks	34 ea.
TA-89	Double Sided Plated Pot Hooks (Package of 4)	91 /pack
TA-89A	Single Sided Plated Pot Hooks (Package of 4)	84 /pack
TA-98	Stainless Steel Flat Bar in lieu of Chain	414 ea.
TA-99	16 Ga. S/S 304 Upgrade for Wall & Over Shelves	35 /lin. ft.
TA-100A	Bull Nose All Sides of Shelf	144
TA-100R	Bull Nose Three Sides of Shelf w/ Rear Turn Up	165
TA-102	24" x 24" Extension for Microwave or Computer Shelf (Add to OTS and ODS Shelves. See page 68)	595 ea.
TA-103	24" Wide PT Shelf (36" Min Length. Mid mt only. See Pg. 73. Add to 18" Wide Shelf)	177 /lin. ft.
TA-104	Additional Length Over 12' (Add to 18" Shelf. (PA & CU Shelving Only. Max. Length is 14' as Single Piece)	383 /lin. ft.

UNDERSHELF MODIFICATIONS

TA-9	1-1/2" Turn-Up for Undershelves	\$59 /lin. ft.
TA-17	Upgrade Undershell to a Marine Edge (Must add TA-23)	644 ea.
TA-48	12"x12" Cut-Out in Back Panel/Undershell for Plumbing	337

TA-94	Upgrade 16 Ga. 304 S/S Undershell	\$75 /lin. ft.
TA-94A	Upgrade 14 Ga. 304 S/S Undershell	95 /lin. ft.
TA-366	Reinforced Understructure For Undershelves	466 /table

SIZE MODIFICATIONS

TA-33	Special Working Height	\$141
TA-33C	Special Working Height For Enclosed Base Tables Up To 39" (For Heights Over 39", Contact Factory).	355 ea.
TA-59	36" Wide Equipment Stand	407 ea.
TA-6	Extra Length for Standard Tables Over 12' (Tables Over 14' Require Field Joint TA-57)	537 /lin. ft.
TA-61	Special Sizing Charge (Larger Unit Cut Down to Smaller Size)	N/C

TA-61A	Special Modification Charge	\$355
TA-65	Enclosed Base Units Over 12' (Open Base Table)	697 /lin. ft.
TA-66	Enclosed Base Units Over 12' (Sliding Door Units)	1015 /lin. ft.
TA-67	Enclosed Base Units Over 12' (Hinged Door Units)	1076 /lin. ft.
TA-105	Modify Enclosed Base Table w/ Drawers to 24" Width	428 /table
TA-110	Modify Enclosed Base Table w/ Drawers to 36" Width	80 /lin. ft.

LEG MODIFICATIONS

TA-16	Galvanized Leg w/ Plastic Bullet Foot (34 1/2" Total Length)	\$85 ea.
TA-16-4	Galvanized Legs w/ Plastic Bullet Feet (34 1/2" Total Length)	341 set/4
TA-16-6	Galvanized Legs w/ Plastic Bullet Feet (34 1/2" Total Length)	510 set/6
TA-19	Flanged Stainless Steel Bullet Foot (34 1/2" Total Length)	81 ea.
TA-19L	Flanged S/S Bullet Foot For Enclosed Base Table	111 ea.
TA-20	Stainless Steel Leg w/ S/S Bullet Foot (34 1/2" Total Length)	99 ea.
TA-20-4	Stainless Steel Legs w/ S/S Bullet Feet (34 1/2" Total Length)	392 set/4

TA-20-6	Stainless Steel Legs w/ S/S Bullet Feet (34 1/2" Total Length)	\$590 set/6
TA-21	Stainless Steel Bullet Foot	39 ea.
TA-68	Relocate rear cross rail to center (for chairs/stools on both sides of table. For Open Base Tables Only)	154 ea.
TA-72	Leg to Wall Brace (Set per table)	435 /table
TA-95	Upgrade 16 Ga. 304 S/S Legs Only	185 /table

TABLE ACCESSORIES

Smart Table Accessories

Faucets Included Meet Federal Lead Free Standards

COUNTERTOP INSTALLED HAND SINKS

- 4" Side Splashes
- K-52 Lead Free Compliant Deck Mounted Faucet
- Undermount Towel Dispenser
- 3-1/2" Basket Drain



7-PS-42 \$3908

Bowl Size: 10" x 14" x 5"
Overall Size: 18-1/4" x 17-5/8"
30 lbs. 2 cu. ft. 20 gauge

- 4" Side Splashes
- Deck Mounted Lead Free Compliant Goose-neck Spout
- Undermount Towel Dispenser
- Knee Operated Valve
- 3-1/2" Basket Drain



7-PS-43 \$4524

Bowl Size: 10" x 14" x 5"
Overall Size: 18-1/4" x 17-5/8"
36 lbs. 2 cu. ft. 20 gauge



7-PS-43 Shown in Table

For Factory Installation Add TA-503 \$613

Can Be Purchased Separately For In-Field Installation

DROP-IN HAND SINKS & WATER STATIONS

For Custom Cut-Out Add TA-34 \$323 For Factory Installation Add TA-502 \$703

IMPROVED!
Stronger Actuator



DI-1-5SP \$2159

6" Tapered Side Splash

Splash on Rear and Both Sides
10" x 14" x 5" Bowl
Overall: 13" x 19"
Cut-out: 12 1/4" x 18 1/4"
16 lbs. 2 cu. ft. 20 gauge



DI-1-10SP \$2319

6" Tapered Side Splash

Splash on Rear and Both Sides
10" x 14" x 10" Bowl
Overall: 13" x 19"
Cut-out: 12 1/4" x 18 1/4"
18 lbs. 2 cu. ft. 20 gauge



DI-1-9 \$1466

Removable Electro-Polished Stainless Steel Grill
1 1/2" IPS Basket Drain
Overall: 12" x 14"
Cut-Out Size: 11 1/4" x 13 1/4"
15 lbs. 3 cu. ft.

Water Stations with Ice Bins

Includes K-54 8-1/4" Filler Faucet With "Push-Back" Acrylic Lever Arm (Excludes D-24-SIBL)

IMPROVED!
Stronger Actuator



Ice Bin Inside Dim.:
8" x 13 1/2" x 10 13/16"
Ice Capacity: 23 lbs.

D-24-WSIBL \$1969

Removable Grate Covers Drip Pan
13" Deep Insulated Ice Bin w/ 5/5 Steel Cover
1" IPS Drain
Outside Dim.: 21" x 18"
Cut-Out Size: 20 5/8" x 15 1/4"
30 lbs. 5 cu. ft.

IMPROVED!
Stronger Actuator



Ice Bin Inside Dim.:
13 1/2" x 18 3/4" x 10 13/16"
Ice Capacity: 50 lbs.

D-24-WSIBL2 \$2355

Removable Grate Covers Drip Pan
13" Deep Insulated Ice Bin w/ 5/5 Steel Cover
1" IPS Drain
Outside Dim.: 18" x 21"
Cut-Out Size: 15 1/4" x 20 5/8"
47 lbs. 5 cu. ft.

IMPROVED!
Stronger Actuator



Includes Sliding Stainless Steel Cover

D-24-SIBL \$2104

K-51 Deck Mounted Faucet
Insulated Ice Bin w/ 5/5 Cover
1" IPS Drain in Ice Bin
Outside Dim.: 21" x 18"
Cut-Out Size: 20 5/8" x 15 1/4"
Factory Installed Only
20 Gauge Galvanized Steel
30 lbs. 5 cu. ft.

Hand Sink Size:
9 1/2" x 11 1/2" x 6"

Ice Bin Inside Dim.:
8" x 13 1/2" x 10 13/16"

Ice Capacity: 23 lbs.

Upgrade to a 12" Filler Faucet
Use K-540MIT, Deduct -\$420 and Add K-54A \$845
(K-540MIT \$5.07 is ordered with K-54A to receive upgrade)



INTEGRAL SINKS

Integral Sinks

WELDED SINKS INTO TABLE TOP

Includes Lead Free Compliant Faucet & K-6 Basket Drain(s)



Flat Top, 1", 1-1/2" & 5 Backsplash Include Deck Mount Faucet

- Single Sink Bowl provided with K-50 Swing Spout Faucet
- Double Sink Bowls provided with K-53 Swing Spout Faucet

10" Backsplash Include Splash Mount Faucet

- Single & Double Sink Bowls provided with K-1 Swing Spout Faucet
- Splash Mount Faucet Available On 5" Backsplash - Add TA-11Z \$62/lin. ft.



Flat Top
w/ K-50
Deck Mount
Faucet Shown



10" Backsplash
w/ K-1
Splash Mount
Faucet Shown

Size		Single Bowl		Double Bowl	
A	B	Model#	Price	Model#	Price
10"	14" x 5"	TA-11Q	\$1595	TA-11Q-2'	\$2914
10"	14" x 10"	TA-11F	1717	TA-11F-2'	3285
14"	16" x 12"	TA-11J	1807	TA-11J-2	3380
16"	20" x 8"	TA-11A**	1795	TA-11A-2**	3340
16"	20" x 12"	TA-11B**	2005	TA-11B-2**	3686
16"	20" x 14"	TA-11V**	2333	TA-11V-2**	3957
16"	24" x 14"	TA-11K**	2341	TA-11K-2**	3966
18"	18" x 14"	TA-11N	2046	TA-11N-2	3692
18"	24" x 14"	TA-11L	2071	TA-11L-2	3722
20"	20" x 8"	TA-11C*	1895	TA-11C-2*	3665
20"	20" x 12"	TA-11D*	2157	TA-11D-2*	3879
20"	20" x 14"	TA-11W*	2259	TA-11W-2*	4144
20"	24" x 14"	TA-11P	2198	TA-11P-2	3949
20"	28" x 12"	TA-11G*	2522	TA-11G-2*	4563
20"	30" x 14"	TA-11S*	2399	TA-11S-2*	4469
24"	24" x 14"	TA-11E*	2518	TA-11E-2*	4248
24"	30" x 14"	TA-11T*	2467	TA-11T-2*	4703
24"	36" x 14"	TA-11R*	2549	TA-11R-2*	4774

* Only Installed In Tables 30" Wide or Wider

** Bowls Are Turned With 16" Front to Back on 24" Wide Tables

† K-50 Swing Spout Faucet (Double Bowl)

FLAT TOP, 1" or 1-1/2" REAR SPLASH

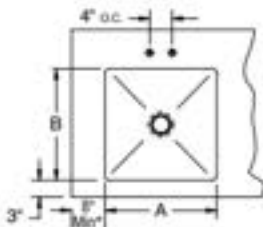

5" REAR SPLASH with 1" RETURN

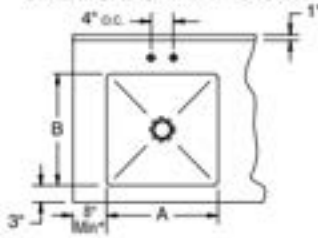

10" REAR SPLASH with 2" RETURN

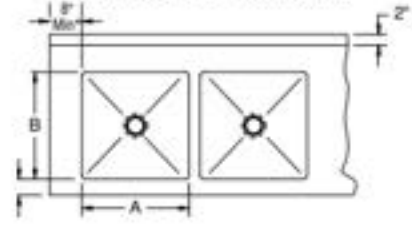

Modifications



TA-56 \$650
5" NSF Partition



TA-92 \$237
Add 12" Apron
In Front Of Sink



TA-11Z \$62/lin. ft.
(Return Only)
Modify 5" Splash To Have 2" Return
For Splash Mounted Faucet

Faucets & Accessories

K-2B	Poly-Vance Sink Cutting Board for 14" x 16" Bowls	\$413 ea.	K-54A	12" Water Filter Faucet	\$845
K-2C	Poly-Vance Sink Cutting Board for 16" x 20" Bowls	413 ea.	K-55	8 1/2" Spout 4" O.C. Deck Mounted Gooseneck Faucet	626
K-2D	Poly-Vance Sink Cutting Board for 18" x 24" Bowls	413 ea.	K-60	4" O.C. Splash Mounted Gooseneck Faucet	812
K-2E	Poly-Vance Sink Cutting Board for 20" x 20" Bowls	413 ea.	K-62	K.H.D. 4" O.C. Deck Mounted Gooseneck Faucet	644
K-2F	Poly-Vance Sink Cutting Board for 24" x 24" Bowls	413 ea.	K-105	14" Splash Mounted 8" O.C. Faucet	704
K-2J	Poly-Vance Sink Cutting Board for 18" x 18" Bowls	413 ea.	K-112	Extra Heavy Duty 12" Splash Mounted Faucets	674
K-4	Lever Drain Bracket	178	K-316-LU	Wrist Handles For Splash Mounted Faucets	167
K-5	Lever Drain	388	K-350	Residential Finish & Packaging	503
K-12	Deck Mounted Soap Dispenser	211	K-452	8" x 9" Control Bracket	373
K-15	Lever Drain With Overflow	688	K-453	14" x 18" Control Bracket	400
K-50	8" Deck Mounted 4" O.C. Swing Spout Faucet	377	K-460	Installation Of Disposal Cone w/ 8" x 9" Control Bracket	1115
K-50OMIT	Omit Swing Spout	-24	K-461	Installation Of Collar w/ 8" x 9" Control Bracket	1115
K-52	3 1/2" Spout Deck Mounted 4" O.C. Gooseneck Faucet	325	K-470	14" Deep Bowls	242
K-52OMIT	Omit Swing Spout Gooseneck Faucet	-24	K-472	Faucet Hole Revision	176
K-53	12" Deck Mounted 4" O.C. Swing Spout Faucet	626	DTA-100	Parinase Basket for 20" x 20" Bowls	905
K-54	8-1/4" Water Filter Faucet	744	DTA-125	Parinase Basket for 16" x 20" Bowls	790

WARNING: Equipment that includes a faucet may expose you to chemicals, including lead, that are known to the State of California to cause cancer or birth defects or other reproductive harm. For more info, visit www.p66warnings.ca.gov

DRAWERS

Integral Drawer Slides



REVOLUTIONARY NEW SHD SERIES DRAWER WITH INTEGRAL DRAWER SLIDES

- Stainless Steel Front & Sides
- Self Closing Drawer with Noise Control
- Drawer "Safety Stop" Tab
- Removable Stainless Steel Insert
- Units Can Be Stacked to Create Multiple Tier Drawers
- Hardware Included
- NSF Approved

Drawers Stack With Ease To Create Tier Drawers! Easily Installs In Field



Features a "Safety Stop" Tab

	Insert Size	Price
SHD-2015	20" x 15" x 5" Overall Dim. 24 5/8" x 17 1/2"	\$1443
SHD-1520	15" x 20" x 5" Overall Dim. 17 1/2" x 24 5/8"	\$1443
SHD-2020	20" x 20" x 5" Overall Dim. 24 5/8" x 22 11/16"	\$1541

NSF

SHD Series Modifications & Accessories

TA-2	Concealed Side Panel For 20" x 15" Drawer (Add Additional Cost to TA-SHD-1, 2, or 3 Price)	\$55 ea.
TA-13	Padlockable Drawer Lock	\$380
TA-14SHD	Drawer Lock For SHD Drawers	\$218
TA-975SHD	Poly Board Storage Brackets For SHD Drawers	\$441
TA-415HD	5/8" Thick Poly Cutting Board For SHD Drawers	\$213 ea.

Optional Concealed Side Panels For 20"x20" Drawers (1 Needed For Each Side)



1 Drawer:
TA-SHD-1
\$224

2 Drawers:
TA-SHD-2 \$282
each side

3 Drawers:
TA-SHD-3
\$339



TA-975HD \$441
Poly Board Storage Bracket
(Installs In Field. Hardware Included)



Rear View of Multiple Stacked Drawers. Seams Exposed

DELUXE SERIES DRAWERS

- Stainless Steel Front
- Ball Bearing Slides
- Removable Insert



Insert Size	All Stainless Steel		All Stainless Steel with Keyed Lock	
	Model #	Price	Model #	Price
20" x 15" x 5"	SS-2015	\$791	SS-2015-DL	\$978
15" x 20" x 5"	SS-1520	791	SS-1520-DL	978
20" x 20" x 5"	SS-2020	856	SS-2020-DL	1045

Deluxe and Budget Drawer Accessories

Padlockable Drawer Lock (Does not include lock. Fits padlocks up to 3/8" Dia. lock shaft)	
TA-13	\$380
Keyed Drawer Lock for SS Series Drawers	
TA-14	196
Drawer Adapter/Non Catalog Tables (specify table width)	
TA-90	91
Replacement Drawer Slides (For Discontinued Models FS & FG Series)	
TA-SL-15	202
Replacement Drawer Slides (SS Series)	
TA-SL-20	218

CONCEALED HAND SINK DRAWER

Take Back Your Countertop Space!

- Easily Installs into Existing Advance Tabco Work Tables/Countertops or Integrates into Custom Fabrication
- Overall Size: 22 5/8" W x 19 7/8" L x 19 1/4" H
- 10" x 14" x 5" Deep Sink Bowl
- Pre-Drilled Holes in Flanges For Easy Mounting
- Integral Drawer Slides For Smooth Operation
- "Safety Stop" Tab
- K-50 Swing Spout Faucet
- 1-1/2" Sink Drain with Strainer Plate
- Drainage Pan with 1-1/2" Drain & Strainer Plate (Drain Pipe & Fittings Included.)

7-PS-47 \$3813

70 lbs. 7 cu. ft. 18 gauge



All Units on this Page Feature
SHD Series Drawers!

DRAWERS

Integral Drawer Slides

MOBILE DRAWER CABINETS

- Stainless Steel Top Features Countertop Edge
- 5" Swivel Plate Casters (2 with Brakes)
- Available with Three or Four Tier Drawers

Model #	Overall Size L x W x H	# Of Drawers	Drawer Size	Price
MDC-2020	25 1/4" x 25 3/4" x 29 1/2"	3	20" x 20" x 5"	\$5947
MDC-4-2020	25 1/4" x 25 3/4" x 29 1/2"	4	20" x 20" x 5"	7242
MDC-2015	25 1/4" x 21 3/4" x 29 1/2"	3	20" x 15" x 5"	5753
MDC-4-2015	25 1/4" x 21 3/4" x 29 1/2"	4	20" x 15" x 5"	7019



FACTORY INSTALLED "SHD SERIES" TIER DRAWERS

New 4 Tier Unit Offers More Storage,
Same Height as 3 Tier Units!

3 or 4 Tiers Available
Factory Installation Only

Model #	# Of Tiers	Inset Size	Price
TA-38	3 Tiers	20" x 20" x 5"	\$5433
TA-384	4 Tiers	20" x 20" x 5"	6567



TA-38 SHOWN

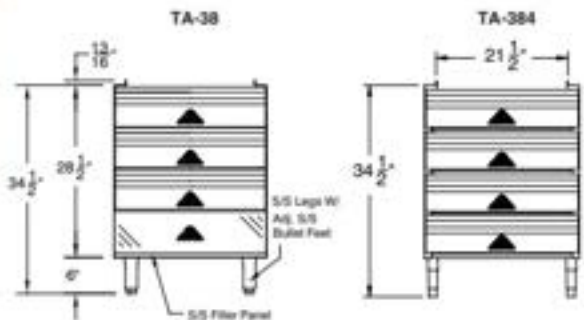

For Tier Drawers on 24" Tables,
Add TA-380 \$213 (Drawers will be 20" x 15" x 5")



ADT-3-2020 SERIES SHOWN
(Table Not Included)



ADD-A-TIER DRAWERS

Fits Under 24", 30" and 36" Wide
Open Base Work Tables!

Features:

- Units Come Fully Assembled!
 - Includes 2 or 3 SHD-2020 Series Drawers Stacked with 2 TA-SHD Series Concealed Side Panels (See Photos).
 - Hangs From Underside of Open Base Table with Included Hardware.
- (See Page 60 for SHD Series Drawer Details)

Includes 2 Concealed Side Panels



2 Drawer Concealed Panel
Model ADT-2-2020 Shown



3 Drawer Concealed Panel
Model ADT-3-2020 Shown



Rear View of Stacked Drawers
Drawer Seams Exposed

Model #	Overall Size L x W x H	# Of Drawers	Drawer Size	Price
ADT-2-2020	23" x 23" x 14"	2	20" x 20" x 5"	\$3621
ADT-3-2020	23" x 23" x 21"	3	20" x 20" x 5"	5254
ADT-3-2015	23" x 18" x 21"	3	20" x 15" x 5"	4965

CASTERS

Casters

All Casters Ship Via UPS

WORK TABLE CASTERS



Standard Casters

Legs Cut To Maintains Standard 35-1/2" Working Height

200 lbs. Load Capacity Per Caster

When Used w/ Stainless Steel Legs

TA-25S-4 \$594/set of 4 (Two with Brakes)

TA-25S-6 \$897/set of 6 (Two with Brakes)

When Used w/ Galvanized Legs

TA-25G-4 \$594/set of 4 (Two with Brakes)

TA-25G-6 \$897/set of 6 (Two with Brakes)

Castors For Special Height Tables (TA-33) and Open Base Tables (T Series)

TA-25 \$594/set of 4 (Two with Brakes)

TA-25A \$897/set of 6 (Two with Brakes)

200 lbs. Load Capacity Per Caster



Single Replacement Casters

Available With Or Without Brake (Legs Not Included)

200 lbs. Load Capacity Per Caster

TA-25R \$114 ea. (No Brake)

TA-25RB \$140 ea. (With Brake)

Optional Standard Caster Upgrades:

TA-25B \$284/set

For brakes on all wheels (Standard Casters) - Add price to the following models: TA-25, TA-25A, TA-25S-4, TA-25S-6, TA-25G-4, TA-25G-6

TA-25C \$50/Per Caster

Upgrade Standard Caster with Heavy Duty Urethane Wheels (Per Caster)

EQUIPMENT STAND CASTERS



Standard Casters

5" Urethane Wheels, Maintains the Standard 24" Working Height

200 lbs. Load Capacity Per Caster

w/ Stainless Steel Legs

TA-25E \$594/set of 4 (Two with Brakes)

w/ Galvanized Legs

TA-25EG \$594/set of 4 (Two with Brakes)

HEAVY DUTY Casters

5" Urethane Wheels

400 lbs. Load Capacity Per Caster

TA-255 \$791 Super Heavy Duty Set of 4 (Two with Brakes)

TA-256 \$1047 Super Heavy Duty Set of 6 (Two with Brakes)



Enclosed Base Table Casters

Easy Bolt-On Style



TA-255P \$934 Set of 4 (Two with Brakes)

TA-255AP \$1360 Set of 6 (Two with Brakes)

300 lbs. Load Capacity Per Caster

For brakes on all wheels (Enclosed Base Casters) - Add price to models: TA-255P or TA-255AP

TA-255PB \$448

Optional Equipment Stand Caster Upgrade:

TA-255B \$387 For brakes on all wheels (Equipment Casters) - Add price to any of the following models: TA-255, TA-256, TA-25EB, TA-25EG

MID-SHELF & UNDERSHELVES



Shelf Capacity 20 lbs./sq. ft.



Stainless Steel

Galvanized

Length	Stainless Steel			Galvanized								
	24" Wide	Price	30" Wide	Price	36" Wide	Price						
2'	US-24-24	\$473	US-30-24	\$535	NOT AVAILABLE	UG-24-24	\$270	UG-30-24	\$319	NOT AVAILABLE		
30"	US-24-30	535	US-30-30	590	US-36-30	\$677	UG-24-30	319	UG-30-30	327	UG-36-30	\$334
3'	US-24-36	557	US-30-36	677	US-36-36	814	UG-24-36	339	UG-30-36	334	UG-36-36	343
4'	US-24-48	628	US-30-48	763	US-36-48	869	UG-24-48	347	UG-30-48	356	UG-36-48	359
5'	US-24-60	727	US-30-60	827	US-36-60	979	UG-24-60	356	UG-30-60	370	UG-36-60	388
6'	US-24-72	820	US-30-72	941	US-36-72	1154	UG-24-72	359	UG-30-72	388	UG-36-72	397
7'	US-24-84	932	US-30-84	1010	US-36-84	1221	UG-24-84	370	UG-30-84	397	UG-36-84	413
8'	US-24-96	1010	US-30-96	1151	US-36-96	1329	UG-24-96	388	UG-30-96	404	UG-36-96	448
9'	US-24-108	1051	US-30-108	1318	US-36-108	1585	UG-24-108	404	UG-30-108	463	UG-36-108	481
10'	US-24-120	1107	US-30-120	1373	US-36-120	1641	UG-24-120	438	UG-30-120	494	UG-36-120	510
11'	US-24-132	1376	US-30-132	1621	US-36-132	1810	UG-24-132	486	UG-30-132	532	UG-36-132	550
12'	US-24-144	1417	US-30-144	1674	US-36-144	1910	UG-24-144	546	UG-30-144	593	UG-36-144	608

TA-94 \$75 lin. ft. 16 ga. S/S 304 Series Upgrade for any shelf

TA-9 \$59 lin. ft. 1-1/2" Turn-Up for Undershelves

Sleek Shields™ FOOD SHIELDS

Food Shields

MULTI-USE FOOD SHIELDS

Protected By: U.S. Patent No. 11,129,484



Quickly Converts From Cafeteria Style To Self-Serve Style

With Stainless Steel Shelf

18" Standard Shelf Height (Top of Table to Top of Shelf). 24" Wide Shelving Also Available



DSG-12S-48 Glass Positioned For Self-Serve Style

DSG-12S-48 Glass Positioned For Cafeteria Style

- Bottom front glass locks in place at 3 fixed positions
- Entire glass front rotates for easy cleaning
- Stainless Steel 1" diameter Posts.
- Includes Two 18" Wide Glass Side Panels
- 1/4" Thick Heat-Tempered Glass Side Panels
- 3/8" Thick Heat-Tempered Glass Fronts
- Stainless Steel Top Shelf (DSG "S" Series)
- 3/8" Glass Top Shelf (DSG "G" Series)

*Requires a Single Pair of Center Legs (Factory Print Included)
 **Requires Two Pair of Center Legs (Factory Print Included)

12" WIDE	Price	Approx. Wt.	15" WIDE	Price	Approx. Wt.	18" WIDE	Price	Approx. Wt.	Approx. Cubes
DSG-12S-36	\$6403	131 lbs.	DSG-15S-36	\$7180	133 lbs.	DSG-18S-36	\$7487	136 lbs.	14
DSG-12S-48	6624	160 lbs.	DSG-15S-48	7341	169 lbs.	DSG-18S-48	7648	173 lbs.	18
DSG-12S-60	7535	191 lbs.	DSG-15S-60	7888	196 lbs.	DSG-18S-60	8194	199 lbs.	22
DSG-12S-72	7833	237 lbs.	DSG-15S-72	8287	245 lbs.	DSG-18S-72	8787	250 lbs.	26
DSG-12S-84 [†]	8105	276 lbs.	DSG-15S-84 [†]	8663	279 lbs.	DSG-18S-84 [†]	8972	286 lbs.	30
DSG-12S-96 [†]	8804	312 lbs.	DSG-15S-96 [†]	9263	314 lbs.	DSG-18S-96 [†]	9568	323 lbs.	34
DSG-12S-108 [†]	9057	346 lbs.	DSG-15S-108 [†]	9754	353 lbs.	DSG-18S-108 [†]	10061	359 lbs.	38
DSG-12S-120 [†]	9321	382 lbs.	DSG-15S-120 [†]	10052	389 lbs.	DSG-18S-120 [†]	10339	397 lbs.	42
DSG-12S-132 [†]	9552	420 lbs.	DSG-15S-132 [†]	10277	428 lbs.	DSG-18S-132 [†]	10585	437 lbs.	46
DSG-12S-144 ^{††}	9998	455 lbs.	DSG-15S-144 ^{††}	10474	465 lbs.	DSG-18S-144 ^{††}	10782	473 lbs.	50



Bottom Glass Flips All The Way Up To Become A Self-Serve Unit



Bottom Glass Can be Used As a Shelf



Easy To Use Mechanism For Changing Front Glass Positions



Entire Glass Shield Rotates For Easy Cleaning

With 3/8" Glass Top

18" Standard Shelf Height (Top of Table to Top of Glass Shelf)



DSG-12G-72 Glass Positioned For Self-Serve Style

DSG-12G-72 Glass Positioned For Cafeteria Style

12" WIDE	Price	Approx. Wt.	15" WIDE	Price	Approx. Wt.	18" WIDE	Price	Approx. Wt.	Approx. Cubes
DSG-12G-36	\$7635	139 lbs.	DSG-15G-36	\$8472	143 lbs.	DSG-18G-36	\$9086	147 lbs.	18
DSG-12G-48	7853	179 lbs.	DSG-15G-48	8631	182 lbs.	DSG-18G-48	9248	187 lbs.	23
DSG-12G-60	8764	228 lbs.	DSG-15G-60	9178	235 lbs.	DSG-18G-60	9778	242 lbs.	29
DSG-12G-72	9066	279 lbs.	DSG-15G-72	9580	266 lbs.	DSG-18G-72	10197	275 lbs.	34
DSG-12G-84 [†]	9342	298 lbs.	DSG-15G-84 [†]	9955	305 lbs.	DSG-18G-84 [†]	10568	316 lbs.	39
DSG-12G-96 [†]	10033	330 lbs.	DSG-15G-96 [†]	10552	346 lbs.	DSG-18G-96 [†]	11169	357 lbs.	44
DSG-12G-108 [†]	10287	373 lbs.	DSG-15G-108 [†]	11045	383 lbs.	DSG-18G-108 [†]	11660	397 lbs.	49
DSG-12G-120 [†]	10551	412 lbs.	DSG-15G-120 [†]	11322	424 lbs.	DSG-18G-120 [†]	11938	439 lbs.	55
DSG-12G-132 [†]	10782	453 lbs.	DSG-15G-132 [†]	11570	467 lbs.	DSG-18G-132 [†]	12185	483 lbs.	60
DSG-12G-144 ^{††}	11228	495 lbs.	DSG-15G-144 ^{††}	11765	511 lbs.	DSG-18G-144 ^{††}	12416	528 lbs.	65

FOOD SHIELDS

Adjustable Food Shields

Sleek Shields™

Protected By: Patent No. US 9,010,883 B2

With Stainless Steel Shelf

18" Standard Shelf Height (Top of Table to Top of Shelf) • 24" Wide Shelving Also Available

*Requires a Single Pair of Center Legs (Factory Print Included)
 **Requires Two Pair of Center Legs (Factory Print Included)
 †3/8" Thick Heat-Tempered Glass Required For Front Glass

Exclusive Features Of NSG/NSD/NSGC Sleek Shields:

- Front glass locks in place at 15" intervals
- Stainless Steel 1" diameter Posts
- Includes Two 1/4" Heat-Tempered Side Glass
- 1/4" or 3/8" Thick Heat-Tempered Glass Front Panels (See Chart For "*" Symbol)
- Shelves have two rolled edges on front & rear and square edges on left & right sides

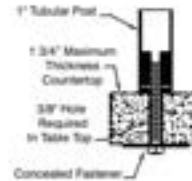

Includes Standard Concealed Mounting Hardware
 (Access To Underside Of Counter Required)

Sleek Shields™ w/ Stainless Steel or Glass Shelf Can Be Added To All Hot/Cold Food Tables On Pages 123-131
 See Sleek Shield Models For Food Tables On Page 136



SELF SERVE STYLE

12" WIDE	Price	Approx. Wt.	15" WIDE	Price	Approx. Wt.	18" WIDE	Price	Approx. Wt.	Approx. Cubes
NSG-12-36	\$4270	120 lbs.	NSG-15-36	\$4662	122 lbs.	NSG-18-36	\$5788	124 lbs.	18
NSG-12-48	4390	152 lbs.	NSG-15-48	4862	155 lbs.	NSG-18-48	5803	150 lbs.	23
NSG-12-60*	5356	191 lbs.	NSG-15-60*	5408	194 lbs.	NSG-18-60*	6392	198 lbs.	29
NSG-12-72*	5542	221 lbs.	NSG-15-72*	5808	228 lbs.	NSG-18-72*	6794	230 lbs.	34
NSG-12-84†	5812	254 lbs.	NSG-15-84†	6182	260 lbs.	NSG-18-84†	7167	265 lbs.	39
NSG-12-96†	6508	288 lbs.	NSG-15-96†	6779	293 lbs.	NSG-18-96†	7763	299 lbs.	44
NSG-12-108**	6763	314 lbs.	NSG-15-108**	7269	321 lbs.	NSG-18-108**	8253	327 lbs.	49
NSG-12-120**	7025	363 lbs.	NSG-15-120**	7548	370 lbs.	NSG-18-120**	8532	376 lbs.	55
NSG-12-132**	7257	398 lbs.	NSG-15-132**	7797	406 lbs.	NSG-18-132**	8782	413 lbs.	60
NSG-12-144††	7702	422 lbs.	NSG-15-144††	7996	430 lbs.	NSG-18-144††	8980	439 lbs.	65

SELF SERVE STYLE - DOUBLE TIER

12" WIDE	Price	Approx. Wt.	15" WIDE	Price	Approx. Wt.	18" WIDE	Price	Approx. Wt.	Approx. Cubes
NSDG-12-36	\$6743	155 lbs.	NSDG-15-36	\$7940	160 lbs.	NSDG-18-36	\$8026	166 lbs.	26
NSDG-12-48	7832	194 lbs.	NSDG-15-48	7238	199 lbs.	NSDG-18-48	8220	206 lbs.	34
NSDG-12-60*	7944	243 lbs.	NSDG-15-60*	7785	250 lbs.	NSDG-18-60*	8771	258 lbs.	41
NSDG-12-72*	8245	277 lbs.	NSDG-15-72*	8185	290 lbs.	NSDG-18-72*	9174	308 lbs.	49
NSDG-12-84†	8521	324 lbs.	NSDG-15-84†	8560	330 lbs.	NSDG-18-84†	9544	344 lbs.	56
NSDG-12-96†	9216	353 lbs.	NSDG-15-96†	9158	365 lbs.	NSDG-18-96†	10144	376 lbs.	64
NSDG-12-108**	9468	389 lbs.	NSDG-15-108**	9648	405 lbs.	NSDG-18-108**	10628	411 lbs.	71
NSDG-12-120**	9733	443 lbs.	NSDG-15-120**	9929	445 lbs.	NSDG-18-120**	10912	457 lbs.	79
NSDG-12-132**	9963	483 lbs.	NSDG-15-132**	10174	496 lbs.	NSDG-18-132**	11361	503 lbs.	86
NSDG-12-144††	10090	513 lbs.	NSDG-15-144††	10372	548 lbs.	NSDG-18-144††	11490	548 lbs.	94



10-1/2" Standard Glass Opening (Maximum 13")
 From Table To Bottom Of Glass.

CAFETERIA STYLE

12" WIDE	Price	Approx. Wt.	15" WIDE	Price	Approx. Wt.	18" WIDE	Price	Approx. Wt.	Approx. Wt.
NSGC-12-36	\$4763	125 lbs.	NSGC-15-36	\$5541	129 lbs.	NSGC-18-36	\$5848	130 lbs.	18
NSGC-12-48	4985	160 lbs.	NSGC-15-48	5701	163 lbs.	NSGC-18-48	6008	167 lbs.	23
NSGC-12-60*	5894	185 lbs.	NSGC-15-60*	6249	190 lbs.	NSGC-18-60*	6556	193 lbs.	29
NSGC-12-72*	6193	231 lbs.	NSGC-15-72*	6650	239 lbs.	NSGC-18-72*	7147	244 lbs.	34
NSGC-12-84†	6467	270 lbs.	NSGC-15-84†	7022	274 lbs.	NSGC-18-84†	7332	281 lbs.	39
NSGC-12-96†	7164	306 lbs.	NSGC-15-96†	7624	308 lbs.	NSGC-18-96†	7927	317 lbs.	44
NSGC-12-108**	7418	340 lbs.	NSGC-15-108**	8113	347 lbs.	NSGC-18-108**	8419	353 lbs.	49
NSGC-12-120**	7680	376 lbs.	NSGC-15-120**	8412	383 lbs.	NSGC-18-120**	8698	391 lbs.	55
NSGC-12-132**	7913	414 lbs.	NSGC-15-132**	8638	422 lbs.	NSGC-18-132**	8946	431 lbs.	60
NSGC-12-144††	8357	450 lbs.	NSGC-15-144††	8835	574 lbs.	NSGC-18-144††	9143	467 lbs.	65



1-1/2" Standard Glass Opening (Maximum 1-1/2")
 From Table To Bottom Of Glass.

CUSTOM UNITS & SIZES AVAILABLE ON ALL FOOD SHIELDS

Food Shield Prices May Change Due To Customer Specifications & Design

Sleek Shields™

Protected By: Patent No. US 9,010,883 B2

FOOD SHIELDS

Adjustable Food Shields

With Glass Top ^{NSF}

3/8" Thick Heat-Tempered Glass Top

*Requires a Single Pair of Center Legs (Factory Print Included)
 **Requires Two Pair of Center Legs (Factory Print Included)
 †3/8" Thick Heat-Tempered Glass Required For Front Glass

Exclusive Features Of GSG/GSGC/NSGD Sleek Shields:

- Front glass locks in place at 15" intervals
- Stainless Steel 1" diameter Posts
- Includes Two 1/4" Heat-Tempered Side Glass
- 1/4" or 3/8" Thick Heat-Tempered Glass Front Panels (See Chart For "*" Symbol)
- Glass Top Features 3/8" Heat-Tempered Glass Top

SELF SERVE STYLE

12" WIDE	Price	Approx. Wt.	15" WIDE	Price	Approx. Wt.	18" WIDE	Price	Approx. Wt.	Approx. Cubes
GSG-12-36	\$4798	127 lbs.	GSG-15-36	\$5480	146 lbs.	GSG-18-36	\$6097	133 lbs.	18
GSG-12-48	5004	162 lbs.	GSG-15-48	5680	187 lbs.	GSG-18-48	6295	173 lbs.	23
GSG-12-60*	5930	202 lbs.	GSG-15-60*	6326	234 lbs.	GSG-18-60*	6842	216 lbs.	29
GSG-12-72†	6113	238 lbs.	GSG-15-72†	6629	274 lbs.	GSG-18-72†	7242	253 lbs.	34
GSG-12-84†	6387	274 lbs.	GSG-15-84†	7004	316 lbs.	GSG-18-84†	7619	292 lbs.	39
GSG-12-96†	7085	309 lbs.	GSG-15-96†	7559	357 lbs.	GSG-18-96†	8216	330 lbs.	44
GSG-12-108**	7333	338 lbs.	GSG-15-108**	8092	392 lbs.	GSG-18-108**	8685	362 lbs.	49
GSG-12-120**	7598	381 lbs.	GSG-15-120**	8369	451 lbs.	GSG-18-120**	8983	417 lbs.	55
GSG-12-132**	7831	427 lbs.	GSG-15-132**	8644	495 lbs.	GSG-18-132**	9233	457 lbs.	60
GSG-12-144††	8276	455 lbs.	GSG-15-144††	8815	529 lbs.	GSG-18-144††	9431	489 lbs.	65



10-1/2" Standard Glass Opening (Maximum 13")
 From Table To Bottom Of Glass.
 Max. Load For Top Glass Is 100 Lbs. Even Dist. Wt.

CAFETERIA STYLE

12" WIDE	Price	Approx. Wt.	15" WIDE	Price	Approx. Wt.	18" WIDE	Price	Approx. Wt.	Approx. Cubes
GSGC-12-36	\$5338	133 lbs.	GSGC-15-36	\$6178	137 lbs.	GSGC-18-36	\$6793	141 lbs.	18
GSGC-12-48	5555	173 lbs.	GSGC-15-48	6336	176 lbs.	GSGC-18-48	6952	182 lbs.	23
GSGC-12-60*	6467	222 lbs.	GSGC-15-60*	6883	229 lbs.	GSGC-18-60*	7482	236 lbs.	29
GSGC-12-72†	6772	274 lbs.	GSGC-15-72†	7285	280 lbs.	GSGC-18-72†	7902	289 lbs.	34
GSGC-12-84†	7046	292 lbs.	GSGC-15-84†	7659	309 lbs.	GSGC-18-84†	8273	311 lbs.	39
GSGC-12-96†	7740	330 lbs.	GSGC-15-96†	8256	340 lbs.	GSGC-18-96†	8873	351 lbs.	44
GSGC-12-108**	7994	367 lbs.	GSGC-15-108**	8748	377 lbs.	GSGC-18-108**	9362	391 lbs.	49
GSGC-12-120**	8253	406 lbs.	GSGC-15-120**	9027	419 lbs.	GSGC-18-120**	9642	434 lbs.	55
GSGC-12-132**	8487	447 lbs.	GSGC-15-132**	9274	461 lbs.	GSGC-18-132**	9898	477 lbs.	60
GSGC-12-144††	8932	489 lbs.	GSGC-15-144††	9470	505 lbs.	GSGC-18-144††	10121	522 lbs.	65

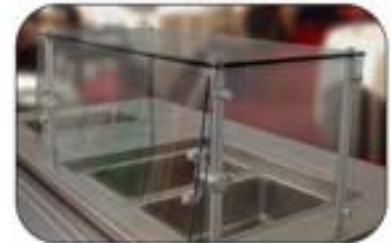

1-1/2" Standard Glass Opening (Maximum 1-1/2")
 From Table To Bottom Of Glass.
 Max. Load For Top Glass Is 100 Lbs. Even Dist. Wt.

SELF SERVE STYLE - DOUBLE SIDED

w/ Stainless Steel Shelf			w/ Glass Top			Approx. Cubes
Model #	Price	Approx. Wt.	Model #	Price	Approx. Wt.	
NSGD-40-36	\$7827	339 lbs.	GSGD-40-36	\$8001	368 lbs.	32
NSGD-40-48	8037	391 lbs.	GSGD-40-48	8213	437 lbs.	42
NSGD-40-60*	8962	451 lbs.	GSGD-40-60*	9137	509 lbs.	51
NSGD-40-72†	9143	510 lbs.	GSGD-40-72†	9379	592 lbs.	61
NSGD-40-84†	9417	604 lbs.	GSGD-40-84†	9593	660 lbs.	70
NSGD-40-96†	10113	667 lbs.	GSGD-40-96†	10289	729 lbs.	79
NSGD-40-108**	10365	725 lbs.	GSGD-40-108**	10937	798 lbs.	89
NSGD-40-120**	10626	782 lbs.	GSGD-40-120**	11331	868 lbs.	98
NSGD-40-132**	10860	840 lbs.	GSGD-40-132**	11561	932 lbs.	107
NSGD-40-144††	11308	909 lbs.	GSGD-40-144††	11817	1001 lbs.	117



GSGD Series Shown
 10-1/2" Standard Glass Opening (Maximum 13")
 From Table To Bottom Of Glass.
 Max. Load For Top Glass Is 100 Lbs. Even Dist. Wt.

Sleek Shields™ w/ Stainless Steel or Glass Shelf Can Be Added To Hot/Cold Food Tables
 With 2, 3 or 4 Wells, Listed On Pages 127 - 135
 See Sleek Shield Models For Food Tables On Page 136



FOOD SHIELDS

Adjustable & Fixed Front Food Shields



For Accessories & Modifications Available - See Page 73

Sleek Shields™ SELF SERVE FOOD SHIELD

14 3/4" Standard Front Glass

Glass Clearance is 16" From Table to Bottom of Glass

Single Front Glass				Dual Front Glass (Includes Center Post)			
Model #	Price	Approx. Wt.	Approx. Cubes	Model #	Price	Approx. Wt.	Approx. Cubes
GS-36	\$5337	136	20	GS-84	\$6933	280	40
GS-48	\$5509	171	26	GS-96	\$190	317	44
GS-60	\$678	266	31	GS-120	\$577	308	48
GS-66	\$904	238	34	GS-132	\$018	306	52
GS-72	\$6713	243	37	GS-144	\$275	434	56



FEATURING
CHAMBER LOCK™
ROTATION SYSTEM
Protected By Patent No. US
9,010,883 B2

- 3/8" Thick Heat-Tempered Glass Front
- 2 - 21 7/8" Wide x 22" High, 1/4" Thick Heat-Tempered Side Glass
- 1" Stainless Steel Tubing Posts



FIXED FRONT GLASS TOP FOOD SHIELDS

Includes Front & Side Glass - 15" Wide Glass Top Also Available

- 3/8" Thick Heat-Tempered Top Glass
- 1/4" Thick Heat-Tempered Front Glass*
- Two 1/4" Thick Heat-Tempered Glass Side Panels
- 1" Stainless Steel Round Tubing
- Includes Standard Concealed Mounting Hardware (Access To Underside Of Counter Required)



STFS-12-36 Series shown



STFC-12-36 Series shown

Self-Serve Style 8" Standard Front Glass Height						Cafeteria Style 18" Standard Front Glass Height							
L	12" WIDE	Price	Wt.	18" WIDE	Price	Wt.	12" WIDE	Price	Wt.	18" WIDE	Price	Wt.	Cubes
36"	STFS-12-36	\$3331	127 lbs.	STFS-18-36	\$4630	133 lbs.	STFC-12-36	\$3871	133 lbs.	STFC-18-36	\$5326	141 lbs.	18
48"	STFS-12-48	\$539	162 lbs.	STFS-18-48	\$829	173 lbs.	STFC-12-48	\$409	173 lbs.	STFC-18-48	\$486	182 lbs.	23
60"	STFS-12-60*	\$464	202 lbs.	STFS-18-60*	\$376	216 lbs.	STFC-12-60*	\$501	222 lbs.	STFC-18-60*	\$616	236 lbs.	29
72"	STFS-12-72*	\$646	238 lbs.	STFS-18-72*	\$777	253 lbs.	STFC-12-72*	\$305	274 lbs.	STFC-18-72*	\$435	269 lbs.	34
84"	STFS-12-84†	\$920	274 lbs.	STFS-18-84†	\$151	292 lbs.	STFC-12-84†	\$579	292 lbs.	STFC-18-84†	\$807	311 lbs.	39
96"	STFS-12-96†	\$619	309 lbs.	STFS-18-96†	\$749	330 lbs.	STFC-12-96†	\$272	330 lbs.	STFC-18-96†	\$745	351 lbs.	44
108"	STFS-12-108††	\$866	338 lbs.	STFS-18-108††	\$718	362 lbs.	STFC-12-108††	\$526	367 lbs.	STFC-18-108††	\$796	391 lbs.	49
120"	STFS-12-120††	\$131	391 lbs.	STFS-18-120††	\$7516	417 lbs.	STFC-12-120††	\$787	406 lbs.	STFC-18-120††	\$175	434 lbs.	55
132"	STFS-12-132††	\$365	427 lbs.	STFS-18-132††	\$768	457 lbs.	STFC-12-132††	\$7019	447 lbs.	STFC-18-132††	\$421	477 lbs.	60
144"	STFS-12-144††	\$809	455 lbs.	STFS-18-144††	\$7965	489 lbs.	STFC-12-144††	\$7465	489 lbs.	STFC-18-144††	\$655	522 lbs.	65

*3/8" Thick Heat-Tempered Glass Required For Front † Requires a single pair of center legs †† Requires two pair of center legs

45° ANGLED FIXED FRONT FOOD SHIELDS

Self-Serve Style
w/ Angled Top & Side Glass

Model #	Price	Approx. Wt.	Approx. Cubes
AFS-36	\$4727	130 lbs.	6
AFS-48	\$380	164 lbs.	8
AFS-60*	\$903	207 lbs.	10



Shown With Black Powder Coating

- 1/4" Thick Heat-Tempered Front Glass
- 1/4" Thick Side Glass
- 1" Stainless Steel Tubing with End Caps
- Includes Standard Concealed Mounting Hardware (Access To Underside Of Counter Required)

Cafeteria Style
w/ Angled Top, Front & Side Glass

Model #	Price	Approx. Wt.	Approx. Cubes
AFC-36	\$5594	143 lbs.	6
AFC-48	\$635	178 lbs.	8
AFC-60*	\$402	235 lbs.	10



FIXED FRONT VERTICAL FOOD SHIELDS



For Enclosed Base Table Options See Pages 80-81

- 24" Standard Front Glass height
- 1/4" Thick Heat-Tempered Glass
- Two 18" Wide Glass Side Panels
- 1" Stainless Steel Tubing with End Caps (1 5/8" Tubing Also Available)
- Includes Standard Concealed Mounting Hardware (Access To Underside Of Counter Required)

- NSF Requires 60" Minimum Height Above Finished Floor
- NSF Requires 6" Maximum Height From Top of Table to Bottom of Glass

Custom Food Shield Sizes Available
Call Our Smart Fabrication™ Department At
800-645-3166

Model #	Price	Approx. Wt.	Approx. Cubes
SGCC-36	\$6368	139 lbs.	9
SGCC-48	\$7033	194 lbs.	11
SGCC-60*	\$7927	219 lbs.	13
SGCC-72	\$10038	240 lbs.	15
SGCC-84	\$9955	271 lbs.	17
SGCC-96	\$10474	311 lbs.	19
SGCC-108*	\$11320	357 lbs.	22
SGCC-120*	\$12404	412 lbs.	25
SGCC-132	\$13186	451 lbs.	26
SGCC-144	\$14130	518 lbs.	27

*3/8" Thick Heat-Tempered Glass Required For Front



FOOD SHIELDS

Modifications & Accessories

SLEEK SHIELDS™ ACCESSORIES & MODIFICATIONS

LED Display Lighting

Factory Installed

- Aluminum Plail with Shatter-Proof Optics
- Standard Natural Aluminum Finish. Available in White or Black
- Includes Class 2 Low Voltage Power Supply: 120V-277V
- High Impact Resistant Mounting Clips



FACTORY INSTALLED ONLY
Includes Installation Charge

L	S/S Shelf Mounted		Glass Top Mounted	
	Model #	Price	Model #	Price
1'	LED-S-12	\$548	LED-G-12	\$803
2'	LED-S-24	660	LED-G-24	944
3'	LED-S-36	761	LED-G-36	1045
4'	LED-S-48	849	LED-G-48	1139
5'	LED-S-60	944	LED-G-60	1202
6'	LED-S-72	1076	LED-G-72	1331

Shelves Require 6" Clearance
On Both Sides
To Fit Above Led Lighting.
PRINT REQUIRED
FOR PROPER LED LOCATION

Heat Lamp Mounting Provisions

Customers To Supply Heat Lamp

All Food Shields With Glass Tops Require
Factory Installation Only



FACTORY INSTALLED
TA-717 **\$279** /lin. ft.
MINIMUM OF 3 FEET REQUIRED.
MUST ORDER SAME LENGTH AS
FOOD SHIELD.

- Welded Tubular Stainless Steel Posts
- Chase-Way for Concealing Wiring
- Pre-Wiring Available
- Print Required For Proper Installation

INSTALLED BY OTHERS

(Provision for mounting to Stainless Steel Shelves only)

TA-71 **\$228** ea.

Revolutionary Sleek Shield™ Horizontal Swivel Bracket

- Bracket Connects Multiple Sleek Shields™ And Swivels Freely for Custom Line Up
- Easily Adjusts In Field Without Tools
- Factory Installed Only



SG-5 **\$1762**
Per Section



SG-1

SURFACE MOUNTING BRACKET

(For 1" Posts)

SG-1 **\$164** ea.

REDUCE LENGTH OR WIDTH OF SHELF
Start With Next Largest Size Then Add To Model Number
TA-60 N/C

CANTILEVER SUPPORT BRACKET UPGRADE

(Omits Front or Rear Support Leg To Equipment in Counter)

SG-C **\$609** per leg

SPECIAL HEIGHT FOR FOOD SHIELDS

Please Specify Height
TA-33F **\$70**



SG-PC Shown

CUSTOM COLORS

SG-AN Call For Pricing

Color Anodizing For Sleek Shields™ (For Aluminum Components)

SG-PC Call For Pricing

Powder Coating For Sleek Shields™ (For Stainless Steel Components)

PORTABLE FOOD SHIELDS

- 15" Front Panel
- 1/4" Thick Thermoplastic Polymer Sneeze Guard
- 1" Stainless Steel Posts
- 1-1/2" Wide x 14-1/2" Front to Back Black Support Base
- Shipped K.D.

Length	Model #	Price	Approx. Wt.	Approx. Cubes
24"	PFS-24B	\$2530	11 lbs.	5
36"	PFS-36B	2776	12 lbs.	6
48"	PFS-48B	3214	15 lbs.	18
60"	PFS-60B	3615	18 lbs.	8
72"	PFS-72B	3945	21 lbs.	9



PFS-36B Shown with Optional Side Panels



OPTIONAL 18" WIDE SIDE PANELS

18" x 20" x 1/4" Acrylic Side Panels
Factory Installed Only

PFS-SP **\$1148** /set of 2

Approx. 5 lbs.

SHELVING

Stainless Steel Shelving

TABLE MOUNTED ALL STAINLESS STEEL SHELVING



Shelves Mount to Underside of Table with Single Expansion Bolt to Maximize Space



SINGLE DECK SHELVING

Ft.	12" WIDE	Price	15" WIDE ¹	Price	Approx. Wt.	Approx. Cubes
3'	OTS-12-36	\$1057	OTS-15-36	\$1265	24 lbs.	2
4'	OTS-12-48	1112	OTS-15-48	1372	25 lbs.	3
5'	OTS-12-60	1206	OTS-15-60	1548	31 lbs.	3
6'	OTS-12-72	1284	OTS-15-72	1712	37 lbs.	4
7'	OTS-12-84	1372	OTS-15-84	1791	43 lbs.	5
8'	OTS-12-96*	1657	OTS-15-96*	1929	50 lbs.	5
9'	OTS-12-108*	1760	OTS-15-108*	2297	59 lbs.	6
10'	OTS-12-120*	1807	OTS-15-120*	2353	68 lbs.	7
11'	OTS-12-132*	1901	OTS-15-132*	2638	82 lbs.	7
12'	OTS-12-144*	1958	OTS-15-144*	2697	88 lbs.	8

- SHELVES 8" OR LONGER INCLUDE CENTER LEG SUPPORT

Post Height can be customized! Use TA-33A \$70

DOUBLE DECK SHELVING

12" WIDE	Price	15" WIDE ¹	Price	Approx. Wt.	Approx. Cubes
ODS-12-36	\$2105	ODS-15-36	\$2277	24 lbs.	4
ODS-12-48	2165	ODS-15-48	2452	29 lbs.	5
ODS-12-60	2308	ODS-15-60	2751	35 lbs.	6
ODS-12-72	2461	ODS-15-72	3017	40 lbs.	7
ODS-12-84	2636	ODS-15-84	3273	46 lbs.	8
ODS-12-96*	3143	ODS-15-96*	3661	55 lbs.	10
ODS-12-108*	3385	ODS-15-108*	3983	60 lbs.	11
ODS-12-120*	3443	ODS-15-120*	4144	66 lbs.	12
ODS-12-132*	3676	ODS-15-132*	4369	72 lbs.	13
ODS-12-144*	3733	ODS-15-144*	4563	78 lbs.	14

*8" or longer includes center leg support.

For 1" Rear Turn Up, add "R" after model # (Example: OTS-12-60R) • 15" Wide Shelving has 1-5/8" Tubing

For 10" Wide Shelving - Use 12" Models & Price. Replace "12" with "10" (Example: ODS-10-36)

TABLE MOUNTED FULLY ADJUSTABLE SHELVING WITH 14" OR 30" CHROME POSTS

SINGLE DECK SHELVING

Ft.	12" WIDE	Price	Approx. Wt.	Approx. Cubes
3'	TS-12-36	\$990	13 lbs.	2
4'	TS-12-48	1051	15 lbs.	3
5'	TS-12-60	1123	17 lbs.	3
6'	TS-12-72	1200	20 lbs.	4
7'	TS-12-84	1282	23 lbs.	5
8'	TS-12-96*	1563	28 lbs.	5
9'	TS-12-108*	1662	30 lbs.	6
10'	TS-12-120*	1717	33 lbs.	7
11'	TS-12-132*	1818	36 lbs.	7
12'	TS-12-144*	1878	39 lbs.	8

DOUBLE DECK SHELVING

Ft.	12" WIDE	Price	Approx. Wt.	Approx. Cubes
3'	DS-12-36	\$1953	24 lbs.	4
4'	DS-12-48	2012	29 lbs.	5
5'	DS-12-60	2166	35 lbs.	6
6'	DS-12-72	2319	40 lbs.	7
7'	DS-12-84	2474	46 lbs.	8
8'	DS-12-96*	3000	55 lbs.	10
9'	DS-12-108*	3253	60 lbs.	11
10'	DS-12-120*	3314	66 lbs.	12
11'	DS-12-132*	3562	72 lbs.	13
12'	DS-12-144*	3615	78 lbs.	14



*8" or longer includes center leg support

For 10" Wide Shelving Use 12" Models & Price. Replace "12" with "10" (Example: DS-10-36)

Tapered Split Sleeve Installation & Numbered Posts



For 1" Rear Turn Up, add "R" after model # (Example: TS-12-60R) • For 15" Wide Shelving (w/ 1-5/8" Tubing) Use OTS/ODS Series

ADJUSTABLE 18" WIDE DOUBLE OVERSHELF WITH 6" OFFSET



Length	Model #	Price	Approx. Wt.	Approx. Cubes
3'	CDS-18-36	\$3714	24 lbs.	4
4'	CDS-18-48	3786	29 lbs.	5
5'	CDS-18-60	4261	35 lbs.	6
6'	CDS-18-72	4353	40 lbs.	7
7'	CDS-18-84	4446	46 lbs.	8
8'	CDS-18-96	4688	55 lbs.	10
9'	CDS-18-108	4967	60 lbs.	11
10'	CDS-18-120	5044	66 lbs.	12
11'	CDS-18-132	5247	72 lbs.	13
12'	CDS-18-144	5302	78 lbs.	14

18" & 24" WIDE TABLE MOUNTED SHELVING



SHELVING Specialty Shelving

For Existing Equipment For
SMART FABRICATION™ CHEF'S LINE

- Stainless Steel Shelving (1 Tier or 2 Tier Shelves)
- Stainless Steel Posts (1" Posts Available)
- Mounting Brackets Included

Customer To Specify Models Of Buyout Equipment.
Print Required.

Call For a Custom Quote

Quote Prints Available On Request
- A Service Only Advance Tabco Offer!
Call Our Estimating Department At 800-645-3166
or email smartFab@advancetabco.com



Single Tier Shelving					Double Tier Shelving								
Ft.	Approx. Cubes	18" WIDE	Price	Approx. Wt.	24" WIDE	Price	Approx. Wt.	18" WIDE	Price	Approx. Wt.	24" WIDE	Price	Approx. Wt.
4'	12	CU-18-48	\$2158	42 lbs.	CU-24-48	\$2668	55 lbs.	CU-18-48-2	\$4154	76 lbs.	CU-24-48-2	\$4569	114 lbs.
5'	15	CU-18-60	2228	53 lbs.	CU-24-60	2858	61 lbs.	CU-18-60-2	4352	95 lbs.	CU-24-60-2	4786	131 lbs.
6'	17	CU-18-72	2310	64 lbs.	CU-24-72	2983	70 lbs.	CU-18-72-2	4550	115 lbs.	CU-24-72-2	5004	152 lbs.
7'	20	CU-18-84	2617	75 lbs.	CU-24-84	3398	81 lbs.	CU-18-84-2	4938	135 lbs.	CU-24-84-2	5435	176 lbs.
8'	23	CU-18-96	2820	89 lbs.	CU-24-96	3658	98 lbs.	CU-18-96-2	5122	160 lbs.	CU-24-96-2	5634	207 lbs.
9'	26	CU-18-108	3042	95 lbs.	CU-24-108	4037	104 lbs.	CU-18-108-2	5347	121 lbs.	CU-24-108-2	5715	239 lbs.
10'	29	CU-18-120	3220	105 lbs.	CU-24-120	4344	113 lbs.	CU-18-120-2	5432	189 lbs.	CU-24-120-2	5800	283 lbs.
11'	32	CU-18-132	3396	118 lbs.	CU-24-132	4446	129 lbs.	CU-18-132-2	5431	212 lbs.	CU-24-132-2	5973	331 lbs.
12'	35	CU-18-144	3505	130 lbs.	CU-24-144	4948	146 lbs.	CU-18-144-2	5679	235 lbs.	CU-24-144-2	6249	387 lbs.

Shelving Modifications

Undermount Paper/Accessories Shelf

TA-117 \$386 /lin. ft.

Additional Fixed Partitions

(Specify Location For Factory Installation) TA-117A \$151 ea.

- 7" Wide x 12" High
- Two Adjustable Partitions To Create Separate Compartments

FACTORY INSTALLED ONLY

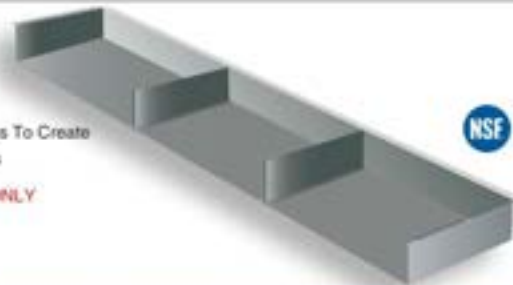

TA-9A	Partial 1" Turn-Up for all Table Mt. Shelves	\$62 /lin. ft.	TA-71	Heat Lamp Mounting Provision	\$228 ea.
TA-22A	Square Edge on Overshelf	144 ea.	TA-71A	Heat Lamp Remote Control Bracket	448 ea.
TA-26-10	Welded Wall Shelf Brackets for 10' Shelf	358 /shelf	TA-77	Check Minder Shelf Provision (Factory Install Only)	81 /lin. ft.
TA-26-12	Welded Wall Shelf Brackets for 12' Shelf	358 /shelf	TA-85	30" Wide CU Shelf (Add to price of 24" Shelf. For double tier, add twice)	288 /lin. ft.
TA-26-15	Welded Wall Shelf Brackets for 15' Shelf	358 /shelf	TA-99	16 Ga. S/S 304 Upgrade for Wall & Over Shelves	35 /lin. ft.
TA-26-18	Welded Wall Shelf Brackets for 18' Shelf	358 /shelf	TA-99A	14 Ga. S/S 304 Upgrade for Wall & Over Shelves	65 /lin. ft.
TA-33A	Customize Post Height (Specify Height)	70 /shelf	TA-100A	Bull Nose Edge On all 4 Sides of Shelf	144 ea.
TA-47	Shelf Mounting Bracket for Existing Table	131 /shelf	TA-102	24" x 24" Extension for Microwave or Computer Shelf (Add to OTS and ODS Shelves. See page 45)	595 ea.
TA-49	Wall Shelf 2" Offset	253 /shelf	TA-103	24" Wide PT Shelf (36" Min Length, Mid mount only. PT Series Shelf, see pg. 48. Add to 18" Wide Shelf)	177 /lin. ft.
TA-60	Special Sizing Charge for Shelves (Must Order Larger Unit to be Cut Down to Smaller Size)	N/C	TA-104	Add'l Length Over 12' - Add to 18" or 24" Shelf (CU Shelving Only. Maximum Length is 14' as Single Piece)	383 /lin. ft.
TA-62C	Duplex Electrical Outlet (Under Flat Top)	671 ea.			
TA-62D	GFI Duplex Outlet in a Doghouse Box	713 ea.			

SHELVING

Specialty Shelving



PASS-THRU SHELVING

Standard Pass-Thru Shelf

- "Hat Channel" Design Allows Shelf To Be Freely Positioned
- Includes Wall Mounting Brackets For Securing Shelf To Desired Position



Pass-Thru shown with Cantilever Brackets

Pass-Thru Shelf with Overshelf

- 1 CU Series Overshelf welded to a PA Series Pass-Thru shelf
- 1-5/8" Stainless Steel Tubing
- Shipped as Welded Set-Up



Pass-Thru with CU Series Shelf & Cantilever Bracket Shown

Pre-Wiring Available!
 Contact our Smart Fab Department at smartfab@advancetabco.com

18" WIDE	Price	24" WIDE	Price	Length	# of Brackets
PA-18-24	\$1444	PA-24-24	\$1625	24"	2
PA-18-36	1773	PA-24-36	1784	36"	2
PA-18-48	1929	PA-24-48	2409	48"	2
PA-18-60	2076	PA-24-60	2594	60"	2
PA-18-72	2149	PA-24-72	2779	72"	2
PA-18-84	2224	PA-24-84	3039	84"	3
PA-18-96	2302	PA-24-96	3252	96"	3
PA-18-108	2400	PA-24-108	3268	108"	3
PA-18-120	2444	PA-24-120	3312	120"	3
PA-18-132	2668	PA-24-132	3615	132"	4
PA-18-144	3039	PA-24-144	3879	144"	4

18" WIDE	Price	24" WIDE	Price	Length	# of Brackets
PA-18-48-2	\$3966	PA-24-48-2	\$5008	48"	2
PA-18-60-2	4184	PA-24-60-2	5376	60"	2
PA-18-72-2	4332	PA-24-72-2	5680	72"	2
PA-18-84-2	4699	PA-24-84-2	6351	84"	3
PA-18-96-2	4973	PA-24-96-2	6813	96"	3
PA-18-108-2	5279	PA-24-108-2	7207	108"	3
PA-18-120-2	5496	PA-24-120-2	7564	120"	3
PA-18-132-2	5885	PA-24-132-2	7956	132"	4
PA-18-144-2	6354	PA-24-144-2	8710	144"	4

Mounting Brackets Included With Pass-Thru Shelving



"2" x 4" - L Bracket For 18" Wide Shelves



"5" x 5" - Cantilever Bracket For 24" Wide Shelves

PASS-THRU MODIFICATION

Includes Side & Top • Minimum Length = 36"

Pass-Thru Frame

Length	Model	Price
36"	TA-84F-36	\$1780
48"	TA-84F-48	1975
60"	TA-84F-60	2176
72"	TA-84F-72	2329
84"	TA-84F-84	2450



Print Required For Proper Location

Electrical Utility Chases

Call For Wiring Installation!



FLOOR CHASE



CEILING CHASE

- Conceals Wires
- Removable Panel For Wire Access.
- Wiring Available Upon Request.

Available only for CU Series & OTS Series Shelving (Pages 68-69)

MODEL	FEED TYPE	PRICE
UCC-1	Ceiling	\$2353
UCF-1	Floor	2080

Print required for proper chase location. Utility Chase is FACTORY INSTALLATION only.



PIPE CHASE

- Conceals Wires For Heat Lamps.
- Required Installation Of Buyout Equipment

Consult Factory for Wiring

MODEL	PRICE
PC-1	\$924 ea.



SHELVING

Wall Mounted Shelving

• 1 1/2" Rolled Rim With A 1 1/2" Turn-Up At Rear Ends Are Turned Down Square

16 GA. WALL MOUNTED SHELVING

304 Type Stainless Steel

Length	10" WIDE	Price	12" WIDE	Price	15" WIDE	Price	18" WIDE	Price	Approx. Wt.	Approx. Cubes
2'	WS-10-24-16	\$496	WS-12-24-16	\$512	WS-15-24-16	\$840	WS-18-24-16	\$1166	10 lbs.	3
30"	-	-	WS-12-30-16	\$85	-	-	-	-	11 lbs.	3
3'	WS-10-36-16	\$534	WS-12-36-16	\$587	WS-15-36-16	\$893	WS-18-36-16	\$1220	12 lbs.	4
42"	-	-	WS-12-42-16	\$660	-	-	-	-	13 lbs.	5
4'	WS-10-48-16	\$562	WS-12-48-16	\$663	WS-15-48-16	\$948	WS-18-48-16	\$1272	14 lbs.	5
5'	WS-10-60-16	\$626	WS-12-60-16	\$727	WS-15-60-16	\$1085	WS-18-60-16	\$1408	17 lbs.	6
6'	WS-10-72-16	\$673	WS-12-72-16	\$772	WS-15-72-16	\$1230	WS-18-72-16	\$1547	19 lbs.	7
7'	WS-10-84-16	\$770	WS-12-84-16	\$854	WS-15-84-16	\$1322	WS-18-84-16	\$1623	22 lbs.	8
8'	WS-10-96-16	\$881	WS-12-96-16	\$936	WS-15-96-16	\$1528	WS-18-96-16	\$1690	26 lbs.	10
9'	WS-10-108-16	\$967	WS-12-108-16	\$1016	WS-15-108-16	\$1642	WS-18-108-16	\$1826	28 lbs.	11
10'	WS-10-120-16	\$1090	WS-12-120-16	\$1159	WS-15-120-16	\$1690	WS-18-120-16	\$2031	31 lbs.	12
11'	WS-10-132-16	\$1077	WS-12-132-16	\$1219	WS-15-132-16	\$1937	WS-18-132-16	\$2109	35 lbs.	13
12'	WS-10-144-16	\$1162	WS-12-144-16	\$1251	WS-15-144-16	\$2060	WS-18-144-16	\$2187	38 lbs.	14

18 GA. WALL MOUNTED SHELVING

430 Type Stainless Steel

Length	10" WIDE	Price	12" WIDE	Price	15" WIDE	Price	18" WIDE	Price	Approx. Wt.	Approx. Cubes
2'	WS-10-24	\$397	WS-12-24	\$409	WS-15-24	\$474	WS-18-24	\$860	10 lbs.	3
30"	-	-	WS-12-30	\$464	-	-	-	-	12 lbs.	4
3'	WS-10-36	\$420	WS-12-36	\$466	WS-15-36	\$535	WS-18-36	\$904	12 lbs.	4
42"	-	-	WS-12-42	\$525	-	-	-	-	14 lbs.	5
4'	WS-10-48	\$449	WS-12-48	\$527	WS-15-48	\$605	WS-18-48	\$1024	14 lbs.	5
5'	WS-10-60	\$521	WS-12-60	\$581	WS-15-60	\$644	WS-18-60	\$1062	17 lbs.	6
6'	WS-10-72	\$564	WS-12-72	\$620	WS-15-72	\$697	WS-18-72	\$1159	19 lbs.	7
7'	WS-10-84	\$614	WS-12-84	\$684	WS-15-84	\$713	WS-18-84	\$1266	22 lbs.	8
8'	WS-10-96	\$710	WS-12-96	\$748	WS-15-96	\$827	WS-18-96	\$1341	26 lbs.	10
9'	WS-10-108	\$736	WS-12-108	\$814	WS-15-108	\$1106	WS-18-108	\$1561	28 lbs.	11
10'	WS-10-120	\$879	WS-12-120	\$927	WS-15-120	\$1136	WS-18-120	\$1623	31 lbs.	12
11'	WS-10-132	\$905	WS-12-132	\$974	WS-15-132	\$1297	WS-18-132	\$1705	35 lbs.	13
12'	WS-10-144	\$943	WS-12-144	\$999	WS-15-144	\$1373	WS-18-144	\$1785	38 lbs.	14

TA-22A	Square Edge Shelf	\$144 ea.	TA-60	Special Sizing Charge For Shelves (Must Order Larger Unit To Be Cut Down To Smaller Size)	N/C
TA-26-10	Weld Support Brackets To Wall Shelf For 10" Deep Wall Shelves	\$358 ea.	TA-71	Heat Lamp Mounting Provision	\$228 ea.
TA-26-12	Weld Support Brackets To Wall Shelf For 12" Deep Wall Shelves	\$358 ea.	TA-77	Check Minder Provision On Any Shelf	\$81 /lin. ft.
TA-26-15	Weld Support Brackets To Wall Shelf For 15" Deep Wall Shelves	\$358 ea.	TA-99A	14 Ga. S/S 304 Upgrade For Wall & Over Shelves	\$65 /lin. ft.
TA-26-18	Weld Support Brackets To Wall Shelf For 18" Deep Wall Shelves	\$358 ea.	TA-100A	Bullnose Edge On All 4 Sides Of Shelf	\$144 ea.
TA-49	2" Wall Shelf Offset	\$253 /shelf			

K.D. WALL SHELVES

Length	STAINLESS STEEL w/ Stainless Steel Brackets		ALUMINUM w/ Aluminum Brackets		Approx. Wt.	Approx. Cubes
	Model #	Price	Model #	Price		
2'	WS-KD-24	\$349	AWS-KD-24	\$286	10 lbs.	2
3'	WS-KD-36	\$362	AWS-KD-36	\$309	12 lbs.	3
4'	WS-KD-48	\$403	AWS-KD-48	\$343	14 lbs.	4
5'	WS-KD-60	\$452	AWS-KD-60	\$370	17 lbs.	5



Tab-Lock Design

Width Of Shelf Is 11-1/8"

Single Shipping Container Can Be Shipped U.P.S.



Custom Sizes are Available. Contact Our SMART FABRICATION™ Department, 800-845-3166

SHELVING

Wall Mounted Shelving



WALL SHELVES

Slotted Cook Line Wall Shelf



- Heavy Duty
- 304 Type Stainless Steel
- 21" Wide
- 1 1/2" Square Tubes
- 1 1/4" Spacing
- Tubular Support Brackets (Shipped Loose To Suit Wall Stud Location)

TA-26-21 **\$480 per shelf**
Optional Factory Welded Shelf Brackets (Paint Required)



L	Model #	Price	# of Brackets	Approx. Wt.	Approx. Cubes
48"	DT21-4	\$5134	2	90 lbs.	6
72"	DT21-6	7701	3	105 lbs.	8
96"	DT21-8	10266	3	145 lbs.	10
120"	DT21-10	12835	4	190 lbs.	13
144"	DT21-12	15399	4	210 lbs.	15

NOTE: Recommend Field Welding Brackets To Underside Of Cook Line Shelf

Built-In Check Minder



Floating Ball Mechanism Quickly Gras Checks And Holds Them In Place

L	12" WIDE	Price	Approx. Wt.	Approx. Cubes
3'	WS-12-36CM	\$551	15 lbs.	4
4'	WS-12-48CM	609	19 lbs.	5
5'	WS-12-60CM	658	21 lbs.	6
6'	WS-12-72CM	702	25 lbs.	7
8'	WS-12-96CM	831	32 lbs.	10

Under Mounted Multi-Purpose Shelf

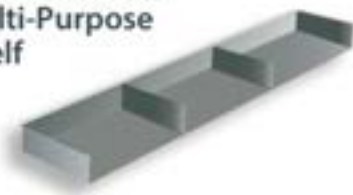

- Heavy Duty
- Mounts below shelving or table top
- Supplied with mounting holes.
- 1 stationary divider included 36" lengths & under 2 stationary dividers included over 36" lengths

Model #	Price	Approx. Wt.
TA-117	\$386 lin. ft.	22 lbs. per sq. ft.

TA-117A **\$151 ea.**
Additional Dividers



FACTORY INSTALLED ONLY

with Built-In Pot Rack



Length	12" WIDE	Price	15" WIDE	Price	18" WIDE	Price	# of Hooks	Approx. Wt.	Approx. Cubes
3'	PS-12-36	\$1118	PS-15-36	\$1349	PS-18-36	\$1716	6	30 lbs.	5
4'	PS-12-48	1178	PS-15-48	1417	PS-18-48	1837	6	40 lbs.	6
5'	PS-12-60	1229	PS-15-60	1456	PS-18-60	1876	9	50 lbs.	7
6'	PS-12-72	1269	PS-15-72	1507	PS-18-72	1970	9	60 lbs.	8
7'	PS-12-84	1332	PS-15-84	1528	PS-18-84	2080	9	70 lbs.	10
8'	PS-12-96	1398	PS-15-96	1639	PS-18-96	2153	9	80 lbs.	11
9'	PS-12-108	1465	PS-15-108	1916	PS-18-108	2372	9	90 lbs.	12
10'	PS-12-120	1577	PS-15-120	1948	PS-18-120	2434	9	100 lbs.	13
11'	PS-12-132	1623	PS-15-132	2109	PS-18-132	2518	9	110 lbs.	14
12'	PS-12-144	1650	PS-15-144	2187	PS-18-144	2597	9	120 lbs.	26

TA-60 Special Sizing Charge for Wall Shelves
TA-99 16 ga. 304 Upgrade for Wall and Over Shelves
TA-99A 14 Ga. S/S 304 Upgrade for Wall & Over Shelves

N/C - Add to next longer shelf
\$35 / lin. ft.
65 / lin. ft.



FOR CHECK MINDER PROVISION
On Any Shelf Use

TA-77
\$81/lin. ft.



Wall Shelf w/Multipurpose Undershelf



- 5 1/2" Undershelf
- Upper & Lower Grommet Holes



Size W x L	Model #	Price	Approx. Wt.	Approx. Cubes
24" x 24"	MS-24-24-PS	\$2039	58 lbs.	11
24" x 36"	MS-24-36-PS	2384	85 lbs.	16
24" x 48"	MS-24-48-PS	2731	110 lbs.	21

78

Microwave Shelf



Size W x L	Model #	Price	Approx. Wt.	Approx. Cubes
18" x 24"	MS-18-24	\$779	27 lbs.	5
24" x 24"	MS-24-24	883	32 lbs.	5
24" x 36"	MS-24-36	1230	38 lbs.	7
28" x 30"	MS-20-30	1139	36 lbs.	5

TA-108 **\$191**
2" Hole with Grommet For Appliance Cord.
(Please Specify Hole Size And Location)



8" Wide Utility Shelf

Length	Model #	Price	Approx. Wt.	Approx. Cubes
24"	K-245	\$1104	50 lbs.	1
36"	K-246	1253	55 lbs.	2

SHELVING

Shelving & Modifications

18" WIDE CEILING MOUNTED SHELVING

= Ship Via UPS

Single Shelf

Length	Model #	Price	Approx. Wt.	Approx. Cubes
3'	CM-18-36	\$3770	24 lbs.	4
4'	CM-18-48	4043	29 lbs.	5
5'	CM-18-60	4309	35 lbs.	6
6'	CM-18-72	4578	40 lbs.	7
7'	CM-18-84	4585	46 lbs.	8
8'	CM-18-96	4703	51 lbs.	9

Double Shelves

Length	Model #	Price	Approx. Wt.	Approx. Cubes
3'	DCM-18-36	\$4846	55 lbs.	5
4'	DCM-18-48	5655	60 lbs.	6
5'	DCM-18-60	5924	66 lbs.	7
6'	DCM-18-72	6734	72 lbs.	8
7'	DCM-18-84	6829	78 lbs.	9
8'	DCM-18-96	7052	84 lbs.	10

- Stainless Steel
- 1 5/8" Stainless Steel Posts
- Shipped KD
- Load Capacity is 5 lbs. per sq. ft. (Evenly Distributed)

CUSTOMER MUST SPECIFY CEILING HEIGHT



SHELVING MODIFICATIONS

FACTORY INSTALLED ONLY

Printer Shelf

- Heavy gauge stainless steel
- 8"x16" Printer Deck
- 10" height
- 1 Data Port Receptacle
- 1 Electrical Receptacle
- Rear Gem Box with Removable Enclosure
- Turned up front edge to hold Printer in place



PRT-1 \$1223/shelf Back of Shelf Shown

Check Minder



- Extruded Anodized Aluminum
- Holds checks with ease
- Floating ball mechanism quickly grabs checks & holds them in place
- Mounts to any shelf

TA-77 \$81/lin. ft.
TA-77A \$58/lin. ft.

Concealer for Heat Lamp.
(Requires a TA-77)

Microwave Shelf Extension



24" Front to Back
1-5/8" Posts

Use the full length of OTS Shelves found on page 74 and then add TA-102 \$595 extension. Specify Right or Left.

Table Mounted Equipment Shelf



1-5/8" Posts

L	Model #	Price	Approx. Wt.	Approx. Cubes
2'	MST-24-24	\$1613	32 lbs.	1
3'	MST-24-36	1885	38 lbs.	2

6" Shelf Offset



- Posts located towards rear shelf
- Provides shelf reach
- Available for 18" or Wider shelving Only (CU Series Shelving)

TA-120 \$178/Per level

Accessories

Check Minder Accessory



- Holds Checks With Ease
- Floating Ball Mechanism Quickly Grabs Checks & Holds Them in Place
- Mounts To Existing Wall Or Shelf

Length	Model #	Price	Approx. Wt.
2'	CM-24	\$77	1.5 lbs.
3'	CM-36	97	2.25 lbs.
4'	CM-48	111	3 lbs.
5'	CM-60	125	4.25 lbs.

Wall Cap



- 16 ga., 304 Stainless Steel
- 2" x Wall Thickness x 2" x Height

Model #	Price
WALLCAP	\$79 Lin. ft.

MUST SPECIFY:
Wall thickness (maximum 6")
Height (Maximum of 10 feet)
Minimum charge 4 linear feet

Bumper Guards



- 16 ga., 304 Stainless Steel
- Bracket Included

Model #	Size	Price
BG-48	2" x 4" x 48"	\$298
BG-60	2" x 4" x 60"	403

Corner Guards

- 16 ga., 304 Stainless Steel
- Adhesive Tape Backing

2" x 2"		
Model #	Size	Price
CG-48	2" x 2" x 48"	\$202
CG-60	2" x 2" x 60"	266
CG-72	2" x 2" x 72"	296
CG-84	2" x 2" x 84"	349
CG-96	2" x 2" x 96"	382
CG-120	2" x 2" x 120"	414
4" x 4"		
OCG-48-SS	4" x 4" x 48"	382

POT RACKS

Adjustable Pot Rack Components



#1 HOW TO ORDER
Select from 3 Mounting Provisions

#2 Choose Desired Components



MIX & MATCH to Maximize Your Work Area. Components are Adjustable. You set the Height to Meet Your Demanding Requirement.

SPECIFY MOUNTING PROVISION

FOR MID MOUNT
Add TA-228 N/C



FOR REAR MOUNT
ADD TA-229 N/C



FOR SPLASH MOUNT
ADD TA-227 N/C



Pot Racks (Includes Utensil Rack)						Utensil Racks				
Length	Model #	# of Pot Hooks	Price	Approx. WL	Approx. Cubes	Model #	# of Pot Hooks	Price	Approx. WL	Approx. Cubes
36"	SCT-36	12	\$2033	30	5	AUR-36	6	\$768	30	2
48"	SCT-48	12	2109	34	6	AUR-48	6	780	34	3
60"	SCT-60	18	2167	37	7	AUR-60	9	836	37	3
72"	SCT-72	18	2987	46	9	AUR-72	9	876	46	4
84"	SCT-84	18	3059	50	10	AUR-84	9	1026	50	5
96"	SCT-96	18	3267	55	12	AUR-96	9	1123	55	5
108"	SCT-108	18	3978	60	13	AUR-108	9	1412	60	6
120"	SCT-120	18	4310	65	15	AUR-120	9	1498	65	7
132"	SCT-132	18	4429	68	16	AUR-132	9	1696	68	7
144"	SCT-144	18	4516	72	18	AUR-144	9	1883	72	8
36"	SWT-36	12	\$1616	30	5	AUR-36	6	\$768	30	2
48"	SWT-48	12	1657	34	6	AUR-48	6	780	34	3
60"	SWT-60	18	1675	37	7	AUR-60	9	836	37	3
72"	SWT-72	18	1696	46	9	AUR-72	9	876	46	4
84"	SWT-84	18	2033	50	10	AUR-84	9	1026	50	5
96"	SWT-96	18	2070	55	12	AUR-96	9	1123	55	5
108"	SWT-108	18	2460	60	13	AUR-108	9	1412	60	6
120"	SWT-120	18	2487	65	15	AUR-120	9	1498	65	7
132"	SWT-132	18	2547	68	16	AUR-132	9	1696	68	7
144"	SWT-144	18	2606	72	18	AUR-144	9	1883	72	8
36"	SWT-36	12	\$1616	30	5	AUR-36	6	\$768	30	2
48"	SWT-48	12	1657	34	6	AUR-48	6	780	34	3
60"	SWT-60	18	1675	37	7	AUR-60	9	836	37	3
72"	SWT-72	18	1696	46	9	AUR-72	9	876	46	4
84"	SWT-84	18	2033	50	10	AUR-84	9	1026	50	5
96"	SWT-96	18	2070	55	12	AUR-96	9	1123	55	5
108"	SWT-108	18	2460	60	13	AUR-108	9	1412	60	6
120"	SWT-120	18	2487	65	15	AUR-120	9	1498	65	7
132"	SWT-132	18	2547	68	16	AUR-132	9	1696	68	7
144"	SWT-144	18	2606	72	18	AUR-144	9	1883	72	8

Pot Racks 8' Or Longer, Include Center Leg Support

SHELVING

Adjustable Shelving Components

Convert Your Table into an Effective Work Station



ADD - CHANGE - MODIFY with Components to Meet the Demanding Prep-Requirements of an Upgrading or Changing Food Service Environment

Adjustable Shelves

Length	10" WIDE	Price	12" WIDE	Price	15" WIDE	Price	18" WIDE	Price	Approx. Wt.	Approx. Cubes
36"	PT-10-36	\$678	PT-12-36	\$711	PT-15-36	\$796	PT-18-36	\$887	30	2
48"	PT-10-48	728	PT-12-48	760	PT-15-48	850	PT-18-48	950	34	3
60"	PT-10-60	763	PT-12-60	814	PT-15-60	912	PT-18-60	1018	37	3
72"	PT-10-72	800	PT-12-72	860	PT-15-72	964	PT-18-72	1076	46	4
84"	PT-10-84	836	PT-12-84	904	PT-15-84	1013	PT-18-84	1130	50	5
96"	PT-10-96	1170	PT-12-96	1264	PT-15-96	1417	PT-18-96	1581	55	5
108"	PT-10-108	1312	PT-12-108	1417	PT-15-108	1585	PT-18-108	1770	60	6
120"	PT-10-120	1467	PT-12-120	1585	PT-15-120	1778	PT-18-120	1983	65	7
132"	PT-10-132	1643	PT-12-132	1778	PT-15-132	1990	PT-18-132	2222	68	7
144"	PT-10-144	1841	PT-12-144	1990	PT-15-144	2229	PT-18-144	2487	72	8
36"	PT-10R-36	\$800	PT-12R-36	\$832	PT-15R-36	\$932	PT-18R-36	\$1040	30	2
48"	PT-10R-48	838	PT-12R-48	886	PT-15R-48	994	PT-18R-48	1109	34	3
60"	PT-10R-60	886	PT-12R-60	943	PT-15R-60	1056	PT-18R-60	1179	37	3
72"	PT-10R-72	936	PT-12R-72	999	PT-15R-72	1119	PT-18R-72	1250	46	4
84"	PT-10R-84	985	PT-12R-84	1058	PT-15R-84	1185	PT-18R-84	1324	50	5
96"	PT-10R-96	1376	PT-12R-96	1482	PT-15R-96	1661	PT-18R-96	1852	55	5
108"	PT-10R-108	1542	PT-12R-108	1661	PT-15R-108	1859	PT-18R-108	2075	60	6
120"	PT-10R-120	1727	PT-12R-120	1859	PT-15R-120	2083	PT-18R-120	2324	65	7
132"	PT-10R-132	1936	PT-12R-132	2083	PT-15R-132	2333	PT-18R-132	2605	68	7
144"	PT-10R-144	2167	PT-12R-144	2333	PT-15R-144	2611	PT-18R-144	2914	72	8
36"	PT-10S-36	\$1020	PT-12S-36	\$1058	PT-15S-36	\$1185	PT-18S-36	\$1324	30	2
48"	PT-10S-48	1075	PT-12S-48	1117	PT-15S-48	1251	PT-18S-48	1396	34	3
60"	PT-10S-60	1117	PT-12S-60	1166	PT-15S-60	1305	PT-18S-60	1459	37	3
72"	PT-10S-72	1162	PT-12S-72	1230	PT-15S-72	1377	PT-18S-72	1538	46	4
84"	PT-10S-84	1213	PT-12S-84	1286	PT-15S-84	1439	PT-18S-84	1608	50	5
96"	PT-10S-96	1701	PT-12S-96	1801	PT-15S-96	2016	PT-18S-96	2251	55	5
108"	PT-10S-108	1870	PT-12S-108	1982	PT-15S-108	2220	PT-18S-108	2475	60	6
120"	PT-10S-120	2057	PT-12S-120	2178	PT-15S-120	2441	PT-18S-120	2724	65	7
132"	PT-10S-132	2263	PT-12S-132	2398	PT-15S-132	2684	PT-18S-132	2996	68	7
144"	PT-10S-144	2488	PT-12S-144	2638	PT-15S-144	2954	PT-18S-144	3295	72	8

Shelves 8' Or Longer, Include Center Leg Support

POT RACKS

Additional Pot Racks

STAINLESS STEEL WALL MOUNTED POT RACKS

Includes Pot Hooks

Single Bar

Stainless Steel			Aluminum				
Length	Model #	Price	Model #	Price	# Of Hooks	Wt.	Cu.
2'	NOT AVAILABLE		ALW-24	\$469	6	5 lbs.	1.0
3'	SW1-36	\$880	ALW-36	581	6	6 lbs.	1.5
4'	SW1-48	905	ALW-48	633	6	7 lbs.	2.0
5'	SW1-60	969					2.5
6'	SW1-72	961					3.0
7'	SW1-84	985					3.5
8'	SW1-96	1082					4.0
9'	SW1-108	1191					4.5
10'	SW1-120	1295					5.0

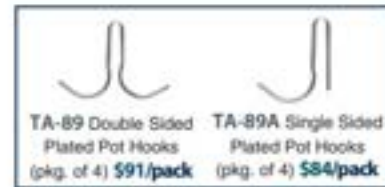

SW1-36 Shown

Double Bar



Length	Model #	Price	# Of Hooks	Wt.	Cu.
2'	SW-24	\$1219	12	18 lbs.	4
3'	SW-36	1320	12	22 lbs.	5
4'	SW-48	1364	12	26 lbs.	6
5'	SW-60	1466	18	30 lbs.	7
6'	SW-72	1540	18	34 lbs.	9
7'	SW-84	1701	18	44 lbs.	10
8'	SW-96	1764	18	48 lbs.	12
9'	SW-108	2086	18	52 lbs.	13
10'	SW-120	2281	18	56 lbs.	15
11'	SW-132	2475	18	60 lbs.	16
12'	SW-144	2617	18	64 lbs.	18



SW-36 Shown

CEILING MOUNTED STAINLESS STEEL POT RACKS

Hangs 36" From Ceiling • Includes Pot Hooks



Length	Model #	Price	# Of Hooks	Wt.	Cu.
3'	SC-36	\$2265	12	42 lbs.	5
4'	SC-48	2308	12	48 lbs.	6
5'	SC-60	2404	18	54 lbs.	7
6'	SC-72	2508	18	60 lbs.	9
7'	SC-84	2796	18	66 lbs.	10
8'	SC-96	3165	18	80 lbs.	12
9'	SC-108	3528	18	86 lbs.	13
10'	SC-120	3950	18	92 lbs.	15
11'	SC-132	4162	18	98 lbs.	16
12'	SC-144	4621	18	104 lbs.	18

TA-9B Stainless Steel Flat Bar in lieu of Chain \$414/pot rack

LEG MOUNTED POT RACK

For 30" Wide Tables

Includes 6 Pot Hooks Per Unit



Stainless Steel

UB-30
\$579
Wt. 10 lbs.

For Adjustable Pot Rack Components
See Page 80

DISHTABLE STANDARDS



Shown with 8" Deep Sink Bowl, Pre-rinse Basket & Slide Bar

Features and Benefits

- 3/4" Radius Corner Sink Bowls
- 10 1/2" Tile Edge Backsplash
- 1 5/8" Tubular Legs
- Economical Savings
- Satin Finish

SPEC-LINE "30" Series

- 14 ga. 304 Stainless Steel Top
- Stainless Steel Cross Bracing on Sides
- 16 ga. 304 Stainless Steel Legs & Adjust. Bullet Feet
- 10 1/2" Backsplash
- 8" Deep Sink Bowls (Soil Units)



STANDARD "70" Series

- 16 ga. 304 Stainless Steel Top
- Stainless Steel Cross Bracing on Sides
- Stainless Steel Legs and Adjust. Bullet Feet
- 10 1/2" Backsplash
- 5" Deep Sink Bowls (Soil Units)



SUPERSAVER "60" Series

- 16 ga. 304 Stainless Steel Top
- Galvanized Legs & Adjust. Plastic Bullet Feet
- 10 1/2" Backsplash
- 5" Deep Sink Bowls (Soil Units)



WHEN PLACING AN ORDER, PLEASE PROVIDE THE DISH MACHINE MODEL NUMBER TO ENSURE PROPER DISHTABLE COMPATIBILITY.

Due to some machine manufacturer's recommendations for specific service access, the following modifications will apply...

DTA-76 (Relocate sink location)

Dish Machines that require a DTA-76:

ES-4400, ES-6600, WH-series, APEX TSC-V
CMA 180 (Right-side), 44, 66
Hobart AM-15 (corner configuration) C-series, CL-series,
CCS-66/77/86/110, CRS-series
Jackson AJ-series, TS-series, TSC-series
Meiko K-series
Stero SCT-series

DTA-76: No Charge

DTA-78 (Notch in backsplash to clear handle)

Dish Machines that require a DTA-78:

ADS HT-25, SS-25
Blakeslee D-8, D-9
Ecolab ES-4000
Electrolux WT65
Hobart AM-15 (Corner Configuration)
DTA-78: \$204

This is A Partial List. Please Refer To Our "Product Support" Section At www.advancetabco.com For Updates.

DISHTABLES

Soil Dishtables



ATTENTION:
See Dish Machine Information on Pg. 83 to ensure proper compatibility

STRAIGHT SOIL DISHTABLES

Spec-Line 530 Series Standard 570 Series Super Saver 560 Series
 14 Ga. 16 Ga. 16 Ga. w/ Galvanized Legs

Nominal Size	Length	Model #	Price	Model #	Price	Model #	Price	Approx. Weight	Approx. Cu. Ft.
3 Fl.	35"	DTS-530-36LorR	\$4963	DTS-570-36LorR	\$4187	DTS-560-36LorR	\$3984	70 lbs.	12
4 Fl.	47"	DTS-530-48LorR	5203	DTS-570-48LorR	4324	DTS-560-48LorR	4128	85 lbs.	17
5 Fl.	59"	DTS-530-60LorR	5321	DTS-570-60LorR	4469	DTS-560-60LorR	4271	100 lbs.	19
6 Fl.	71"	DTS-530-72LorR	5530	DTS-570-72LorR	4699	DTS-560-72LorR	4500	115 lbs.	23
7 Fl.	83"	DTS-530-84LorR	5689	DTS-570-84LorR	5041	DTS-560-84LorR	4754	125 lbs.	27
8 Fl.	95"	DTS-530-96LorR	5770	DTS-570-96LorR	5350	DTS-560-96LorR	4835	135 lbs.	31
9 Fl.	107"	DTS-530-108LorR	6852	DTS-570-108LorR	5755	DTS-560-108LorR	5517	235 lbs.	45
10 Fl.	119"	DTS-530-120LorR	7332	DTS-570-120LorR	6326	DTS-560-120LorR	6043	290 lbs.	50
12 Fl.	143"	DTS-530-144LorR	8487	DTS-570-144LorR	6933	DTS-560-144LorR	6651	300 lbs.	60

Faucet Holes are Splash Mounted 8" O.C.



*Please Sink location and machine opening may require DTA-76 modification to conform to Dishmachine requirements.

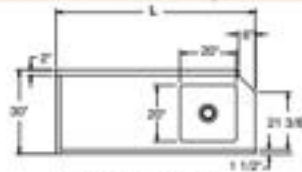

LEFT SOIL TABLE

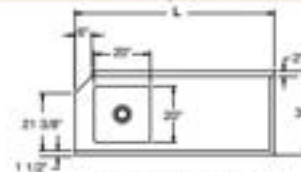

RIGHT SOIL TABLE



CORNER SOIL DISHTABLES

Spec-Line K30 Series Standard K70 Series Super Saver K60 Series
 14 Ga. 16 Ga. 16 Ga. w/ Galvanized Legs

Nominal Size	Length	Model #	Price	Model #	Price	Model #	Price	Approx. Weight	Approx. Cu. Ft.
4 Fl.	47"	DTS-K30-48LorR	\$9119	DTS-K70-48LorR	\$8337	DTS-K60-48LorR	\$7968	128 lbs.	29
5 Fl.	59"	DTS-K30-60LorR	9336	DTS-K70-60LorR	8472	DTS-K60-60LorR	8151	138 lbs.	37
6 Fl.	71"	DTS-K30-72LorR	9501	DTS-K70-72LorR	8683	DTS-K60-72LorR	8380	149 lbs.	44
7 Fl.	83"	DTS-K30-84LorR	9765	DTS-K70-84LorR	8877	DTS-K60-84LorR	8643	163 lbs.	51
8 Fl.	95"	DTS-K30-96LorR	9928	DTS-K70-96LorR	9097	DTS-K60-96LorR	8731	182 lbs.	58
9 Fl.	107"	DTS-K30-108LorR	10291	DTS-K70-108LorR	9562	DTS-K60-108LorR	9115	255 lbs.	83
10 Fl.	119"	DTS-K30-120LorR	10789	DTS-K70-120LorR	10388	DTS-K60-120LorR	9321	380 lbs.	92
12 Fl.	143"	DTS-K30-144LorR	11919	DTS-K70-144LorR	10075	DTS-K60-144LorR	10720	390 lbs.	110

Faucet Holes are Splash Mounted 8" O.C.



*Please Sink location and machine opening may require DTA-76 modification to conform to Dishmachine requirements.



LEFT CORNER SOIL TABLE

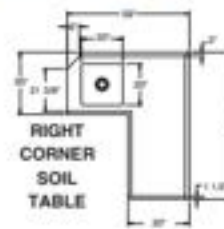

RIGHT CORNER SOIL TABLE

ATTENTION:
See Dish Machine Information on Pg. 83 to ensure proper compatibility



DISHTABLES

Soil Dishtables

ISLAND SOIL DISHTABLES

Spec-Line G30 Series Standard G70 Series Super Saver G60 Series
 14 Ga. 16 Ga. 16 Ga. w/ Galvanized Legs

Nominal Size	Length	Model #	Price	Model #	Price	Model #	Price	Approx. Weight	Approx. Cu. Ft.
4 FL.	47"	DTS-G30-48LorR	\$8539	DTS-G70-48LorR	\$7821	DTS-G60-48LorR	\$7478	129 lbs.	29
5 FL.	59"	DTS-G30-60LorR	8733	DTS-G70-60LorR	7964	DTS-G60-60LorR	7651	138 lbs.	37
6 FL.	71"	DTS-G30-72LorR	8958	DTS-G70-72LorR	8151	DTS-G60-72LorR	7878	150 lbs.	44
7 FL.	83"	DTS-G30-84LorR	9150	DTS-G70-84LorR	8391	DTS-G60-84LorR	8131	162 lbs.	51
8 FL.	95"	DTS-G30-96LorR	9309	DTS-G70-96LorR	8565	DTS-G60-96LorR	8212	178 lbs.	58
9 FL.	107"	DTS-G30-108LorR	9551	DTS-G70-108LorR	8979	DTS-G60-108LorR	8815	335 lbs.	83
10 FL.	119"	DTS-G30-120LorR	9951	DTS-G70-120LorR	9744	DTS-G60-120LorR	9562	365 lbs.	92
12 FL.	143"	DTS-G30-144LorR	10493	DTS-G70-144LorR	10285	DTS-G60-144LorR	10119	380 lbs.	110



*Premise Sink location and machine opening may require DTA-76 modification to conform to Dishmachine requirements.



LEFT ISLAND SOIL TABLE



RIGHT ISLAND SOIL TABLE

Faucet Holes are Splash Mounted 8" O.C.

DISHLANDING SOIL DISHTABLES

Spec-Line D30 Series Standard D70 Series Super Saver D60 Series
 14 Ga. 16 Ga. 16 Ga. w/ Galvanized Legs

Nominal Size	Length	Model #	Price	Model #	Price	Model #	Price	Approx. Weight	Approx. Cu. Ft.
4 FL.	47"	DTS-D30-48LorR	\$10225	DTS-D70-48LorR	\$9314	DTS-D60-48LorR	\$9117	139 lbs.	33
5 FL.	59"	DTS-D30-60LorR	10439	DTS-D70-60LorR	9504	DTS-D60-60LorR	9357	147 lbs.	41
6 FL.	71"	DTS-D30-72LorR	10712	DTS-D70-72LorR	9716	DTS-D60-72LorR	9539	160 lbs.	50
7 FL.	83"	DTS-D30-84LorR	11040	DTS-D70-84LorR	9932	DTS-D60-84LorR	9757	175 lbs.	58
8 FL.	95"	DTS-D30-96LorR	11117	DTS-D70-96LorR	10156	DTS-D60-96LorR	9935	205 lbs.	68
9 FL.	107"	DTS-D30-108LorR	11642	DTS-D70-108LorR	10382	DTS-D60-108LorR	10167	320 lbs.	93
10 FL.	119"	DTS-D30-120LorR	12112	DTS-D70-120LorR	10986	DTS-D60-120LorR	10720	365 lbs.	103
12 FL.	143"	DTS-D30-144LorR	12641	DTS-D70-144LorR	11458	DTS-D60-144LorR	11250	390 lbs.	123



*Premise Sink location and machine opening may require DTA-76 modification to conform to Dishmachine requirements.



LEFT DISHLANDING SOIL TABLE



RIGHT DISHLANDING SOIL TABLE

DISHTABLES

Clean Dishtables

ATTENTION:
See Dish Machine Information on Pg. 83 to ensure proper compatibility

STRAIGHT CLEAN DISHTABLES

Spec-Line 530 Series Standard 570 Series Super Saver 560 Series
 14 Ga. 16 Ga. 16 Ga. w/ Galvanized Legs

Nominal Size	Length	Model #	Price	Model #	Price	Model #	Price	Approx. Weight	Approx. Cu. Ft.
2 Fl.	23"	DTC-530-24LorR	\$2450	DTC-570-24LorR	\$2314	DTC-560-24LorR	\$2107	35 lbs.	12
3 Fl.	35"	DTC-530-36LorR	2969	DTC-570-36LorR	2658	DTC-560-36LorR	2451	45 lbs.	12
4 Fl.	47"	DTC-530-48LorR	3109	DTC-570-48LorR	2894	DTC-560-48LorR	2687	60 lbs.	17
5 Fl.	59"	DTC-530-60LorR	3313	DTC-570-60LorR	3066	DTC-560-60LorR	2856	70 lbs.	19
6 Fl.	71"	DTC-530-72LorR	3495	DTC-570-72LorR	3213	DTC-560-72LorR	3007	85 lbs.	23
7 Fl.	83"	DTC-530-84LorR	4243	DTC-570-84LorR	3570	DTC-560-84LorR	3278	100 lbs.	27
8 Fl.	95"	DTC-530-96LorR	4440	DTC-570-96LorR	3871	DTC-560-96LorR	3358	110 lbs.	31
9 Fl.	107"	DTC-530-108LorR	4937	DTC-570-108LorR	4366	DTC-560-108LorR	4117	225 lbs.	45
10 Fl.	119"	DTC-530-120LorR	5133	DTC-570-120LorR	4704	DTC-560-120LorR	4418	250 lbs.	50
12 Fl.	143"	DTC-530-144LorR	5643	DTC-570-144LorR	5151	DTC-560-144LorR	4852	270 lbs.	60



NSF
Optional Undershelf



LEFT CLEAN TABLE

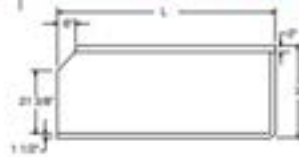

RIGHT CLEAN TABLE

CORNER CLEAN DISHTABLES

Spec-Line K30 Series Standard K70 Series Super Saver K60 Series
 14 Ga. 16 Ga. 16 Ga. w/ Galvanized Legs

Nominal Size	Length	Model #	Price	Model #	Price	Model #	Price	Approx. Weight	Approx. Cu. Ft.
4 Fl.	47"	DTC-K30-48LorR	\$6559	DTC-K70-48LorR	\$6097	DTC-K60-48LorR	\$5721	105 lbs.	29
5 Fl.	59"	DTC-K30-60LorR	6744	DTC-K70-60LorR	6265	DTC-K60-60LorR	5871	115 lbs.	37
6 Fl.	71"	DTC-K30-72LorR	7033	DTC-K70-72LorR	6723	DTC-K60-72LorR	6133	125 lbs.	44
7 Fl.	83"	DTC-K30-84LorR	7366	DTC-K70-84LorR	6982	DTC-K60-84LorR	6397	138 lbs.	51
8 Fl.	95"	DTC-K30-96LorR	7444	DTC-K70-96LorR	7068	DTC-K60-96LorR	6476	157 lbs.	58
9 Fl.	107"	DTC-K30-108LorR	9228	DTC-K70-108LorR	8731	DTC-K60-108LorR	8231	330 lbs.	83
10 Fl.	119"	DTC-K30-120LorR	9669	DTC-K70-120LorR	9133	DTC-K60-120LorR	8544	360 lbs.	92
12 Fl.	143"	DTC-K30-144LorR	10635	DTC-K70-144LorR	9987	DTC-K60-144LorR	9401	380 lbs.	110



NSF



LEFT CORNER CLEAN TABLE



RIGHT CORNER CLEAN TABLE

ATTENTION:
See Dish Machine Information on Pg. 83 to ensure proper compatibility

DISHTABLES

Clean Dishtables

ISLAND CLEAN DISHTABLES

Spec-Line G30 Series Standard G70 Series Super Saver G60 Series
 14 Ga. 16 Ga. 16 Ga. w/ Galvanized Legs

Nominal Size	Length	Model #	Price	Model #	Price	Model #	Price	Approx. Weight	Approx. Cu. Ft.
4 Ft.	47"	DTC-G30-48LorR	\$6373	DTC-G70-48LorR	\$5750	DTC-G60-48LorR	\$5531	102 lbs.	29
5 Ft.	59"	DTC-G30-60LorR	6562	DTC-G70-60LorR	5993	DTC-G60-60LorR	5688	112 lbs.	37
6 Ft.	71"	DTC-G30-72LorR	6850	DTC-G70-72LorR	6136	DTC-G60-72LorR	5942	125 lbs.	44
7 Ft.	83"	DTC-G30-84LorR	7172	DTC-G70-84LorR	6410	DTC-G60-84LorR	6207	135 lbs.	51
8 Ft.	95"	DTC-G30-96LorR	7255	DTC-G70-96LorR	6500	DTC-G60-96LorR	6285	148 lbs.	58
9 Ft.	107"	DTC-G30-108LorR	8980	DTC-G70-108LorR	8001	DTC-G60-108LorR	7734	310 lbs.	83
10 Ft.	119"	DTC-G30-120LorR	9297	DTC-G70-120LorR	8560	DTC-G60-120LorR	8171	340 lbs.	92
12 Ft.	143"	DTC-G30-144LorR	10227	DTC-G70-144LorR	9588	DTC-G60-144LorR	9000	360 lbs.	110

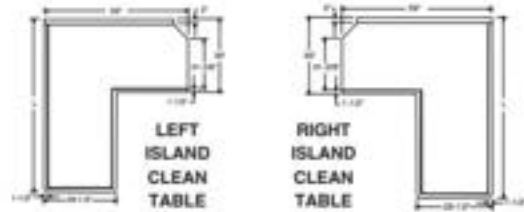

U-SHAPED SOIL DISHTABLES

Nominal Size	Length	Model #	Price	Approx. Weight	Approx. Cu. Ft.
6 Ft.	71"	DTS-U30-72LorR	\$16491	450 lbs.	99
7 Ft.	83"	DTS-U30-84LorR	16809	470 lbs.	114
8 Ft.	95"	DTS-U30-96LorR*	17454	490 lbs.	130
9 Ft.	107"	DTS-U30-108LorR*	17904	525 lbs.	145
10 Ft.	119"	DTS-U30-120LorR*	18358	550 lbs.	160
11 Ft.	131"	DTS-U30-132LorR*	18648	575 lbs.	176
12 Ft.	143"	DTS-U30-144LorR*	18966	600 lbs.	192

*Includes Field Joint (To be welded in field by others)

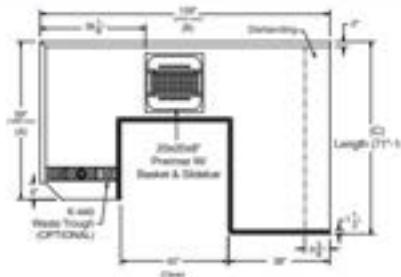

- Includes Pre-rinse sink basket and bar slide and dishlandng.
- Additional length on any leg of dishtables, use DTA-56 \$301 per ft. (Field joint may be required)
- Additional custom lengths available on all sides.
- If any 2 sides are larger than 90°, a welded field joint is required (WELDED BY OTHERS). USE K-57 \$391.
- For additional accessories and modifications, see pages 88-90. Dishlandng may be replaced with backsplash or rolled edge at no additional charge.



Pre-rinse Basket with Welded Slide Bar All Stainless Steel Type 304 Series Perforated Basket for 3/4" Radius Bowls		Model # DTA-100	Size 19 1/2" x 19 1/2"	Price \$905		4" Depth
Pre-rinse Slide Bar		Model # DTA-60	Size 19 1/2" x 19 1/2"	Price \$520		9 lbs. 1 Cu. Ft.

DISHTABLES

Specialty Dishtables

Faucets Can Be Found
On Page 90

ATTENTION:
See Dish Machine Information on
Pg. 83 to ensure proper compatibility

DISHTABLE WITH 3 COMPARTMENT BOWLS



Multiple Bowl Choices & Lengths

• 16 Gauge Stainless Steel • Stainless Steel Legs and Cross Rails • Stainless Steel Bullet Feet



DTC93-2020-8Fl Shown

DEEP DRAWN BOWLS

Model #	Price	Length	Bowl Size	Drainboard Size	Approx. Weight
DTC93-1620-6LorR	\$8224	72"	16" x 20" x 12"	4"	200 lbs.
DTC93-1620-7LorR	8562	84"	16" x 20" x 12"	16"	220 lbs.
DTC93-1620-8LorR	8840	96"	16" x 20" x 12"	28"	240 lbs.
DTC93-1620-9LorR	9295	108"	16" x 20" x 12"	40"	275 lbs.
DTC93-2020-8LorR	9230	96"	20" x 20" x 12"	16"	260 lbs.
DTC93-2020-9LorR	9683	108"	20" x 20" x 12"	28"	310 lbs.
DTC93-2020-10LorR	9996	120"	20" x 20" x 12"	40"	310 lbs.

BOWLS ARE LOCATED 12" IN FROM MACHINE

For Other Configurations, Contact Factory

(Must Verify Machine For Control Box Or Drive Unit Interference)



DTC-3-1620-84L Shown

FABRICATED BOWLS

Model #	Price	Length	Bowl Size	Drainboard Size	Approx. Weight
DTC-3-1620-66LorR	\$8939	66"	16" x 20" x 14"	12"	200 lbs.
DTC-3-1620-84LorR	9306	80"	16" x 20" x 14"	23"	220 lbs.
DTC-3-1620-96LorR	9609	96"	16" x 20" x 14"	35"	240 lbs.
DTC-3-1620-120LorR	10869	119"	16" x 20" x 14"	59"	265 lbs.
DTC-3-1620-144LorR	11380	143"	16" x 20" x 14"	83"	290 lbs.
DTC-3-1824-144LorR	11882	143"	18" x 24" x 14"	77"	365 lbs.
DTC-3-2020-96LorR	10031	96"	20" x 20" x 14"	23"	260 lbs.
DTC-3-2020-108LorR	10525	107"	20" x 20" x 14"	35"	285 lbs.
DTC-3-2020-120LorR	10864	119"	20" x 20" x 14"	48"	310 lbs.
DTC-3-2020-144LorR	11803	143"	20" x 20" x 14"	71"	340 lbs.
DTC-3-2424-144LorR*	12322	143"	24" x 24" x 14"	59"	380 lbs.

* Requires Two Faucets

For Upgrade To 14 Gauge Use **DTA-49** \$862

PRERINSE BASKETS & WELDED SLIDE BARS

Prerinse Baskets with Slide Bar

Model #	Fits Bowls	Price	Wt.	Cu.
DTA-125	16" x 20" x 4"	\$790	9 lbs.	1
DTA-100	20" x 20" x 4"	905	12 lbs.	1
Large Size Baskets				
DTA-58	18" x 24" x 4"	1154	11 lbs.	1
DTA-59	24" x 24" x 4"	1315	20 lbs.	1



DTA-100 Shown

Prerinse Slide Bars

Model #	Fits Bowls	Price	Wt.	Cu.
DTA-64	16" x 20"	\$448	7 lbs.	1
DTA-60	20" x 20"	520	9 lbs.	1
Large Size Prerinse Slide Bars				
DTA-51	18" x 24"	655	8 lbs.	1
DTA-52	24" x 24"	778	10 lbs.	1



Prerinse Baskets & Slide Bar For Deep Drawn Bowls, See Page 87

UNDERCOUNTER DISHTABLE

20" x 20" x 5"
Sink Bowl

Length	Model #	Price	Approx. Weight	Approx. Cu. Ft.
48"	DTU-U60-48LorR	\$4008	80 lbs.	17
60"	DTU-U60-60LorR	4221	95 lbs.	19
72"	DTU-U60-72LorR	4390	115 lbs.	23

Left Or Right Designation Is Determined By Sink Location.



DTU-U60-48R Shown



STAINLESS STEEL CONDENSATE HOODS



8" x 10" vent opening.
Collar is centered 2" in height.

Model #	Length	Width	Height	Price
CH-3636	36"	36"	20"	\$6054
CH-4242	42"	42"	20"	6519
CH-4848	48"	48"	20"	7216
CH-61	Specify Alternate Collar Location			254
CH-56	Additional Length Or Width			741 /lin. Ft.

This Item Is Not UL Or NFPA Listed.

VENT RISER

- Type 300 Stainless Steel
- Adjustable Ceiling Trim Collar
- Accommodates Standard 4" x 16" Vent Hood Duct

(Custom Sizes Available - Consult Factory)



View of Opening

Model #	Length	Width	Height	Price
VR-1	16"	4"	60"	\$2888

This Item Is Not UL Or NFPA Listed.



DISHTABLE MODS

Dishtable Modifications & Accessories



DTA-95



DTA-87



DTA-82



DTA-45



MODIFICATIONS

K-23	Dishtable Legs Welded To Undershelf Or Left-To-Right Cross Rails, Shipped Set Up & Crated. (Top Is Not Welded To Legs)	\$561 /sink
K-23A	Dishtable Legs Welded To Leg Gussets Under Sink Top & To Undershelf Or Left-To-Right Cross Rails, Shipped Set Up & Crated	741 /sink
K-24	Shell Crating	433
K-37	Anti-Siphon Vacuum Breaker Hole	168
K-57	Welded Field Joint (Welded In Place By Others)	391
K-76	Paint On Sound Deadening	746 /sink
K-77	Splash Cut-Out (Pipe Chase)	265
K-440	Waste Trough Installation Welded Into Table And Furnished With A 2" Deep Removable Basket	1277
K-452	Control Bracket 8" x 12"	373 ea.
K-453	Control Bracket 14" x 16"	400 ea.
K-454	Side Splash	581 ea.
K-456	Scrap Block Installed (Includes Rubber Scrap Block)	546 ea.
K-460	Disposal Cone Welded Into Table And Furnished With 8" x 12" Control Bracket & Faucet Holes (Supplied By Others)	1115
K-460A	Installation Of Disposal Cone With 14" x 16" Control Bracket, Faucet Holes (Cone Supplied By Others)	1184
K-461	Disposal Collar Welded Into Sink Bowl And Furnished With 8" x 12" Control Bracket (Supplied By Others)	1115
K-461A	Disposal Collar Welded Into Sink Bowl And Furnished With 14" x 16" Control Bracket (Supplied By Others)	1184
K-472	Special Faucet Hole Location	176 ea.
K-495	Turn Down Backsplash (Incl. 2 Brackets. See K-387 For Add'l Sets)	233
K-508A	Special Modification Charge	355
K-550	Stainless Steel Tubular Rack Storage	279 /in. ft.

DTA-40	Drain Hole (For Sorting Table)	\$191
DTA-45	Scrap Trough Welded To Dump Sink - Min. Scrap Trough Length Is 3'. Max. Length Is 8'. For 20" x 20" x 8" Bowl Spec-Line Soil S30 Series Only. - Consult Factory For Trough Lengths Exceeding 8 Feet	505 /in. ft.
DTA-46	Inside Mitered Corner	751
DTA-66	Provision For Dishloading On Straight Soil Table (Min. 4)	369 /in. Ft.
DTA-70	Install Booster Heater Brackets (Brackets By Others)	237
DTA-72	Provision For Side Loader	1538
DTA-75	Provision For Limit Switch (Limit Switch By Others)	270
DTA-76	Move Pre-Rinse Sink To Conform To Dishmachine Requirements. Please Specify Machine When Placing Order	N/C
DTA-78	Notch In Backsplash Return To Clear Handle Please Specify Machine When Placing Order	204
DTA-81	S/S Welded Leg Assembly with S/S Feet	431 /bowl
DTA-82	15" x 20" x 8" Undercounter Dump Sink	3631 /bowl
DTA-84	Simple Pass-Thru (Specify Wall Thickness - Min. Length 36")	895 /ft.
DTA-87	Pass-Thru Wall Frame (Specify Wall Thickness - Min. Length 36")	512 /in. Ft.
DTA-95	Install Scraper Top	2473
DTA-96	Install Trough Collector	3043
DTA-99A	16" x 20" x 12" Sink Bowls	1912 /bowl
DTA-99B	20" x 20" x 12" Sink Bowls	2054 /bowl
DTA-99C	10" x 14" x 5" Dump Sink	1636 /bowl
DTA-99D	16" x 24" x 14" Sink	2244 /bowl
DTA-99E	24" x 24" x 14" Sink	2390 /bowl
DTA-106	Mirror Highlight To Dishtable Upgrade	590

ACCESSORIES

K-4	Lever Drain Bracket	\$189
K-5	Twist Handle Operated Drain	388
K-15	Twist Handle Operated Drain With Overflow	712
K-397	Wall Brackets (2 Each. Brackets Included With K-485)	119 /set
K-453C	Stainless Steel Sink Cover 16" x 20"	691
K-455E	Stainless Steel Sink Cover 20" x 20"	691
K-457	Replacement Rubber Scrap Block (See K-456 For Install Cost)	166 ea.
K-475	Replacement S/S Leg With Stainless Steel Bullet Foot	100 ea.
K-478	Replacement Stainless Steel Bullet Foot	40 ea.
K-488	Flanged S/S Bullet Foot	85 ea.
K-550	Stainless Steel Tubular Rack Storage	279 /in. Ft.
K-610	Perforated Stainless Steel Sink Grid (Specify Bowl Size)	1066 ea.
K-700D	12" High Removable Side Splash For Dishtables (Specify Model)	674 ea.
DTA-53	SPEC-LINE Heavy Duty Pre-Rinse Faucet	1266
DTA-51	Pre-Rinse Slide Bar for 18" x 24" Fab. Sink Bowls	655

DTA-52	Pre-Rinse Slide Bar for 24" x 24" Fab. Sink Bowls	\$778
DTA-55	Column Notch (Includes Splash)	1066
DTA-56	Add'l Length On 5/8" Side Of Corner Or Straight Tables	301 /in. Ft.
DTA-58	Pre-Rinse Basket w/ Side Bar for 18" x 24" Fab. Sink Bowls	1154
DTA-59	Pre-Rinse Basket w/ Side Bar for 24" x 24" Fab. Sink Bowls	1315
DTA-60	Pre-Rinse Slide Bar for 20" x 20" Fab. Sink Bowls	520
DTA-62	Pre-Rinse Basket For 20" x 20" Deep Drawn Bowls	1135
DTA-63	Pre-Rinse Slide Bar For 20" x 20" Deep Drawn Bowls	520
DTA-64	Pre-Rinse Slide Bar For 18" x 20" Fab. Sink Bowls	448
DTA-65	Pre-Rinse Slide Bar For 16" x 20" Deep Drawn Bowls	448
DTA-67	Stainless Steel Rear Cross-Bracing (Factory Installed Only)	50 /in. Ft.
DTA-69	Pre-Rinse Basket For 16" x 20" Deep Drawn Bowls	1080
DTA-100	Pre-Rinse Basket with Side Bar for 20" x 20" Fab. Sink Bowls	905
DTA-125	Pre-Rinse Basket with Side Bar for 18" x 20" Fab. Sink Bowls	790
DTA-125A	Pre-Rinse Scrap Basket For DTA-82 Undermount Dump Sink	1056

DISHTABLES

Dishtable Faucets & Accessories

= Ships via UPS

**SPEC-LINE
EXTRA HEAVY DUTY
14" Splash Mounted
Swing Spout Faucet**



K-105 \$704
T&S Equivalent Model # B221

**Splash Mounted
Prerinse Faucet**

K-116 \$1758

12" Add-A-Faucet
K-117-TS \$771
(Fits K-116 Only)

Prerinse Faucets

Prerinse Features:

- 8" O.C.
- Wall Bracket
- Continuous Spray Ring
- Heavy Duty Chrome Plated Spring

**SPEC-LINE
HEAVY DUTY
Splash Mounted**

DTA-53 \$1266
T&S Equivalent
Model # B133-B

12" Add-A-Faucet
K-117 \$495
(Fits DTA-53 Only)

**Table Mounted
SORTING SHELVES**

Mounts to backplash and end roll of dishtable (D, G and U-shaped Dishtables only)
Shelf Shipped Separate From Table To Reduce Freight Costs And Chance Of Shipping Damage.



New Versatile Design allows for Different Glass Rack Applications

- Drip Tubes For Water Drainage
- 14 Gauge End Plates
- 18 Gauge, 1 5/8" Tubes

DTA-79 \$671 /lin. Ft.



- Drip Tubes For Water Drainage
- 14 Gauge End Plates & Base
- 18 Gauge, 1 5/8" Tube

DTA-79S \$853 /lin. Ft.

**STAINLESS STEEL
UNDERSHELVES**

**Additional Storage
Shelving is Reversible (Left Or Right)**



Size Undershelf To Be At Least 6" Shorter Than Dishtable.
Now With Stainless Steel Legs!

Length	Model #	Price	Approx. Wt.	Approx. Cubes
18"	DTA-SS-18	\$633	11 lbs.	1
24"	DTA-SS-24	722	13 lbs.	1
30"	DTA-SS-30	762	15 lbs.	1
42"	DTA-SS-42	812	20 lbs.	2
54"	DTA-SS-54	926	23 lbs.	2
66"	DTA-SS-66	1044	30 lbs.	3
78"	DTA-SS-78	1107	35 lbs.	3
90"	DTA-SS-90	1180	39 lbs.	4
102"	DTA-SS-102	1338	45 lbs.	5
114"	DTA-SS-114	1394	50 lbs.	5
126"	DTA-SS-126	1643	55 lbs.	6
138"	DTA-SS-138	1714	59 lbs.	6

SORTING SHELVES

Traditional Design



FOR TABLE MOUNTED, ADD DTA-88 \$851

KD Tubular Design



Length	Model #	Racks	Price	Approx. Wt.	Approx. Cubes
22"	DT-6R-11	1	\$1821	20 lbs.	1
42"	DT-6R-12	2	1948	30 lbs.	2
62"	DT-6R-13	3	2046	40 lbs.	4
82"	DT-6R-14	4	2180	50 lbs.	5

Length	Model #	Racks	Price	Approx. Wt.	Approx. Cubes
22"	DT-6R-21	1	\$1356	15 lbs.	1
42"	DT-6R-22	2	1530	23 lbs.	2
62"	DT-6R-23	3	1631	30 lbs.	4
82"	DT-6R-24	4	1733	38 lbs.	5

SORTING TABLES 16 Gauge 304 Stainless Steel - 3" Raised Edge
STAINLESS STEEL CROSS BRACING ON ALL SIDES

Standard

Model #	Price	Size	Approx. Wt.	Approx. Cubes
SR-48	\$2966	48" x 30"	84 lbs.	12
SR-60	3138	60" x 30"	98 lbs.	15
SR-72	3313	72" x 30"	109 lbs.	18
SR-96	3704	96" x 30"	143 lbs.	21



Shown With Optional Casters

10 1/2" Backsplash

Model #	Price	Size	Approx. Wt.	Approx. Cubes
BSR-48	\$2999	48" x 30"	88 lbs.	12
BSR-60	3161	60" x 30"	103 lbs.	15
BSR-72	3331	72" x 30"	115 lbs.	18
BSR-96	3830	96" x 30"	150 lbs.	21



TA-255 Super Heavy Duty Casters..... \$791
DTA-40 Drain Hole..... 191

WARNING: Faucets on this page may contain a chemical known to the State of California to cause cancer, birth defects or other reproductive harm.

Underbar Basics™

Featuring New Extended Widths!

Sinks, Blender Stations, Drainboards & Liquor Racks now have a new flush design for a clean, linear appearance when adding SRK Speed Rails.



Features and Benefits

- 18", 21", 23" & 26" Widths
- 4" Backsplash
- All Units Come with 4 Galvanized Legs w/ Adjustable Plastic Bullet Feet
- Selected Models Feature Adjustable Galvanized Cross-Bracing (Front to Back)
- Embossed & Seamless Drainboards (Where Applies)
- Blender Stations Include Hidden Duplex Electrical Outlet



For a Full Line of

PRESTIGE
Signature Series

Equipment See Pages 102-119

UNDERBAR DROP-INS



Drop-In Ice Bins, Water Stations & Hand Sinks

DROP-IN WATER STATIONS

Includes K-54 Deck Mount Faucet With "Push-Back" Acrylic Lever Arm



D-24-WSIBL \$1969

Removable Grate Covers Drip Pan
1 1/2" Deep Insulated Ice Bin w/ S/S Steel Cover
1" IPS Drain
Outside Dim.: 21" x 18"
Cut-Out Size: 20 5/8" x 15 1/4"
30 lbs. - 5 cu. Ft.

D-24-WSIBL2 \$2355

Removable Grate Covers Drip Pan
1 1/2" Deep Insulated Ice Bin w/ S/S Steel Cover
1" IPS Drain
Outside Dim.: 18" x 21"
Cut-Out Size: 15 1/4" x 20 5/8"
47 lbs. - 5 cu. Ft.

Add A 7-Circuit Cold Plate
To D-24-WSIBL2
Add SJ-49 \$2584

Underbar Basics™

For Custom Cut-Out Use
Model # TA-34 \$355



DI-1-9 \$1466

Removable Electro-Polished
Stainless Steel Grill
1 1/2" IPS Basket Drain
Cut-Out Size: 11 1/4" x 13 1/4"
15 lbs. - 3 cu. Ft.

DROP-IN BAR HAND SINKS

Featuring Deep Drawn Sink Bowls



DI-1-5 \$825

K-52 Deck Mounted Faucet
1 1/2" IPS Basket Drain
Cut-Out Size: 12 1/4" x 18 1/4"
20 Gauge Stainless Steel
12 lbs. - 2 cu. Ft.



DI-1-25 \$919

K-52 Deck Mounted Faucet
1 1/2" IPS Basket Drain
Cut-Out Size: 11 1/4" x 13 1/4"
20 Gauge Stainless Steel
8 lbs. - 2 cu. Ft.



D-24-SIBL \$2104

K-51 Deck Mounted Faucet
Insulated Ice Bin w/ S/S Cover
1" IPS Drain In Ice Bin
Outside Dim.: 21" x 18"
Cut-Out Size: 20 5/8" x 15 1/4"
Factory Installed Only
20 Gauge Galvanized Steel
30 lbs. - 5 cu. Ft.

For Our Full Line Of Drop-in Sinks, See pages 3-5

ACCESSORIES & MODIFICATIONS

Replacement Sliding Stainless Steel Covers

Model #	Price	For Use With:
D-12	\$134	D-12-IBL, D-24-WSIBL, D-24-WSIBL2, D-24-SIBL
D-24	153	D-24-IBL, D-24-IBL-7
D-24V	173	D-24-IBL, D-24-IBL-7
D-30	218	D-30-IBL, D-30-IBL-7
D-36	248	D-36-IBL, D-36-IBL-7



Cover designed to open front-to-rear, with 18" ice bin dimension front-to-rear.
(D-24-WSIBL2 opens left to right when installed with 21" front-to-rear)



Add Wrist Handles
K-316-LU
\$167

Water Filler Faucets

K-54 8-1/4" High \$744
K-54A 12" High \$845
K-54OMIT -\$420
Omit K-54 Faucet



6" Deck Mounted Faucet
K-51 \$663
4" O.C.



3 1/2" Gooseneck Deck Mounted Faucet
K-52 \$331



UNDERBAR DROP-INS

Drop-In Ice Bins, Bar Sinks & Drain Pans

Underbar Basics™

DROP-IN ICE BINS

11" Deep Insulated Ice Bin w/ Sliding Stainless Steel Cover

- Rubber Thermal Breaker Reduces Condensation
- Optional 7-Circuit Cold Plate Sealed Into The Bottom

Model #	Price	Overall Length	Cut Out Size W x L	Ice Capacity	Approx. Weight	Approx. Cu. Ft.
D-12-IBL	51579	12"	15 1/4" x 9 5/8"	23 lbs.	22 lbs.	3
D-24-IBL	1731	21"	15 1/4" x 20 3/8"	50 lbs.	39 lbs.	5
D-30-IBL	1752	27"	15 1/4" x 26 3/8"	62 lbs.	62 lbs.	8
D-36-IBL	1957	33"	15 1/4" x 32 3/8"	75 lbs.	67 lbs.	9
w/ 7-CIRCUIT COLD PLATE						
D-24-IBL-7	3941	21"	15 1/4" x 20 3/8"	50 lbs.	84 lbs.	9
D-30-IBL-7	3991	27"	15 1/4" x 26 3/8"	62 lbs.	107 lbs.	13
D-36-IBL-7	4178	33"	15 1/4" x 32 3/8"	75 lbs.	113 lbs.	15



Includes Sliding Stainless Steel Cover

For Replacement Sliding Stainless Steel Covers, See Page 92.

DROP-IN BAR SINKS

Optional Built-in Embossed Drainboard

- 10" x 14" x 10" Sink Bowls
- 9" High Overflow Pipe(s) w/ 1 1/2" IPS Drain(s)
- 4" O.C. Deck Mounted Swing Faucet
- 4" O.C. Deck Mounted Faucet

Model #	Price	# of Bowls	# of Drbd.	Drbd. Size	Drbd. Location	Outside Dim. W x L	Cut Out Size W x L	Approx. Weight	Approx. Cu. Ft.
DBS-1	51208	1	0	N/A	N/A	12" x 19"	12 1/4" x 18 1/4"	21 lbs.	3
DBS-2	1355	2	0	N/A	N/A	25 1/2" x 19"	24 3/4" x 18 1/4"	26 lbs.	4
DBS-3	1631	3	0	N/A	N/A	38" x 19"	37 1/4" x 18 1/4"	42 lbs.	9
DBS-43L	2457	3	1	12"	Right	21 1/8" x 48 5/16"	17" x 47"	88 lbs.	10
DBS-43R	2457	3	1	12"	Left	21 1/8" x 48 5/16"	17" x 47"	88 lbs.	10
DBS-53C	2675	3	2	12"	Left & Right	21 1/8" x 60 5/16"	17" x 59"	100 lbs.	21
DBS-63C	2793	3	2	18"	Left & Right	21 1/8" x 72 5/16"	17" x 71"	110 lbs.	24

L and R Indicate Sink Location, C Indicates Sink is Centered.



18" WIDE COUNTERTOP DRAIN PAN

- Removable Drip Tray
- Stainless Steel Top
- 1/2" NPT Drain

CUSTOM SIZES AVAILABLE
Consult Factory For Details



Model #	Price	Size W x L	Cut Out Size	Approx. Weight	Approx. Cu. Ft.
DP-1818	51113	18" x 18"	15 3/4" x 15 3/4"	18 lbs.	2
DP-1824	1137	18" x 24"	15 3/4" x 21 3/4"	23 lbs.	2
DP-1830	1162	18" x 30"	15 3/4" x 27 3/4"	28 lbs.	3
DP-1836	1202	18" x 36"	15 3/4" x 33 3/4"	33 lbs.	3
DP-1842	1293	18" x 42"	15 3/4" x 39 3/4"	38 lbs.	4
DP-1848	1394	18" x 48"	15 3/4" x 45 3/4"	43 lbs.	4

BAR DRINK RAILS

- Type 300 Stainless Steel
- 8" Wide (Front To Back) x 3/4" Deep
- Perforated Removable Grate Allows For Easy Cleaning
- 1" Drain On Right Side
- Designed To Secure To Underside Of Wood Substrate



Model #	Price	Size W x L	Approx. Weight	Approx. Cu. Ft.
DRKR-12	5404	8" x 12"	10 lbs.	2
DRKR-18	449	8" x 18"	15 lbs.	2
DRKR-24	473	8" x 24"	20 lbs.	2
DRKR-30	543	8" x 30"	25 lbs.	2
DRKR-36	602	8" x 36"	30 lbs.	3
DRKR-42	682	8" x 42"	35 lbs.	3
DRKR-48	767	8" x 48"	40 lbs.	3

OPTIONS

- DRKC-45-IC
45" Inside Corner
 - DRKC-45-OC
45" Outside Corner
 - DRKC-90-IC
90" Inside Corner
 - DRKC-90-OC
90" Outside Corner
- \$752 ea.**

COUNTERTOP GLASS RINSER

Rinses away any impurities that might be in the glass!

- Mounts Easily to countertop or bar equipment
- Brushed Stainless Steel
- Water Rinsers And Glass Actuator By Pushing Down On Glass
- Threaded Drain For 1/2" Drain Hose

FACTORY INSTALLED ONLY



Model #	Price	Size	Approx. Wt	Approx. Cu. Ft.
SU-16	5993	6 3/8" x 6 3/8" x 3/4"	7 lbs.	1

GLASS RINSER FOR PERFORATED DRAINBOARDS (Activator Only)

FACTORY INSTALLED ONLY

SU-16P	5993	4 1/4" Diameter	3 lbs.	1
--------	------	-----------------	--------	---



UNDERCOUNTER GLASS RINSER

Rinses away any impurities that might be in the glass!

- Mounts Easily to Underside Of Wood Substrate
- Brushed Stainless Steel
- Retrofit any liquid dispense station
- Water Rinsers And Glass Actuator By Pushing Down On Glass
- Threaded Drain For 1/2" Drain Hose



Model #	Price	O.A. W x L x H	Rinsers Size W x L x H	Approx. Wt	Approx. Cu. Ft.
SU-16UM	51316	6 3/8" x 11 3/8" x 1"	6-3/8" x 6-3/8" x 1"	8 lbs.	1

WARNING: Faucets on this page may expose you to chemicals, including lead, that are known to the State of California to cause cancer or birth defects or other reproductive harm. For more info, visit www.p66warnings.ca.gov

BAR HAND SINKS

Free Standing Bar Hand/Dump Sinks

Underbar **BASICS**

BAR HAND SINKS



Bowl Size: 10" x 14" x 10" • 29" Working Height • 4" High Backsplash
Includes 1-1/2" IPS Drain & Galvanized Legs w/ Adjustable Galvanized Side Cross-Bracing & Adjustable Plastic Bullet Feet
Add SU-10A For Stainless Steel Leg & Stainless Steel Bullet Foot Upgrade w/ Front-to-Back Cross-Bracing **\$360**



18" Wide Units

- 4" O.C. Splash Mounted Swing Spout Faucet

Model #	Price	Overall Length	Approx. Weight	Approx. Cu. Ft.
SL-HS-12	\$1337	12"	31 lbs.	5
SL-HS-15	1419	15"	34 lbs.	6



21" Wide Units

- 4" O.C. Deck Mounted Swing Spout Faucet
- Rear Deck For Extra Storage

Model #	Price	Overall Length	Approx. Weight	Approx. Cu. Ft.
CR-HS-12	\$1385	12"	32 lbs.	6
CR-HS-15	1458	15"	35 lbs.	6

HAND SINKS W/ BUILT-IN SOAP & TOWEL DISPENSERS

Bowl & Faucet • 29" Working Height • 4" High Backsplash
Includes 1 1/2" IPS Basket Drain & Galvanized Legs w/ Adjustable Galvanized Side Cross-Bracing & Adjustable Plastic Bullet Feet
Add SU-10C For Stainless Steel Leg & Stainless Steel Bullet Foot Upgrade w/ Front-to-Back Cross-Bracing **\$360**



21" Wide Standard Units

- 4" O.C. Deck Mounted Swing Spout Faucet
- Rear Deck For Extra Storage

Model #	Price	Overall Length	Approx. Weight	Approx. Cu. Ft.
SC-12-TS	\$1733	12"	45 lbs.	4
SC-15-TS	1777	15"	49 lbs.	4



21" Wide Side Splash Units

- 4" O.C. Deck Mounted Swing Spout Faucet
- 4" High Stainless Steel Side Splashes
- Rear Deck For Extra Storage

Model #	Price	Overall Length	Approx. Weight	Approx. Cu. Ft.
SC-12-TS-S	\$2169	12"	50 lbs.	4
SC-15-TS-S	2219	15"	54 lbs.	4

18" Wide Units Available - Consult Factory

HAND SINK ACCESSORIES & MODIFICATIONS



Add Wrist Handles
K-316-LU **\$167**
For Deck & Splash Mount Faucets



Replacement Deck Mount Soap Dispenser
K-12 **\$211**



Chrome Towel Ring
A-15 **\$136** Packed Loose



Replacement 6" Splash Mount Faucet
K-125 **\$432**
4" O.C. 6" Spout



Add A Side Splash
SU-18R or L **\$229**
SU-18RL **\$463**
For 21" Wide Units
SU-21R or L **\$250**
SU-21RL **\$495**



Stainless Steel Leg Upgrade
• Includes 2 Sets of (2) S/S Legs w/ Adjustable S/S Bullet Feet & Adjustable S/S Front-to-Back Cross-Bracing
• Leg Heights Do Not Include 1 1/4" Bullet Foot Height
SU-10A **\$360** 18" Legs
SU-10C **\$360** 14" Legs

For Our Full Line Of Modifications & Accessories, See Page 118-120.

Underbar **BASICS™**

BAR SINKS

Bar Sinks

BAR SINKS

w/ 10" x 14" x 10"

- 4" High Backsplash
- 29" working Height
- Molded Apron For Extra Durability
- Each Sink Bowl Includes an Overflow Pipe w/ 1 1/2" IPS Drain
- Galvanized Legs w/ Adjustable Galvanized Side Cross-Bracing & Adjustable Plastic Bullet Feet

- **SLB Series** Includes 1 - 4" O.C. Splash Mounted Swing Spout Faucet
- **CRB Series** Includes 1 - 4" O.C. Deck Mounted Swing Spout Faucet & Has Rear Deck For Extra Storage
- **4 Comp. Sinks** Include Two 6" Swing Spout Faucets



SLB Series
18" Wide Units With
Splash Mount Faucet



CRB Series
21" Wide Units With
Deck Mount Faucet



L And R Indicate Sink Location. C Indicates Sink Is Centered.

	SPLASH MOUNT FAUCET				DECK MOUNT FAUCET				O.A. Length	# of Drbds.	Drbd. Length	Approx. Cu. Ft.
	18" WIDE	Price	Spout Size	Approx. Wt.	21" WIDE	Price	Spout Size	Approx. Wt.				
1 COMP.	SLB-31C	\$2031	6"	55 lbs.	CRB-31C	\$2239	6"	55 lbs.	36"	2	12"	13
	SLB-22C	2145	6"	54 lbs.	CRB-22C	2309	6"	54 lbs.	24"	0	N/A	8
2 COMP.	SLB-32LorR	2277	6"	57 lbs.	CRB-32LorR	2429	6"	57 lbs.	36"	1	9"	13
	SLB-42LorR	2333	6"	62 lbs.	CRB-42LorR	2500	6"	62 lbs.	48"	1	21"	15
3 COMP.	SLB-42C	2333	6"	66 lbs.	CRB-42C	2520	6"	66 lbs.	48"	2	12"	15
	SLB-33C	2460	10"	65 lbs.	CRB-33C	2628	12"	65 lbs.	36"	0	N/A	13
	SLB-43LorR	2586	10"	66 lbs.	CRB-43LorR	2767	12"	66 lbs.	48"	1	9"	15
	SLB-53C	2721	10"	76 lbs.	CRB-53C	2913	12"	76 lbs.	60"	2	12"	18
4 COMP.	SLB-63C	2869	10"	88 lbs.	CRB-63C	3070	12"	88 lbs.	72"	2	18"	22
	SLB-73C	3190	10"	162 lbs.	CRB-73C	3413	12"	170 lbs.	84"	2	24"	39
	SLB-83C	3486	10"	183 lbs.	CRB-83C	3741	12"	191 lbs.	96"	2	30"	44
4 COMP.	SLB-64C*	3387	6"	92 lbs.	CRB-64C*	3608	6"	92 lbs.	72"	2	12"	22
	SLB-74C*	3603	6"	164 lbs.	CRB-74C*	3853	6"	172 lbs.	84"	2	18"	39
	SLB-84C*	3915	6"	185 lbs.	CRB-84C*	4169	6"	193 lbs.	96"	2	24"	44

*4 Comp. Bar Sinks Include 2 - 6" Swing Spout Faucets

BAR SINK & ICE BIN COMBO

With Removable Plastic Bottle Racks

- 4" Backsplash
- 29" Working Height
- Three or Four Compartment - 10" x 14" Bowls
- Each Sink Bowl Includes Overflow Pipe & 1-1/2" I.P.S. Drain
- Molded Apron For Extra Durability
- 24" x 15" x 8" Insulated Ice Bin; 54 lbs. Ice Capacity
- Ice Bin Includes 1" IPS Drain
- Galvanized Legs w/ Adjustable Galvanized Side Cross-Bracing & Adjustable Plastic Bullet Feet
- **SLC Series** Includes 1 - 4" O.C., 10" Splash Mounted Swing Spout Faucet
- **CRC Series** Includes 1 - 4" O.C., 12" Deck Mounted Swing Spout Faucet & Has Rear Deck For Extra Storage



SLC-83C-R

Add A 7-Circuit Cold Plate
To SLC or CRC series
Add SU-49 \$2584

L And R Indicates Ice Bin Location.

SPLASH MOUNT FAUCET		DECK MOUNT FAUCET		O.A. Length	# of Bowls	# of Drbds.	Drbd. Length	Approx. Weight	Approx. Cu. Ft.
18" WIDE	Price	21" WIDE	Price						
SLC-73C-LorR	\$3682	CRC-73C-LorR	\$3935	84"	3	2	12"	185 lbs.	26
SLC-83C-LorR	3817	CRC-83C-LorR	4070	96"	3	2	18"	225 lbs.	32
SLC-84C-LorR*	4274	CRC-84C-LorR*	4557	96"	4	2	12"	225 lbs.	32

*4 Comp. Bar Sinks Include 2 - 6" Swing Spout Faucets

BAR SINK MODIFICATIONS

Add A Side Splash

For 18" Wide Units
SU-18R or L **\$229**
SU-18RL **\$463**

For 21" Wide Units
SU-21R or L **\$250**
SU-21RL **\$495**

Stainless Steel Leg Upgrade

- Includes 2 Sets of (2) S/S Legs w/ Adj. S/S Bullet Feet & Adj. S/S Front-to-Back Cross-Bracing
- Leg Heights Do Not Include 1 1/4" Bullet Foot Ht.

SU-10A **\$360**
18" Legs

For Our Full Line Of Speed Rails, See Page 101.

WARNING: Equipment that includes a faucet may expose you to chemicals, including lead, that are known to the State of California to cause cancer or birth defects or other reproductive harm. For more info, visit www.p66warnings.ca.gov.

ICE BINS

Ice Bins

All Bottle Racks Must Be Removed For NSF Compliance & For Use With Optional Cover

Underbar Basics™

Quick Pour Bottles Not Included

12" or 16" Deep Insulated Ice Bins • 29" Working Height

- 4" Backsplash
- Includes Two Removable Plastic Bottle Racks
- Galvanized Legs w/ Adjustable Galvanized Side Cross-Bracing & Adjustable Plastic Bullet Feet
- CRI Series Has Rear Deck For Extra Storage
- Optional 7 or 10 Circuit Cold Plate Sealed Into The Bottom



Ice Bin Depth	O.A.	Ice Bin Capacity	18" WIDE	Price	Approx. Wt.	21" WIDE	Price	Approx. Wt.	Approx. Cu. Ft.
12" DEEP	12"	35 lbs.	SLI-12-12	\$1462	46 lbs.	CRI-12-12	\$1484	50 lbs.	6
	24"	77 lbs.	SLI-12-24	1715	60 lbs.	CRI-12-24	1829	65 lbs.	8
	30"	98 lbs.	SLI-12-30	1895	68 lbs.	CRI-12-30	2079	72 lbs.	11
	36"	119 lbs.	SLI-12-36	2071	78 lbs.	CRI-12-36	2220	80 lbs.	12
	42"	140 lbs.	SLI-12-42	2167	84 lbs.	CRI-12-42	2311	90 lbs.	13
16" DEEP	48"	161 lbs.	SLI-12-48	2264	90 lbs.	CRI-12-48	2412	98 lbs.	14
	24"	100 lbs.	SLI-16-24	2196	69 lbs.	CRI-16-24	2361	72 lbs.	8
	30"	127 lbs.	SLI-16-30	2445	78 lbs.	CRI-16-30	2625	82 lbs.	12
36"	155 lbs.	SLI-16-36	2695	88 lbs.	CRI-16-36	2888	90 lbs.	17	
w/ 7-CIRCUIT COLD PLATE									
12" DEEP	24"	77 lbs.	SLI-12-24-7	3515	119 lbs.	CRI-12-24-7	3631	122 lbs.	8
	30"	128 lbs.	SLI-12-30-7	3697	133 lbs.	CRI-12-30-7	3826	136 lbs.	11
	36"	149 lbs.	SLI-12-36-7	3871	144 lbs.	CRI-12-36-7	4019	147 lbs.	13
	42"	170 lbs.	SLI-12-42-7	3966	157 lbs.	CRI-12-42-7	4110	163 lbs.	13
	48"	191 lbs.	SLI-12-48-7	4065	169 lbs.	CRI-12-48-7	4123	175 lbs.	14
16" DEEP	24"	100 lbs.	SLI-16-24-7	3993	128 lbs.	CRI-16-24-7	4159	138 lbs.	8
	30"	127 lbs.	SLI-16-30-7	4241	140 lbs.	CRI-16-30-7	4428	143 lbs.	12
	36"	155 lbs.	SLI-16-36-7	4499	153 lbs.	CRI-16-36-7	4690	59 lbs.	17
w/ 10-CIRCUIT COLD PLATE									
12" DEEP	30"	98 lbs.	SLI-12-30-10	5300	165 lbs.	CRI-12-30-10	4794	69 lbs.	11
	36"	119 lbs.	SLI-12-36-10	5696	177 lbs.	CRI-12-36-10	4927	181 lbs.	12
	42"	140 lbs.	SLI-12-42-10	4924	188 lbs.	CRI-12-42-10	5171	191 lbs.	13
	48"	161 lbs.	SLI-12-48-10	5133	201 lbs.	CRI-12-48-10	5357	208 lbs.	14
16" DEEP	30"	127 lbs.	SLI-16-30-10	5300	174 lbs.	CRI-16-30-10	5712	180 lbs.	12
	36"	155 lbs.	SLI-16-36-10	5696	185 lbs.	CRI-16-36-10	6049	192 lbs.	17

INSULATED BOTTLE STORAGE BIN

Featuring 12" Deep Insulated Ice Bin

Quick Pour Bottles Not Included

- 4" Backsplash
- 29" working height
- Includes Two 3-Pack Plastic Bottle Racks
- Galvanized Legs w/ Adjustable Galvanized Side Cross-Bracing & Adjustable Plastic Bullet Feet
- 1" I.P.S. Drain

18" WIDE			21" WIDE		
Model #	Price	Approx. Weight	Model #	Price	Approx. Weight
SLI-12-12	\$1462	46 lbs.	CRI-12-12	\$1484	50 lbs.



PORTABLE ICE BIN 16" Extra Deep For Beer Bottle Storage

- Insulated Ice Bin
- 29" working height
- Stainless Steel Welded Cross-Braced Legs w/ Casters (2 w/ Brakes)
- 1" IPS Drain w/ Shut Off Valve

Model #	Price	Size L x W x H	Ice Bin Capacity	Approx. Weight	Approx. Cu. Ft.
SCI-MIC-24	\$1986	24" x 18 3/4" x 29"	100 lbs.	120 lbs.	7
SCI-MIC-30	2072	30" x 18 3/4" x 29"	127 lbs.	130 lbs.	12
SCI-MIC-36	2225	36" x 18 3/4" x 29"	155 lbs.	145 lbs.	16

18 3/4" WIDE



ICE BIN ACCESSORIES & MODIFICATIONS

Sliding Stainless Steel Covers For Ice Bins

For SLI & CRI Series

SSC-12	For 12" Ice Bin	\$240
SSC-24	For 24" Ice Bin	268
SSC-30	For 30" Ice Bin	297
SSC-36	For 36" Ice Bin	318
SSC-42	For 42" Ice Bin	363
SSC-48	For 48" Ice Bin	374



For Older Style Ice Bins Prior to 2015

SSC-23	For 24" Ice Bin	\$311
SSC-29	For 30" Ice Bin	325
SSC-35	For 36" Ice Bin	345

Stainless Steel Leg Upgrade

Includes 2 Sets of (2) S/S Legs w/ Adj. S/S Bullet Feet & Adj. S/S Front-to-Back Cross-Bracing

SU-10B	10" legs (16" Deep Ice Bins)	\$347
SU-10C	14" legs (12" Deep Ice Bins) Leg Heights Do Not Include 1 1/4" Bullet Foot Height	360

Stainless Steel Ice Bin Partitions

A-38	8" High x 14 3/4" Wide Partition	174
A-39	12" High x 14 3/4" Wide Partition	174
A-40	18" High x 14 3/4" Wide Partition	174
SU-24	Provision To Connect Underbar Equipment (Price Per Every 2 Units)	199
SU-30	Soda Chase Provision (Top-Out) (Only For Ice Bins w/Backsplash)	637

Underbar **Basics**

BAR DRAINBOARDS

Standard & Specialty Bar Drainboards

NSF All Drainboards Are NSF Approved



SLD-3

- Embossed & Seamless Drainboard
- 4" Backplash
- Galvanized Legs w/ Adjustable Galvanized Side Cross-Bracing & Adjustable Plastic Bullet Feet
- 1" IPS Drain
- CRD Series Has Rear Deck For Extra Storage

FREE-STANDING BAR DRAINBOARDS

29" Working Height

Overall Length	18" WIDE			21" WIDE				
	Model #	Price	Approx. Weight	Approx. Cu. Ft.	Model #	Price	Approx. Weight	Approx. Cu. Ft.
12"	SLD-12	\$927	26 lbs.	7	CRD-12	\$1035	28 lbs.	8
18"	SLD-18	1020	29 lbs.	7	CRD-18	1167	30 lbs.	8
24"	SLD-2	1191	35 lbs.	7	CRD-2	1267	39 lbs.	8
30"	SLD-30	1263	40 lbs.	10	CRD-30	1436	41 lbs.	12
36"	SLD-3	1384	42 lbs.	10	CRD-3	1520	47 lbs.	12
48"	SLD-4	1640	55 lbs.	12	CRD-4	1767	51 lbs.	16

Add SU-40 To Prep Unit For Speed Rail Installation - \$116

MAKE 24" CORNER DRAINBOARDS
Add to SLD-2 or CRD-2 Drainboards Only

Model #	Price	W x L
SU-1824R or L	\$300	18" x 24"
SU-2124R or L	334	21" x 24"

RECESSED BAR DRAINBOARDS

Holds Multiple Tiers Of Glasses • 23 1/2" Working Height



SL-GS-12 Shown
23" Wide Units



CR-GS-18 shown
26" Wide Units

- Includes Four Galvanized Legs w/ Adjustable Galvanized Side Cross-Bracing & Adjustable Plastic Bullet Feet
- Embossed And Seamless Drainboard
- 1" IPS Drain Centered In Drainboard
- CR-GS Series Has Rear Deck For Extra Storage

Overall Length	23" WIDE			26" WIDE				
	Model #	Price	Approx. Weight	Approx. Cu. Ft.	Model #	Price	Approx. Weight	Approx. Cu. Ft.
12"	SL-GS-12	\$864	20 lbs.	6	CR-GS-12	\$982	20 lbs.	6
15"	SL-GS-15	912	22 lbs.	6	CR-GS-15	1002	22 lbs.	6
18"	SL-GS-18	993	24 lbs.	7	CR-GS-18	1076	24 lbs.	8
24"	SL-GS-24	1109	28 lbs.	7	CR-GS-24	1229	28 lbs.	8

FROZEN DRINK MACHINE STANDS

10-1/2" Working Height



SCFD-18



Creased surface to allow liquids to flow towards rear center drain

- 14" Backplash
- Features A Lower Working Height To Accommodate The Height Of Most Drink Machines For Underbar Use
- Beveled Front
- Drain Centered In Back Of Unit
- Galvanized Legs w/ Adjustable Plastic Bullet Feet
- Adjustable Galvanized Side Cross-Bracing

SCFD-18 \$1441
18" x 28" x 33"
Holds One Drink Machine
45 lbs. 10 Cu. Ft.

BLENDER STATIONS

Blender Stations & Uni-Serv Speed Bar

Underbar **Basics**SM

BLENDER STATIONS

Includes Four Galvanized Legs w/ Adjustable Plastic Bullet Feet
Featuring Adjustable Galvanized Side Cross-Bracing
All Faucets Meet Federal Lead Free Standards



All Blender Stations Include A
15A - 120V GFI Duplex Receptacle
Hidden Beneath Blender Shelf



WANT US TO CONNECT IT?
Add SU-24

Price Per Every Two Units **\$199**



SL-RS Series
23" Wide Units With
Splash Mount Faucet

CR-RS Series
26" Wide Units With
Deck Mount Faucet



w/ Dump Sink & Faucet

- Dump Sink
- 4" Backsplash
- 15A - 120V GFI Duplex Outlet Hidden Beneath Shelf
- Recessed Step For Blenders
- Grommet Hole For Blender Power Cords
- 1" IPS Drain

- **SL-RS Series** Includes 4" O.C. Splash Mounted Swing Spout Faucet
- **CR-RS Series** Includes 4" O.C. Deck Mounted Swing Spout Faucet And Has Rear Deck For Extra Storage

Overall Length	23" WIDE	Price	Approx. Weight	Approx. Cu. Ft.	26" WIDE	Price	Approx. Weight	Approx. Cu. Ft.
12"	SL-RS-12	\$1550	20 lbs.	6	CR-RS-12	\$1617	21 lbs.	6
18"	SL-RS-18	1777	23 lbs.	6	CR-RS-18	1852	23 lbs.	6

BLENDER STATION ACCESSORIES & MODIFICATIONS



A-15



A-16

- A-15 Chrome Towel Ring (Packed Loose) — \$136
- A-16 Perforated Basket (Fits 10" x 14" x 7" & 10" x 14" x 10" Sinks) — 341
- A-17 Perforated Basket (Fits 9-1/2" x 11-1/2" x 6 Sink) — 334
- K-316-LU Add Weld Handles — 167
- SU-10A 18" Stainless Steel Leg Upgrade (Set of 4 -Includes Adjustable Front-to-Back Cross-Bracing) — 360

6" Stainless Steel Open Waste Chute
Fits 6" Dia. Cutout

A-6
\$182



Dipper Well Faucet

A-33
\$224



6" Dipper Well with Insert and Drain
Fits 6" Dia. Cutout

A-7
\$476



Water Filler Faucet

K-54
8-1/4" High \$744
K-54A
13" High \$845



Add SU-24 Cutout for A6 or A-7
\$135

UNI-SERV SPEED BAR

12" Deep Ice Bin w/ Dump Sink, Recessed Drainboard & Blender Station • 29" Working Height



CRU-60R Shown

- 4" Backsplash
- 26" Front To Back
- SPRK-30 - 30" Speed Rail
- 30" Insulated Ice Bin
- 98 lbs. Ice Bin Capacity
- Two Removable Plastic Bottle Racks
- Optional 7-Circuit Cold Plate Sealed Into The Bottom Of Ice Bin
- Dump Sink
- 4" O.C. Deck Mounted Swing Spout Faucet
- Recessed Drainboard for Glassware
- Dual Blender/Mixer Recess
- Galvanized Legs w/ Adjustable Plastic Bullet Feet & Adjustable Galvanized Side Cross-Bracing



15A - 120V GFI Duplex Receptacle Hidden Beneath Blender Shelf

Model #	Price	Overall Length	Approx. Weight	Approx. Cu. Ft.
CRU-60L or R	\$4831	60"	110 lbs.	23
w/ 7-CIRCUIT COLD PLATE				
CRU-60L-7 or R-7	6772	60"	193 lbs.	23

L And R Indicate Ice Bin Location

Underbar **Basics™**

BAR STORAGE

Beer & Liquor Storage

BEER BOX

18" Deep • 29" Working Height

- Perforated False Bottom Allows Melted Ice To Drain
- False Bottom Is Removable For Easy Cleaning
- 4" Backsplash
- Stainless Steel Legs w/ Adjustable Stainless Steel Bullet Feet
- 1" I.P.S. Drain



CRBB-48

Model #	Price	Overall Length	Ice Bin Liner Size W x L x H	Capacity of Bottled Beer	Approx. Weight	Approx. Cu. Ft.
CRBB-48	\$3176	48"	20 3/4" x 45 3/4" x 18"	12 cases	220 lbs.	14
CRBB-60	3399	60"	20 3/4" x 57 3/4" x 18"	18 cases	225 lbs.	15

Add SU-55 For Stainless Steel Divider add \$240 ea.

BEER BOX COVERS

Includes Two Padded Locks & Keys



Beer Box Covers Must Be Removed During Normal Operation

Model #	Description	Price
SU-35A	For 48" Beer Box	\$997
SU-35B	For 60" Beer Box	1253

LIQUOR DISPLAYS

Tiered Steps & Retaining Bars Securely Display Liquor Bottles



LD-1824

Liquor Display Rack

- Sound Deadened
- 4" Backsplash
- Galvanized Legs w/ Adjustable Plastic Bullet Feet
- Adjustable Galvanized Side Cross-Bracing
- 26" Wide Units Have Rear Deck For Extra Storage



CRLR-24

Liquor Display Cabinet

- Stainless Steel Cabinet
- 4" Backsplash
- Stainless Steel Legs w/ Adjustable Bullet Feet

Model #	Price	Overall Length	Approx. Bottle Capacity	Approx. Weight	Approx. Cu. Ft.
23" WIDE LD-1812	\$1420	12"	12	30 lbs.	15
LD-1818	1570	18"	20	35 lbs.	20
LD-1824	1898	24"	28	40 lbs.	30
26" WIDE LD-2112	1552	12"	12	30 lbs.	15
LD-2118	1752	18"	20	35 lbs.	20
LD-2124	1989	24"	28	40 lbs.	30

Model #	Price	Overall Length	Approx. Bottle Capacity	Approx. Weight	Approx. Cu. Ft.
21" WIDE CRLR-12	\$1697	12"	15	35 lbs.	7
CRLR-18	1975	18"	20	36 lbs.	10
CRLR-24	2393	24"	30	42 lbs.	13
CRLR-30	2463	30"	35	47 lbs.	14
CRLR-36	2620	36"	45	50 lbs.	15

REMOVABLE STAINLESS STEEL LIQUOR DISPLAY COVERS

Includes Padlock & Two Keys. Factory Installed Only.

Display Rack Cover

For LD Models Only



Length	Model #	Price
21" WIDE 10" WIDE 12"	LC-1812	\$718
18"	LC-1818	796
24"	LC-1824	877
12"	LC-2112	773
18"	LC-2118	853
24"	LC-2124	966

Display Cabinet Cover

For CRLR Models Only



Length	Model #	Price
21" WIDE 12"	LC-12	\$869
18"	LC-18	941
24"	LC-24	997
30"	LC-30	1115
36"	LC-36	1203

For Speed Rails, See Page 101.

BAR STORAGE

Glassware Storage

Glass Racks Not Included • Approximate Weights & Cubes Listed



Underbar Basics™

UNDERBAR STORAGE CABINETS

With Seamless & Embossed Drainboard Top

Drainboard Cabinets

- 21" Width (Front to Back)
- 4" Backsplash
- 1" IPS Drain In Back Right Corner Of Top
- 3" Diameter Drain Hole In Upper Right Corner Of Back Panel
- Stainless Steel Legs w/ Adjustable Bullet Feet



OPEN BASE
CRD-2B Shown



w/ MID-SHELF
CRD-2BM Shown



W/ MID-SHELF & DOOR
CRD-2BMD Shown

Size W x L x H	OPEN BASE		2 TIER STORAGE UNIT		2 TIER STORAGE UNIT WITH HINGED DOOR		Approx. Weight	Approx. Cu. Ft.
	Model #	Price	Model #	Price	Model #	Price		
21" x 24" x 33"	CRD-2B	\$2045	CRD-2BM	\$2503	CRD-2BMD	\$2732	50 lbs.	14
21" x 30" x 33"	CRD-30B	2143	CRD-30BM	2627	CRD-30BMD	2866	99 lbs.	18
21" x 36" x 33"	CRD-3B	2382	CRD-3BM	2874	CRD-3BMD	3113	140 lbs.	20
21" x 48" x 33"	CRD-4B	2586	CRD-4BM	3079	CRD-4BMD	3285	152 lbs.	20

24" Glass Rack Storage Unit



CRCR-24-CT

- 21" Width (Front to Back)
- 4" Backsplash
- Holds Up To 3 Glass Racks
- Stainless Steel Glass Rack Slides
- 1" IPS Drain In Back Right Corner Of Top
- 3" Diameter Drain Hole In Upper Right Corner Of Back Panel
- Stainless Steel Legs w/ Adjustable Bullet Feet

52 lbs. 13 Cu. Ft.

CRCR-24 \$2070

Flat Top - Drain Not Included

CRCR-24-CT \$2132

Corrugated Top

Cabinet w/ Dump Sink & Waste Chute



- 21" x 18" x 33"
- Includes 1 Hinged Door
- 9" x 9" x 4" Dump Sink
- 4" O.C. Splash Mounted Swing Spout Lead Free Compliant Faucet
- 5 1/2" Diameter Waste Chute
- Stainless Steel Legs w/ Adjustable Bullet Feet

64 lbs. 15 Cu. Ft.

CRDW-18 \$3149

Shown With Optional Door Lock and Wrist Handle Faucet

CABINET MODIFICATIONS & ACCESSORIES



Add A Sink \$1316

Splash Mount Faucet Included

SU-22A 10" x 14" x 10" Bowl

SU-22C 9" x 9" x 4" Bowl



Add A Door Lock

SU-27 \$451

• Includes 2 Keys



Add A Liquid Waste Chute With Filler Faucet

SU-36 \$1307

• 5 1/2" Dia. Liquid Waste Chute

• Includes K-54 Push-Back

Water Filler Faucet

(Meets Federal Lead Free Standards)



Add A Dipperwell Only

A-7 \$476

• 5 1/2" Diameter

• 1-1/2" NPT Drain Connection

• Factory installed. Includes TA-34 Cutout



WANT US TO CONNECT IT?

Add SU-24 \$199

Price Per Every Two Units

Underbar **Basics**

SPEED RAILS

Speed Rails

Speed Rail Features:

- Available In Lengths Measuring From 1 Ft. to 8 Ft.
- Provides Basic Bar Equipment With A Custom Lock
- Allows Extra Storage For Liquor Bottles

STANDARD SPEED RAILS



Stainless Steel Speed Rails

• Keyhole Installation

SINGLE		Price	Size W x L x H	Bottle Capacity	Wt.	Cu. Fl.	DOUBLE		Price	Size W x L x H	Bottle Capacity	Wt.	Cu. Fl.
BK-15	\$143	4 1/2" x 15" x 5 1/2"	4	4 lbs.	1	DT-15	\$267	8 1/2" x 15" x 7"	8-10	7 lbs.	1		
BK-2	145	4 1/2" x 24" x 5 1/2"	4-6	5 lbs.	1	DT-2	273	8 1/2" x 24" x 7"	10-12	8 lbs.	1		
BK-30	161	4 1/2" x 30" x 5 1/2"	8-9	6 lbs.	1	DT-30	292	8 1/2" x 30" x 7"	16-18	10 lbs.	1		
BK-3	168	4 1/2" x 36" x 5 1/2"	9-10	6 lbs.	1	DT-3	307	8 1/2" x 36" x 7"	18-20	11 lbs.	1		
BK-4	205	4 1/2" x 48" x 5 1/2"	12-13	8 lbs.	1	DT-4	371	8 1/2" x 48" x 7"	24-26	18 lbs.	1		



Single Tier
BK-2 Shown



Double Tier
DT-30 Shown

Black Plastic Speed Rails

- Injection Moulded Black Plastic Construction
- Packed 6 Per Carton (Must Order Qty. of 6)
- Liquor Bottle Capacity = 5 Per Speed Rail

Model #	Price	Size W x L x H	Wt.	Cu. Fl.
KS-2K	\$80	4 1/8" x 23" x 5 3/8"	16 lbs.	2



KS-2K

Add Strap Hangers
PR-STRAP \$68
For KS-2K Only



PR-STRAP

HEAVY DUTY STAINLESS STEEL SPEED RAILS



Keyhole Installation

Standard HD Speed Rails

SINGLE TIER
SRK-2 Shown



DOUBLE TIER
SRKD-18 Shown



SINGLE		Price	Size W x L x H	Cap.	DOUBLE		Price	Size W x L x H	Cap.	Wt. (lbs.)	Cu. Fl.
SRK-12	\$474	5 1/4" x 12" x 7 3/4"	3	SRKD-12	\$528	10 1/2" x 12" x 9 1/4"	6	8	1		
SRK-15	479	5 1/4" x 15" x 7 3/4"	4	SRKD-15	534	10 1/2" x 15" x 9 1/4"	8	9	1		
SRK-18	481	5 1/4" x 18" x 7 3/4"	4-5	SRKD-18	587	10 1/2" x 18" x 9 1/4"	8-10	10	1		
SRK-2	510	5 1/4" x 24" x 7 3/4"	5-6	SRKD-2	682	10 1/2" x 24" x 9 1/4"	10-12	13	1		
SRK-30	514	5 1/4" x 30" x 7 3/4"	7-8	SRKD-30	758	10 1/2" x 30" x 9 1/4"	14-16	16	1		
SRK-3	516	5 1/4" x 36" x 7 3/4"	9-10	SRKD-3	747	10 1/2" x 36" x 9 1/4"	18-20	18	1		
SRK-42	513	5 1/4" x 42" x 7 3/4"	11-12	SRKD-42	764	10 1/2" x 42" x 9 1/4"	22-24	20	2		
SRK-4	522	5 1/4" x 48" x 7 3/4"	13-14	SRKD-4	805	10 1/2" x 48" x 9 1/4"	26-28	22	2		
SRK-5	533	5 1/4" x 60" x 7 3/4"	15-18	SRKD-5	855	10 1/2" x 60" x 9 1/4"	30-36	26	2		
SRK-6	559	5 1/4" x 72" x 7 3/4"	19-22	SRKD-6	919	10 1/2" x 72" x 9 1/4"	38-44	28	2		
SRK-7	602	5 1/4" x 84" x 7 3/4"	23-26	SRKD-7	1007	10 1/2" x 84" x 9 1/4"	46-52	30	2		
SRK-8	614	5 1/4" x 96" x 7 3/4"	27-28	SRKD-8	1059	10 1/2" x 96" x 9 1/4"	54-56	32	2		

Make An Odd Length
Speed Rail
SU-41 \$96

Make Speed Rail Accommodate
1/2 Gallon Bottles
SU-42 \$128

Hang-On Style

- Removable
- Hangs On First Tier Of Any SRK Series Speed Rail
- Doubles Liquor Storage



SR-2H

Model #	Price	Size W x L x H	Cap.	Wt.	Cu. Fl.
SR-12H	\$257	6 1/4" x 12" x 8 1/2"	3	4 lbs.	1
SR-15H	266	6 1/4" x 15" x 8 1/2"	4	5 lbs.	1
SR-18H	275	6 1/4" x 18" x 8 1/2"	4-5	6 lbs.	1
SR-2H	281	6 1/4" x 24" x 8 1/2"	5-6	7 lbs.	1
SR-30H	299	6 1/4" x 30" x 8 1/2"	7-8	8 lbs.	1
SR-3H	316	6 1/4" x 36" x 8 1/2"	9-10	9 lbs.	1
SR-42H	328	6 1/4" x 42" x 8 1/2"	11-12	9 lbs.	2
SR-4H	334	6 1/4" x 48" x 8 1/2"	13-14	10 lbs.	2

Hang-On Style Speed Rails Are Not To Be Used
With Any Other Manufacturer's Speed Rails

For Liquor Racks, See Page 99.

PRESTIGE *Signature Series* MODULAR BAR DIE SYSTEM

Exclusively For Advance Tabco's Prestige Bar Equipment

Sample Modular Bar Die Layout

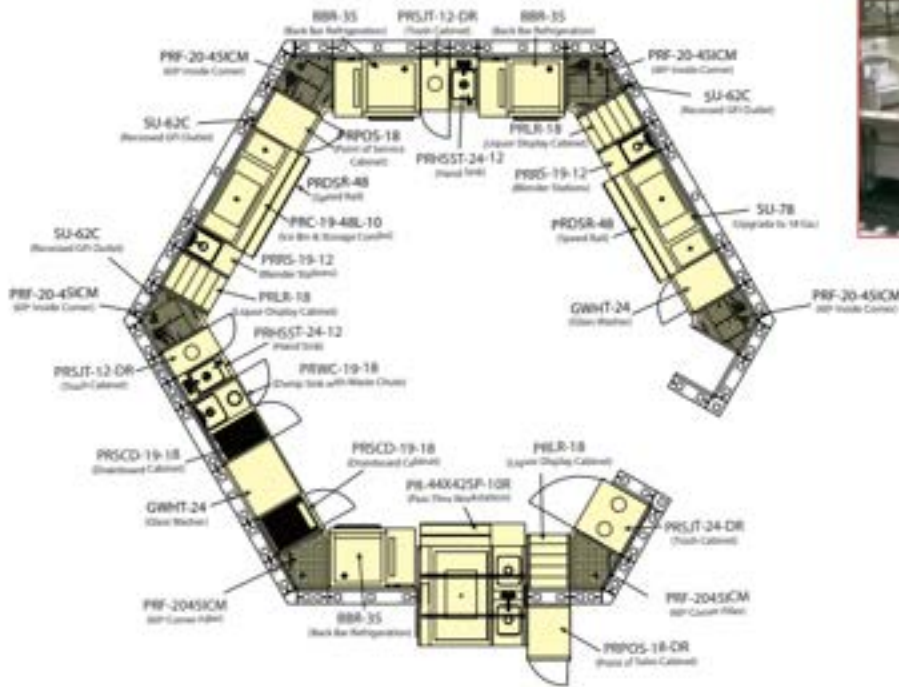

Actual Job Shown Set Up for Quality Check



Quality & Customer Satisfaction Is Our Top Priority!

Our factory takes the time to set up your entire Bar Die System to ensure all equipment properly fits and matches your specifications.

Floor Templates Available SU-82
Call Factory For Pricing



Bar Top And Drink Rail Can Be Fabricated From Equipment Drawings Ahead Of Time.

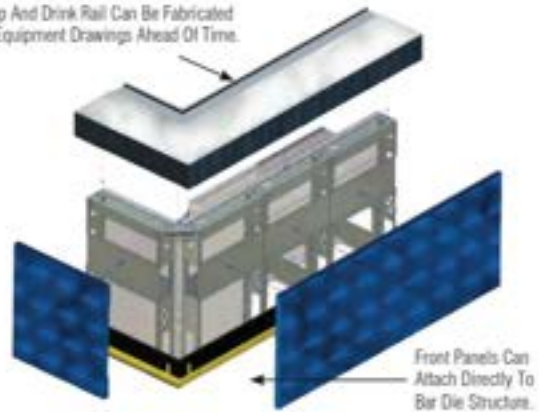

**Contact Our SmartFab Department For Details at
800-645-3166
or
SmartFab@advancetabco.com**

PRESTIGE *Signature Series* MODULAR BAR DIE SYSTEM



Exclusively For Advance Tabco's Prestige Bar Equipment

Bartender's Side Features:

- 20 Gauge, 302 Stainless steel
- Die Wall Can Be Sealed To The Floor, Eliminating Moisture In The Bar Structure.
- Recessed Equipment Outlets Allow Bar Equipment To Be Flush Against Bar Die Wall.
- GFI Outlets Set In Place (To Be Wired By Local Electrician To Meet Local Codes)
- Stainless Steel Panels Supplied Where Equipment By Others Is Located.
- Precise Engineering To Ensure An Exact Fit.
- Enclosed Casing For Beer Towers.
- Soda Gun Outlets Supplied (Location Must Be Specified).
- Cantilever System Made For Advance Tabco's Prestige Bar Equipment, Eliminating The Need For Legs.
- Pre-Defined Space For Plumbing And Drain Lines.

Galvanized Bar Die Wall
Stainless Steel Exterior On Bar Side, Galvanized Upright Structure
Model # PR-BARDIE
\$550 per foot

Stainless Steel Bar Die Wall
Stainless Steel Exterior On Bar Side, Stainless Steel Upright Structure
Model # PR-BARDIE-SS
\$655 per foot



Flat Panel Section
w/ Recessed Outlet



Ice Bin Section



Cabinet Section



**STAINLESS STEEL
DRAINBOARD FILLERS**

Bolt On To Sides Of Equipment
Multiple Angles Available • Optional Legs
(See Page 109)

Contact SmartFab Department For Details & Pricing



BAR DIE SYSTEM ACCESSORIES & MODIFICATIONS

Factory Installed Only - Except SU-BDB-100 (Supplied Loose For In Field Positioning)



**Recessed GFI
Duplex Outlet**
SU-62C \$685



Cool White LED Light 1.5 Watt
• Single Box w/ Cover Plate
• Power Supply & Wiring Not Included
SU-BDL-CW \$300 ea.



**Receptacle Box
Only**
SU-62F \$90



LED Light Power Supply
• 100 Watts
• Handles Up to 35 Lights
SU-BDT-100 \$339 ea.

Floor Templates Available

SU-82 Call For Price



Templates Are Printed On Paper Rolls
& Are Marked For Easy Alignment

PRESTIGE Signature Series Underbar Hand Sinks

NSF All Sinks Are NSF Approved

Featuring Deep Drawn Seamless Sink Bowls



All Prestige Hand Sinks Feature:

- Deep Drawn Seamless Sink Bowl
- 1 1/2" IPS, 3 1/2" Basket Drain
- 7" Backsplash
- Stainless Steel Legs w/ Stainless Steel Adjustable Bullet Feet
- Adjustable Stainless Steel Side Cross-Bracing (Except PRHSC series)

29" Working Height

All Faucets Included Meet Federal Lead Free Standards

STANDARD BAR HAND SINKS

- PRHS-19 Series Includes 4" O.C. Splash Mt. Swing Spout Faucet
- PRHS-24 Series Includes 4" O.C. Deck Mt. Swing Spout Faucet & Has Rear Deck For Extra Storage

L	w/ SPLASH MOUNT FAUCET				w/ DECK MOUNT FAUCET			
	20" WIDE	Price	Wt.	Cu.	25" WIDE	Price	Wt.	Cu.
12"	PRHS-19-12	\$1811	35 lbs.	8	PRHS-24-12	\$1890	28 lbs.	8
18"	PRHS-19-18	1837	40 lbs.	9	PRHS-24-18	1915	30 lbs.	9



PRHS-19-12 Shown

HAND SINKS WITH SOAP & TOWEL DISPENSER

- Deck Mount Soap Dispenser
- C-Fold Towel Dispenser
- PRHSST-19 Series Includes 4" O.C. Splash Mt. Swing Spout Faucet
- PRHSST-24 Series Includes K-124 Deck Mt. Faucet & Has Rear Deck For Extra Storage

L	w/ SPLASH MOUNT FAUCET				w/ DECK MOUNT FAUCET			
	20" WIDE	Price	Wt.	Cu.	25" WIDE	Price	Wt.	Cu.
12"	PRHSST-19-12	\$2201	53 lbs.	8	PRHSST-24-12	\$2269	58 lbs.	8
18"	PRHSST-19-18	2224	55 lbs.	9	PRHSST-24-18	2292	60 lbs.	9



PRHSST-24-12 Shown

HAND SINK ACCESSORIES & MODIFICATIONS



Add Wrist Handles
Available For Splash or Deck Mount Faucets
K-316-LU \$167



Chrome Towel Ring
Packed Loose
A-15 \$136



Replacement Soap Deck Mount Dispenser
K-12 \$211

K-123	Replacement Splash Mt. Faucet	\$493
K-124	Replacement Deck Mt. Faucet	479
SU-73	Add Mirror Finish <i>Factory Install Only</i>	582
SU-74	All Stainless Steel Construction Upgrade	692
SU-75	Add Welded Stainless Steel Cross-Bracing	166
SU-20R or L	Right or Left Side Splash for 20" Wide Unit	255
SU-20RL	Right & Left Side Splash for 20" Wide Unit	505
SU-25R or L	Right or Left Side Splash for 25" Wide Unit	304
SU-25RL	Right & Left Side Splash for 25" Wide Unit	678

For Our Full Line Of Accessories & Modifications, See Pages 118-120.



Featuring **Deep Draw Seamless Sink Bowls**

29" Working Height

All Faucets Included Meet Federal Lead Free Standards

NSF All Sinks Are NSF Approved

PRESTIGE
Signature Series

Underbar Multi-Use Hand Sinks

HAND SINK WITH DRAINBOARD

- One Piece Deep Draw 14" X 10" X 7" Sink Bowl With 2" Drain And Strainer Plate
- K-125 Splash Mount Swing Spout Faucet
- Sturdy Stainless Steel Base Cabinet
- Removable Perforated Drainboard Top
- Stainless Steel Legs With Adjustable Stainless Steel Bullet Feet
- 7" Backsplash

L	25" WIDE	Price	Wt.	Cu. Ft.
24"	PRCS-25-24	\$3177	74 lbs.	19

Features
Removable Perforated
Drainboard Top



HAND SINK WITH GLASS RINSER

- One Piece Deep Draw 9" x 9" x 4" Sink Bowl With 2" Drain And Strainer Plate
- K-125 Splash Mount Swing Spout Faucet
- 29" Working Height
- 7" Backsplash
- Stainless Steel Top, Apron, Sides, Legs And Adjustable Bullet Feet
- Stainless Steel Glass Rinsers With Removable Drainboard
- Adjustable Stainless Steel Side Cross-Bracing

L	25" WIDE	Price	Wt.	Cu. Ft.
18"	PRCS-25-12	\$2585	65 lbs.	7

Features
Removable Perforated
Drainboard Top



HAND SINK WITH GLASS RINSER & DIPPER WELL

- One Piece Deep Draw 14" x 10" x 7" Sink Bowl With 2" Drain And Strainer Plate
- K-125 Splash Mount Swing Spout Faucet
- 29" Working Height
- 7" Backsplash
- Stainless Steel Top, Apron, Sides, Legs And Adjustable Bullet Feet
- Dipper Well With A-33 Faucet
- Stainless Steel Glass Rinsers With Removable Drainboard
- Adjustable Stainless Steel Side Cross-Bracing

L	25" WIDE	Price	Wt.	Cu. Ft.
18"	PRCS-25-18	\$3456	80 lbs.	9

Features
Removable Perforated
Drainboard Top



HAND SINK WITH GLASS RINSER, DIPPER WELL & CUTTING BOARD

- One Piece Deep Draw 9" x 9" x 4" Sink Bowl With 2" Drain And Strainer Plate
- K-125 Splash Mount Swing Spout Faucet
- 29" Working Height
- 7" Backsplash
- Stainless Steel Top, Apron, Sides, Legs And Adjustable Bullet Feet
- Dipper Well With A-33 Faucet
- Stainless Steel Glass Rinsers With Removable Drainboard
- Adjustable Stainless Steel Side Cross-Bracing
- Removable 10" x 12" Poly Cutting Board

L	25" WIDE	Price	Wt.	Cu. Ft.
24"	PRSP-25-24	\$3490	80 lbs.	11

Features
Removable Perforated
Drainboard Top



WARNING: Equipment that includes a faucet may expose you to chemicals, including lead, that are known to the State of California to cause cancer or birth defects or other reproductive harm. For more info, visit www.p66warnings.ca.gov.

PRESTIGE Signature Series

NSF All Drainboards Are NSF Approved

Hand Sink Cabinets

HAND SINKS WITH CABINET BASE

- All Stainless Steel Cabinet Base
- Hinged Cabinet Door
- **PRHSC-19 Series** Includes 4" O.C. Splash Mt. Swing Spout Faucet
- **PRHSC-24 Series** Includes K-124 Deck Mt. Faucet & Has Rear Deck For Extra Storage



PRHSC-19-12 Shown

w/ SPLASH MOUNT FAUCET				w/ DECK MOUNT FAUCET			
L	20" WIDE	Price	Wt. Cu.	25" WIDE	Price	Wt. Cu.	
12"	PRHSC-19-12	\$2463	78 lbs. 9	PRHSC-24-12	\$2555	83 lbs. 10	
18"	PRHSC-19-18	2803	80 lbs. 9	PRHSC-24-18	2871	85 lbs. 10	

HAND SINK WITH BUILT-IN DUMP SINK & WASTE CHUTE **NSF**

- 9" x 9" x 4" Dump Sink
- 5-1/2" Diameter Waste Chute
- Optional Removable Hinged Doors (Add SU-27 For Door lock)
- 7" Backsplash
- Stainless Steel Legs w/ Adjustable Stainless Steel Bullet Feet
- **PRWC-19 Series** Includes 4" O.C. Splash Mt. Swing Spout Faucet
- **PRWC-24 Series** Includes 4" O.C. Deck Mt. Swing Spout Faucet & Has Rear Deck For Extra Storage



PRWC-19-18-DR Shown

L	Style	w/ SPLASH MT. FAUCET		w/ DECK MT. FAUCET		Approx. Wt.	Approx. Cu. Ft.
		25" WIDE	Price	30" WIDE	Price		
18"	w/ Hinged Door	PRWC-19-18-DR	3279	PRWC-24-18-DR	3341	67 lbs.	15

HAND SINK ACCESSORIES & MODIFICATIONS



Add Wrist Handles
Available For Splash or Deck Mount Faucets

K-316-LU \$167



Chrome Towel Ring
Packed Loose

A-15 \$136



Replacement Soap Deck Mount Dispenser

K-12 \$211

K-123	Replacement Splash Mt. Faucet	\$493
K-124	Replacement Deck Mt. Faucet	479
SU-73	Add Mirror Finish <i>Factory Install Only</i>	582
SU-74	All Stainless Steel Construction Upgrade	692
SU-75	Add Welded Stainless Steel Cross-Bracing	166
SU-20R or L	Right or Left Side Splash for 20" Wide Unit	255
SU-20RL	Right & Left Side Splash for 20" Wide Unit	505
SU-25R or L	Right or Left Side Splash for 25" Wide Unit	304
SU-25RL	Right & Left Side Splash for 25" Wide Unit	678

For Our Full Line Of Accessories & Modifications, See Pages 118-120.

106 **WARNING:** Equipment that includes a faucet may expose you to chemicals, including lead, that are known to the State of California to cause cancer or birth defects or other reproductive harm. For more info, visit www.p66warnings.ca.gov

Featuring Deep Drawn Seamless Sink Bowls

All Faucets Included Meet Federal Lead Free Standards



Featuring Perforated Drainboard

PRESTIGE
Signature Series
Underbar Sinks

NSF All Sinks Are NSF Approved

BAR SINKS

Featuring 10" x 14" x 10" Deep Drawn Seamless Bowls & 29" Working Height

- 7" High Backsplash
- Removable Perforated Drainboard Top
- 8" Overflow Pipe w/ 1 1/2" IPS Drain Included Per Sink Bowl
- Sound Deadened
- Stainless Steel Top, Apron, Sides
- Stainless Steel Legs w/ Adjustable Stainless Steel Bullet Feet

- Adjustable Stainless Steel Side Cross-Bracing
- **PRB-19 Series** Includes 1 - 4" O.C. Splash Mounted Swing Spout Faucet
- **PRB-24 Series** Includes 1 - 4" O.C. Deck Mounted Swing Spout Faucet & Has Rear Deck For Extra Storage



PRB-19 Series with Drainboards Shown
20" Wide Units Include Splash Mount Faucet(s)



PRB-24 Series
25" Wide Units With Deck Mount Faucets

L And R Indicate Sink Location. C Indicates Sink is Centered.

	w/ SPLASH MOUNT FAUCET			w/ DECK MOUNT FAUCET			O.A. Length	# of Drbds.	Drbd. Length	Approx. Weight	Approx. Cu. Ft.
	20" WIDE	Price	Spout Length	25" WIDE	Price	Spout Length					
1 COMP.	PRB-19-31C	\$2448	6"	PRB-24-31C	\$2585	6"	36"	2	12"	89 lbs.	12
2 COMP.	PRB-19-22C	2457	6"	PRB-24-22C	2528	6"	24"	N/A	N/A	89 lbs.	8
	PRB-19-32LorR	2641	6"	PRB-24-32LorR	2750	6"	36"	1	11"	89 lbs.	12
	PRB-19-42LorR	2774	6"	PRB-24-42LorR	2923	6"	48"	1	23"	105 lbs.	16
	PRB-19-42C	2774	6"	PRB-24-42C	2923	6"	48"	2	12"	105 lbs.	16
3 COMP.	PRB-19-33C	2852	10"	PRB-24-33C	2946	12"	36"	N/A	N/A	105 lbs.	12
	PRB-19-43LorR	3244	10"	PRB-24-43LorR	3391	12"	48"	1	11"	107 lbs.	16
	PRB-19-53LorR	3541	10"	PRB-24-53LorR	3749	12"	60"	1	23"	125 lbs.	20
	PRB-19-53C	3630	10"	PRB-24-53C	3841	12"	60"	2	12"	125 lbs.	20
	PRB-19-63C	3818	10"	PRB-24-63C	3923	12"	72"	2	18"	143 lbs.	24
	PRB-19-73C	3969	10"	PRB-24-73C	4124	12"	84"	2	24"	190 lbs.	42
	PRB-19-83C	4725	10"	PRB-24-83C	4952	12"	96"	2	30"	176 lbs.	48
4 COMP.	PRB-19-44C*	3560	6"	PRB-24-44C*	3682	6"	48"	N/A	N/A	107 lbs.	16
	PRB-19-64C*	4345	6"	PRB-24-64C*	4497	6"	72"	2	12"	147 lbs.	24
	PRB-19-74C*	4508	6"	PRB-24-74C*	4688	6"	84"	2	18"	163 lbs.	42
	PRB-19-84C*	5317	6"	PRB-24-84C*	5546	6"	96"	2	24"	178 lbs.	48

*4 Comp. Bar Sinks Include 2 - 6" Swing Spout Faucets

BAR SINK ACCESSORIES & MODIFICATIONS

SU-73 Add Mirror Finish (Factory Install Only)	\$582	SU-20R or L Right Or Left Side Splash For PRB-19 Series	\$255
SU-74 All Stainless Steel Construction Upgrade	692	SU-20RL Right & Left Side Splash For PRB-19 Series	505
SU-75 Add Welded Stainless Steel Cross-Bracing	166	SU-25R or L Right Or Left Side Splash For PRB-24 Series	304
SU-79 Additional Drainboard Length	195 Lin Ft.	SU-25RL Right & Left Side Splash For PRB-24 Series	678

WARNING: Equipment that includes a faucet may expose you to chemicals, including lead, that are known to the State of California to cause cancer or birth defects or other reproductive harm. For more info, visit www.p66warnings.ca.gov

PRESTIGE Signature Series Ice Bins

PRI & PRC Series Feature:

- Includes Two Removable Plastic Bottle Racks
- 1 3/4" Return w/ Soda Gun Knock Out (Cold Plate Models Only)
- 7" Backsplash
- Stainless Steel Top, Apron & Sides
- Stainless Steel Legs w/ Adjustable Stainless Steel Bullet Feet
- Adjustable Stainless Steel Side Cross-Bracing
- 1" IPS Drain (Non-Cold Plate Bin); 1/2" IPS Drain (Cold Plate Bin)
- **OPTIONAL** 10-Circuit Cold Plate Sealed Into The Bottom

All Bottle Racks Must Be Removed For NSF Compliance & For Use With Optional Cover
Quick Pour Bottles Not Included

NSF All Ice Bins Are NSF Approved



Soda Chase Provision (Tip-out)
SU-30 \$701
Only For Ice Bins w/ Backsplash



PRC-19-48LR



PRI-19-24-10

ICE BINS 29" Working Height

• PRI-24 Series Has Rear Deck For Extra Storage

Ice Bin Depth	Overall Length	Ice Bin Capacity	20" WIDE	Price	25" WIDE	Price	Approx. Weight	Approx. Cu. Ft.	
11" DEEP	12"	32 lbs.	PRI-19-12	\$1603	PRI-24-12	\$1548	45 lbs.	11	
	24"	70 lbs.	PRI-19-24	2027	PRI-24-24	1970	70 lbs.	11	
	30"	89 lbs.	PRI-19-30	2174	PRI-24-30	2296	75 lbs.	15	
	36"	108 lbs.	PRI-19-36	2306	PRI-24-36	2490	80 lbs.	15	
	42"	127 lbs.	PRI-19-42	3154	PRI-24-42	3419	85 lbs.	20	
15" DEEP	48"	146 lbs.	PRI-19-48	3304	PRI-24-48	3701	90 lbs.	20	
	24"	80 lbs.	PRI-19-24-XD	3021	PRI-24-24-XD	3125	85 lbs.	20	
	30"	121 lbs.	PRI-19-30-XD	2961	PRI-24-30-XD	3328	90 lbs.	27	
11" DEEP	36"	147 lbs.	PRI-19-36-XD	2633	PRI-24-36-XD	3572	95 lbs.	37	
	w/ 10-CIRCUIT COLD PLATE								
	24"	70 lbs.	PRI-19-24-10	4315	PRI-24-24-10	4526	140 lbs.	18	
	30"	89 lbs.	PRI-19-30-10	5167	PRI-24-30-10	5340	173 lbs.	24	
	36"	108 lbs.	PRI-19-36-10	5340	PRI-24-36-10	5610	150 lbs.	24	
15" DEEP	42"	127 lbs.	PRI-19-42-10	5408	PRI-24-42-10	5806	155 lbs.	31	
	48"	146 lbs.	PRI-19-48-10	6133	PRI-24-48-10	6533	160 lbs.	31	
	24"	80 lbs.	PRI-19-24-10-XD	5198	PRI-24-24-10-XD	5416	165 lbs.	20	
15" DEEP	30"	121 lbs.	PRI-19-30-10-XD	5990	PRI-24-30-10-XD	6145	175 lbs.	27	
	36"	147 lbs.	PRI-19-36-10-XD	6268	PRI-24-36-10-XD	7450	175 lbs.	27	

ICE BIN & BOTTLE STORAGE COMBO 11" Deep Insulated Ice Bin • 29" Working Height

- Welded Partition Between Bins
- PRC-24 Series Has Rear Deck For Extra Storage

L And R Indicate Ice Bin Location On Either Right Or Left Side. LR Indicates Ice Bin Is Centered.

Overall Length	# Of Independent Bins	Ice Bin Capacity	20" WIDE	Price	25" WIDE	Price	Approx. Weight	Approx. Cu. Ft.
36"	2	70/32 lbs.	PRC-19-36L or R	\$3190	PRC-24-36L or R	\$3309	105 lbs.	15
42"	2	89/32 lbs.	PRC-19-42L or R	3416	PRC-24-42L or R	3564	110 lbs.	20
48"	2	108/32 lbs.	PRC-19-48L or R	3651	PRC-24-48L or R	3826	120 lbs.	20
48"	3	32/70/32 lbs.	PRC-19-48LR	4483	PRC-24-48LR	4673	160 lbs.	22
54"	3	32/89/32 lbs.	PRC-19-54LR	4648	PRC-24-54LR	4839	165 lbs.	27
60"	3	32/108/32 lbs.	PRC-19-60LR	4835	PRC-24-60LR	5034	170 lbs.	27
w/ 10-CIRCUIT COLD PLATE								
36"	2	70/32 lbs.	PRC-19-36L-10 or R-10	5607	PRC-24-36L-10 or R-10	5733	165 lbs.	24
42"	2	89/32 lbs.	PRC-19-42L-10 or R-10	6015	PRC-24-42L-10 or R-10	5985	175 lbs.	31
48"	2	108/32 lbs.	PRC-19-48L-10 or R-10	6068	PRC-24-48L-10 or R-10	6240	185 lbs.	33
48"	3	32/70/32 lbs.	PRC-19-48LR-10	6907	PRC-24-48LR-10	7093	195 lbs.	33
54"	3	32/89/32 lbs.	PRC-19-54LR-10	7070	PRC-24-54LR-10	7261	200 lbs.	40
60"	3	32/108/32 lbs.	PRC-19-60LR-10	7251	PRC-24-60LR-10	7458	205 lbs.	40

*Reverse Ice Bin Capacities For L or R Models.

For Prestige Ice Bin Covers, See Page 119.

PRESTIGE Signature Series

Underbar Corner Drainboard & Fillers

NSF All Corner Drainboards & Fillers Are NSF Approved

All Units On This Page Feature A Removable Perforated Drainboard Top



90° CORNER DRAINBOARD

Includes Stainless Steel Legs w/ Adjustable Stainless Steel Bullet Feet

- Free-Standing Corner Drainboard
- 7" High x 1-3/4" Thick Backsplash
- 1" I.P.S. Drain

Model #	Price	Size* (A) x (B)	Approx. Weight	Approx. Cu. Ft.
PRFD-2020	\$1403	20" x 20"	68 lbs.	7
PRFD-2025	1482	20" x 25"	72 lbs.	12
PRFD-2030	1539	20" x 30"	78 lbs.	16
PRFD-2035	1665	20" x 35"	82 lbs.	16
PRFD-2520	1482	25" x 20"	69 lbs.	7
PRFD-2525	1554	25" x 25"	73 lbs.	12
PRFD-2530	1593	25" x 30"	79 lbs.	16
PRFD-2535	1747	25" x 35"	83 lbs.	16
PRFD-3020	1539	30" x 20"	78 lbs.	7
PRFD-3025	1593	30" x 25"	79 lbs.	12
PRFD-3030	1794	30" x 30"	82 lbs.	16
PRFD-3035	1880	30" x 35"	86 lbs.	16
PRFD-3520	1665	35" x 20"	82 lbs.	16
PRFD-3525	1747	35" x 25"	83 lbs.	16
PRFD-3530	1880	35" x 30"	86 lbs.	16
PRFD-3535	1984	35" x 35"	90 lbs.	16



PRFD-3020



PRFD-2030



Includes Stainless Steel Legs w/ Adjustable Stainless Steel Bullet Feet

A represents the distance on the left side from the back wall until the front edge of the left unit.
 B represents the distance on the right side from the back wall until the front edge of the right unit.

90° CORNER FILLERS

- Must Be Bolted to Existing Line Up Equipment
- 7" High x 1-3/4" Thick Backsplash
- Available On Left or Right Side
- 1" I.P.S. Drain

Inside Corner



PRF-20-90IC Shown

Outside Corner



PRF-20-90OC Shown

Model #	Price	Size (A) x (B)	Approx. Weight	Approx. Cu. Ft.
PRF-20-90IC or OC*	\$1498	20" x 20"	82 lbs.	16
PRF-25-90IC or OC*	1554	25" x 25"	84 lbs.	16

* IC = Inside Corner OC = Outside Corner

45° CORNER FILLERS

- Must Be Bolted to Existing Line Up Equipment
- 7" High x 1-3/4" Thick Backsplash
- 1" I.P.S. Drain

Inside Corner

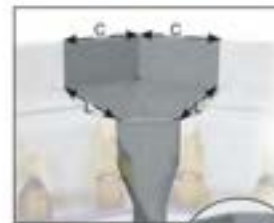

PRF-20-45IC Shown

Outside Corner



PRF-20-45OC Shown

	Model #	Price	Size L x W x H	C	Approx. Weight	Approx. Cu. Ft.
INSIDE CORNER	PRF-20-45IC	\$1148	20" x 20 3/8" x 21 5/8"	11 7/8"	82 lbs.	16
	PRF-25-45IC	1267	25" x 27 1/8" x 21 5/8"	14"	84 lbs.	16
OUTSIDE CORNER	PRF-20-45OC	1148	20" x 16 3/8" x 21 5/8"	8 7/8"	82 lbs.	16
	PRF-25-45OC	1267	25" x 20 1/4" x 21 5/8"	11"	84 lbs.	16

PLEASE NOTE: FILLERS BUILT TO ORDER & CAN NOT BE RETURNED

OPTIONAL LEGS & CUSTOM SIZES AVAILABLE
 Consult Factory For Details

PRESTIGE Signature Series Underbar Drainboards

NSF All Drainboards Are NSF Approved



Removable Perforated Drainboard Top

PRD & PRGS Series Feature:

- Removable Perforated Drainboard Top
- Stainless Steel Top, Sides & Legs w/ Adjustable Stainless Steel Bullet Feet

• Adjustable Stainless Steel Side Cross-Bracing

- 7" Backplash
- 1" IPS Drain
- Sound Deadened

29" Working Height

- Stainless Steel Apron
- **PRD-24 Series** has Rear Deck For Extra Storage

L	20" WIDE	Price	Approx. Weight	Approx. Cu. Ft.	25" WIDE	Price	Approx. Weight	Approx. Cu. Ft.
12"	PRD-19-12	\$1300	38 lbs.	8	PRD-24-12	\$1393	45 lbs.	10
18"	PRD-19-18	1334	45 lbs.	8	PRD-24-18	1459	52 lbs.	10
24"	PRD-19-24	1444	52 lbs.	8	PRD-24-24	1584	59 lbs.	10
30"	PRD-19-30	1591	59 lbs.	12	PRD-24-30	1688	66 lbs.	14
36"	PRD-19-36	1650	65 lbs.	12	PRD-24-36	1811	73 lbs.	14
42"	PRD-19-42	1926	70 lbs.	16	PRD-24-42	2122	79 lbs.	19
48"	PRD-19-48	2070	75 lbs.	16	PRD-24-48	2159	86 lbs.	19



PRD-19 Series 20" Wide Units



PRD-24 Series 25" Wide Units

RECESSED DRAINBOARDS

Holds Multiple Tiers Of Glassware • 18" Working Height

- 14" Side Splashes
- **PRGS-24 Series** has Rear Deck For Extra Storage

L	25" WIDE	Price	Approx. Weight	Approx. Cu. Ft.	30" WIDE	Price	Approx. Weight	Approx. Cu. Ft.
12"	PRGS-19-12	\$1044	40 lbs.	8	PRGS-24-12	\$1180	45 lbs.	10
18"	PRGS-19-18	1091	45 lbs.	8	PRGS-24-18	1183	52 lbs.	10
24"	PRGS-19-24	1174	52 lbs.	8	PRGS-24-24	1256	59 lbs.	10
30"	PRGS-19-30	1289	59 lbs.	12	PRGS-24-30	1412	66 lbs.	14



PRGS-19 Series 25" Wide Units



PRGS-24 Series 30" Wide Units

WANT TO UPGRADE? Add SU-74 For All Stainless Steel Construction \$516

GLASS RINSER FOR PERFORATED DRAINBOARDS (Activator Only) FACTORY INSTALLED ONLY				
SU-16P	\$993	4 1/4" Diameter	3 lbs.	1

FROZEN DRINK MACHINE STANDS

21" Working Height



PRFD-18

- Lower Working Height Accommodates The Height Of Most Drink Machines For Underbar Use
- Beveled Front
- Top Pitched To 1" IPS Drain
- Stainless Steel Top, Apron, Sides & Legs w/ Adjustable Stainless Steel Bullet Feet
- Adjustable Stainless Steel Side Cross-Bracing
- 15" Backplash

L	30" WIDE	Price	Wt.	Cu. Ft.
18"	PRFD-18	\$1715	57 lbs.	14
30"	PRFD-30	2422	80 lbs.	20

PRESTIGE Signature Series Drainboard Cabinets



Open Base
PRSCO-19-24 Shown



w/ Hinged Doors
PRSCD-24-24 Shown



All Stainless Steel Construction



Features
Removable Perforated
Drainboard Top

- Sturdy Base Cabinet
- Removable Perforated Drainboard Top
- Removable Hinged Doors
- 7" Backsplash
- Stainless Steel Legs w/ Adjustable Stainless Steel Bullet Feet
- 1" IPS Drain
- Sound Deadened

	L	25" WIDE	Price	Approx. Weight	Approx. Cu. Ft.	30" WIDE	Price	Approx. Weight	Approx. Cu. Ft.
OPEN BASE	12"	PRSCO-19-12	\$1790	48 lbs.	12	PRSCO-24-12	\$1960	55 lbs.	15
	18"	PRSCO-19-18	1954	55 lbs.	12	PRSCO-24-18	2124	62 lbs.	15
	24"	PRSCO-19-24	2175	62 lbs.	12	PRSCO-24-24	2331	69 lbs.	15
	30"	PRSCO-19-30	2584	69 lbs.	15	PRSCO-24-30	2740	76 lbs.	18
	36"	PRSCO-19-36	2979	75 lbs.	18	PRSCO-24-36	3139	82 lbs.	22
	42"	PRSCO-19-42	3357	80 lbs.	21	PRSCO-24-42	3515	90 lbs.	28
	48"	PRSCO-19-48	3766	85 lbs.	24	PRSCO-24-48	3924	92 lbs.	30
W/ HINGED DOORS	12"	PRSCD-19-12	2158	58 lbs.	12	PRSCD-24-12	2333	65 lbs.	15
	18"	PRSCD-19-18	2323	65 lbs.	12	PRSCD-24-18	2497	72 lbs.	15
	24"	PRSCD-19-24	2589	72 lbs.	12	PRSCD-24-24	2749	79 lbs.	15
	30"	PRSCD-19-30	3000	79 lbs.	15	PRSCD-24-30	3158	85 lbs.	18
	36"	PRSCD-19-36	3398	85 lbs.	18	PRSCD-24-36	3555	92 lbs.	22
	42"	PRSCD-19-42	3776	90 lbs.	21	PRSCD-24-42	4098	98 lbs.	28
	48"	PRSCD-19-48	4189	95 lbs.	24	PRSCD-24-48	4341	102 lbs.	30

PRSCO & PRSCD Series Modifications And Accessories

ADD MID-SHELF TO PRSCO SERIES \$600 /shelf

Add An "M" After The Model Number
(For example, PRSCO-19-18 would read PRSCO-19-18-M)

ADD A SINK (Includes Faucet)

10" x 14" x 10" SU-22A \$1316
9" x 9" x 4" SU-22C \$1316

6" Stainless Steel
Open Waste Chute
Fits 6" Dia. Cutout

A-6
\$182



Factory Installed

6" Dipper Well with
Insert and Drain
Fits 6" Dia. Cutout

A-7
\$476



Factory Installed. Includes TA-34 Cutout.

20" WIDE CABINETS AVAILABLE! Use 25" Wide Model # & Add SU-77 \$119 **LOCK IT UP!** Add A Door Lock SU-27 \$451

PRESTIGE Signature Series Trash Receptacles

TRASH RECEPTACLE CABINET WITH CHUTE

Trash Bin Not Included

- Open Bottom w/ Hinged Door
- Accommodates Slim Jim® Trash Can Measuring 11" x 20" x 25" (15 7/8 Gall. Cap.)
- S/S Legs w/ Adj. Stainless Steel Bullet Feet
- Overall Size: 12" x 25" x 33-3/4"
- 60 lbs. 9 Cu. Ft.

PRSJT-12-DR \$2219



PRSJT-DR

Shown With Slim Jim® Trash Can (Not Included)

TRASH RECEPTACLE COVER WITH CHUTE

Trash Bin Not Included

- Accommodates Slim Jim® Trash Can Measuring 11" x 20" x 25" (15 7/8 Gallon Capacity)
- Units Mount Between Equipment Line Up
- Overall Size: 12" x 25" x 9-3/4"
- 33 lbs. 4 Cu. Ft.

PRSJT-12 \$994



Shown With Slim Jim® Trash Can (Not Included)

TRASH RECEPTACLE COVER WITH DOOR

Trash Bin Not Included

- Open Bottom w/ Hinged Door
- Accommodates Slim Jim® Trash Can Measuring 11" x 20" x 25" (15 7/8 Gallon Capacity)
- Units Mount Between Equipment Line Up
- Removable S/S Sliding Cover
- Overall Size: 12" x 25" x 21-5/8"
- 35 lbs. 4 Cu. Ft.

PRT-12 \$1806



PRT-12

Shown With Slim Jim® Trash Can (Not Included)

POINT OF SERVICE CABINET



PRPOS-18-DR
Shown with Optional Door Lock



- 25" Working Height
- 11" High Backplash & Side Splashes
- Louvered Door w/ Flush Handle
- 2" Access Hole In Work Surface For Power Cord
- Stainless Steel Top, Apron, Sides & Legs With Adjustable Stainless Steel Bullet Feet

L	25" WIDE	Price	Wt.	Cu. Ft.
18"	PRPOS-18-DR	\$2904	60 lbs.	14
24"	PRPOS-24-DR	\$3246	150 lbs.	20

LOCK IT UP!
Add A Door Lock SU-27 \$451

Optional Legs Support

Model	Location	Price
SU-48L	Left	\$408
SU-48R	Right	\$408

(One Set Includes Two Legs with Cross-Brace)

For Models PRSJT-12 & PRT-12



PRESTIGE Signature Series Underbar Speed Bars & Bins

PASS-THRU ICE BINS

11" Deep Insulated Ice Bin • 29" Working Height

- Stainless Steel Top, Apron, Sides & Legs w/ Adjustable Stainless Steel Bullet Feet
- Adjustable Stainless Steel Side Cross-Bracing
- PRPT-2442-10 Has 10-Circuit Cold Plate Sealed Into The Bottom

For Sliding Stainless Steel Covers, See Page 119



Shown With Optional Speed Rail

Model #	Price	Size W x L x H	Ice Capacity	Wt.	Cu. Ft.
PRPT-2442	\$3288	42" x 24" x 29"	174 lbs.	80 lbs.	13
PRPT-2442-10	5716	42" x 24" x 29"	174 lbs.	150 lbs.	13



BEER BOX

18" Deep • 29" Working Height

- Perforated False Bottom Allows Melted Ice To Drain
- Removable False Bottom
- Stainless Steel Legs w/ Stainless Steel Bullet Feet
- 7" Backsplash



PRBB-48

Model #	Price	Size W x L x H	Capacity Of Bottle Beer	Wt.	Cu. Ft.
PRBB-48	\$4044	25" x 48" x 33"	12 Cases	220 lbs.	14
PRBB-60	4335	25" x 60" x 33"	18 Cases	205 lbs.	15

BEER BOX LOCKING COVERS

- Includes Padlock & 2 Keys
- SU-35C 48" Cover \$1076
 - SU-35D 60" Cover 1332

Add Stainless Steel Dividers
SU-55 \$240 ea.

Beer Box Covers Must Be Removed During Normal Operation

UNI-SERV SPEED BAR

Includes 30" Speed Rail • 7" Backsplash



PRU-24-60R Shown

- 48" Units: 9" x 9" x 4" Deep Drawn Sink Bowl
- 60" Units: 10" x 14" x 7" Deep Drawn Sink Bowl
- Recessed 18" Blender Station
- 3 1/2" Basket Drain
- Grommet Hole For Cord
- 30" x 11" Deep Insulated Ice Bin with Two Removable Plastic Bottle Racks
- Optional 10-Circuit Cold Plate Sealed Into The Bottom Of Ice Bin
- 1" I.P.S. Drain (1/2" I.P.S. Drain For Cold Plate Models)
- 7" Backsplash with 1 3/4" Return With Soda Gun Knock Out
- Recessed Drainboard with Removable Perforated Top with 1" I.P.S. Drain
- Stainless Steel Top, Apron, Sides & Legs with Stainless Steel Bullet Feet
- Adjustable Stainless Steel Side Cross-Bracing
- PRU-19 Series: 4" O.C. Splash Mounted Swing Spout Faucet
- PRU-24 Series: 4" O.C. Deck Mounted Swing Spout Faucet



15A - 120V GFI Duplex Receptacle Hidden Beneath Blender Shelf



L	25" WIDE			30" WIDE			Approx. Weight	Approx. Cu. Ft.
		O.A. Size	Price		O.A. Size	Price		
48"	PRU-19-48LorR	25"x48"	\$5210	PRU-24-48LorR	30"x48"	\$5790	135 lbs.	35
60"	PRU-19-60LorR	25"x60"	6111	PRU-24-60LorR	30"x60"	6188	135 lbs.	35
w/ 10-CIRCUIT COLD PLATE								
48"	PRU-19-48L-10orR-10	25"x48"	6933	PRU-24-48L-10orR-10	30"x48"	7601	170 lbs.	40
60"	PRU-19-60L-10orR-10	25"x60"	8532	PRU-24-60L-10orR-10	30"x60"	8611	170 lbs.	40

L and R Indicate Ice Bin Location.

PRESTIGE Signature Series Pass-Thru Units & Overshelves

PASS-THRU WORKSTATION NSF

With Two Deep Drawn Sink Bowls • 29" Working Height

- Stainless Steel Top & Sides
- Blender Shelf With Duplex Outlet Hidden Underneath
- Double Tier Speed Rail
- Tubing Chase For Soda Gun
- 15A - 120V GFI Duplex Outlet Hidden Beneath Shelf
- 4" O.C. Deck Mounted Lead Free Compliant Swing Spout Faucet
- Insulated Ice Bin w/ 10-Circuit Cold Plate Sealed into Bottom
- Stainless Steel Legs w/ Adjustable Stainless Steel Bullet Feet & Welded Cross-Bracing
- **Side Panel Models** include Removable Perforated Top w/ Drain & Front Apron; Units Are Supported By Side Panels & Do Not Require Legs



PR-44X42SP-10-L

Model #	Price	O.A. Length	Description	Ice Capacity	Approx. Weight	Approx. Cu. Ft.
PR-42X30-10-L or R	\$7481	42"	Stainless Steel Legs	70 lbs.	250 lbs.	38
PR-42X42-10-L or R	12403	42"	Stainless Steel Legs	174 lbs.	400 lbs.	58
SIDE PANELS WITH PERFORATED DRAINBOARD SHELF						
PR-44X30SP-10-L or R	10563	44"	Side Panels w/ Perforated Drbd. Shelf	70 lbs.	350 lbs.	59
PR-44X42SP-10-L or R	17806	44"	Side Panels w/ Perforated Drbd. Shelf	174 lbs.	575 lbs.	86

Dual Soda Gun Holder

- Openings for a single soda gun on each end
- Fits Prestige® Pass-Thru Workstations Only

SU-43 \$1352
Factory Installed Only

NOTE: To determine left or right hand model, Ice Bin is either Left (L) or Right (R) of the sink from the bartender side.

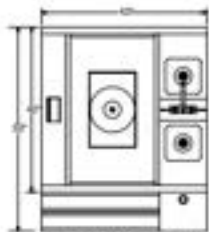

PR-42X42-10-L Shown

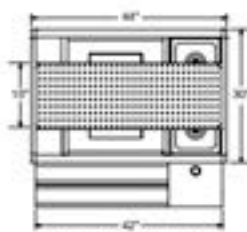

PR-44X30SP-10-L Shown

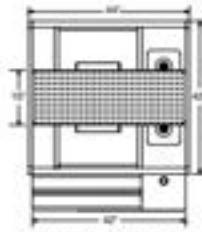

PR-44X42SP-10-L Shown

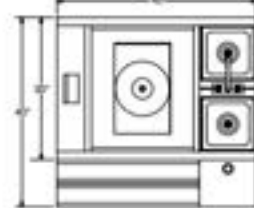

PR-42X30-10-L Shown

OVERSHELVES FOR PASS-THRU WORKSTATIONS

(For SP Models Only - Factory Installed)

- 44" Wide x 16 3/4" Length
- Removable Perforated Pans
- Square Stainless Steel Posts
- 20 Gauge, 300 Stainless Steel

-G Models:

- Include Stemware Glass Rack
- 18 Gauge, 302 Stainless Steel
- Stainless Steel Shelf With Splash On Three Sides



Single Shelf
PRSO-44-G Shown



Double Shelf
PRDO-44 Shown

Model #	Price	Description	Wt.	Cu. Ft.
PRSO-44	\$ 1672	Single Overshelf	65 lbs.	5
PRSO-44-G	2393	Single Overshelf w/ Stemware Glass Rack	85 lbs.	5
PRDO-44	2906	Double Overshelf	125 lbs.	17
PRDO-44-G	3955	Double Overshelf w/ Stemware Glass Rack	145 lbs.	17

114 **WARNING:** Equipment that includes a faucet may expose you to chemicals, including lead, that are known to the State of California to cause cancer or birth defects or other reproductive harm. For more info, visit www.p66warnings.ca.gov

All Blender Stations Are 

PRESTIGE
Signature Series

Free Standing Blender Stations

All Blender Stations Include:

- Stainless Steel Top, Apron
- Sides & Legs With Adjustable Stainless Steel Bullet Feet
- Adjustable Stainless Steel Side Cross-bracing



15A - 120V GFI Duplex Receptacle Hidden Beneath Blender Shelf

BLENDER STATION WITH DEEP DRAWN SINK



PRRS-19 Series
25" Wide Units With
Splash Mount Faucet



PRRS-24 Series
30" Wide Units With
Deck Mount Faucet

- Deep Drawn Sink
- Recessed Step w/ Grommet Hole For Blenders
- 7" Backplash
- 3 1/2" Basket Drain w/ 1 1/2" IPS
- Sound Deadened

- **PRRS-19 Series** Includes 4" O.C. Splash Mounted Swing Spout Faucet
- **PRRS-24 Series** Includes 4" O.C. Deck Mounted Swing Spout Faucet & Has Rear Deck For Extra Storage

Overall Length	w/ SPLASH MT. FAUCET				w/ DECK MT. FAUCET			
	25" WIDE	Price	Approx. Weight	Approx. Cu. Ft.	30" WIDE	Price	Approx. Weight	Approx. Cu. Ft.
12"	PRRS-19-12	\$1723	49 lbs.	9	PRRS-24-12	\$1891	51 lbs.	9
18"	PRRS-19-18	1849	56 lbs.	9	PRRS-24-18	2013	58 lbs.	12

BLENDER STATION WITH DRAINBOARD



PRDB-19 Series
25" Wide Units



PRDB-24 Series
30" Wide Units

- Removable Perforated Drainboard Top
- Recessed Step w/ Grommet Hole For Blenders
- 7" Backplash
- 1" IPS Drain

- Sound Deadened
- **PRDB-24 Series** Has Rear Deck For Extra Storage

Overall Length	25" WIDE				30" WIDE			
	Price	Approx. Weight	Approx. Cu. Ft.	Price	Approx. Weight	Approx. Cu. Ft.		
12"	PRDB-19-12	\$1156	45 lbs.	9	PRDB-24-12	\$1282	47 lbs.	9
18"	PRDB-19-18	1363	50 lbs.	9	PRDB-24-18	1502	53 lbs.	12

NOTE: Blender Stations Can Not Accommodate A Speed Rail

BLENDER STATION ACCESSORIES & MODIFICATIONS

- SU-73 Add Mirror Finish Factory Install Only — \$582
- SU-74 All Stainless Steel Construction Upgrade — 692
- SU-75 Add Welded Stainless Steel Cross-Bracing — 166

6" Stainless Steel Open Waste Chute
Fits 6" Dia. Cutout
A-6
\$182



Dipper Well Faucet
A-33
\$224



6" Dipper Well with Insert and Drain
Fits 6" Dia. Cutout
A-7
\$476



Water Filler Faucet
K-54
8-1/4" High **\$744**
K-54A
13" High **\$845**



Add SU-34 Cutout for A6 or A-7
\$135

 **WARNING:** Equipment that includes a faucet may expose you to chemicals, including lead, that are known to the State of California to cause cancer or birth defects or other reproductive harm. For more info, visit www.p66warnings.ca.gov

PRESTIGE Signature Series Glassware & Liquor Storage

Glass & Liquor Racks Not Included

GLASS RACK STORAGE CABINETS

Featuring All Stainless Steel Construction

- Holds Up To 3 Glass Racks
- Adjustable Glass Rack Slides
- 7" Backsplash
- 1" IPS Drain On Bottom Shelf
- Stainless Steel Legs w/ Adjustable Stainless Steel Bullet Feet
- 30" Wide Units Have Rear Deck For Extra Storage

Open Top



PROR-24-24 Shown

Drainboard Top



Removable Perforated Drainboard Top
1" IPS Drain

PRCR-19-24 Shown



Slanted Top

- Accommodates Liquor Rack On Slanted Top

PRSR-24-24 Shown

Model #	Price	Size	Wt.	Cu.
PROR-19-24	\$2826	24" x 25" x 36"	50 lbs.	12
PROR-24-24	2952	24" x 30" x 36"	57 lbs.	12

Model #	Price	Size	Wt.	Cu.
PRCR-19-24	\$2177	24" x 25" x 36"	80 lbs.	16
PRCR-24-24	2343	24" x 30" x 36"	85 lbs.	17

Model #	Price	Size	Wt.	Cu.
PRSR-19-24	\$3083	24" x 25" x 36"	50 lbs.	12
PRSR-24-24	3213	24" x 30" x 36"	57 lbs.	12



Add Stainless Steel Full Extension Roller Slides
SU-46 \$1300 /cabinet



Add Stainless Steel Concealing Drawer Front
Requires SU-46
SU-47 \$651 /cabinet

LIQUOR DISPLAYS

Tiered Steps & Retaining Bars Securely Display Liquor Bottles

PLD-2524





PRLR-24



Liquor Display Rack

- Retaining Bars Secure Bottles On Steps
- Sound Deadened
- 7" Backsplash
- Stainless Steel Top, Sides & Legs w/ Stainless Steel Bullet Feet
- Adjustable Stainless Steel Side Cross-Bracing
- 30" Wide Units Has Rear Deck For Extra Storage

	Model #	Price	Overall Length	Approx. Bottle Capacity	Approx. Weight	Approx. Cu. Ft.
25" WIDE	PLD-2512	\$1755	12"	15	25 lbs.	10
	PLD-2518	1856	18"	20	30 lbs.	10
	PLD-2524	2170	24"	30	35 lbs.	10
	PLD-2530	2312	30"	35	40 lbs.	14
	PLD-2536	2514	36"	45	50 lbs.	14
30" WIDE	PLD-3012	1969	12"	15	30 lbs.	12
	PLD-3018	2042	18"	20	35 lbs.	12
	PLD-3024	2184	24"	30	40 lbs.	12
	PLD-3030	2346	30"	35	45 lbs.	17
	PLD-3036	2553	36"	45	55 lbs.	17

Liquor Display Cabinet

- All Stainless Steel Construction
- 7" Backsplash
- Stainless Steel Legs w/ Adjustable Stainless Steel Bullet Feet

	Model #	Price	Overall Length	Approx. Bottle Capacity	Approx. Weight	Approx. Cu. Ft.
25" WIDE	PRLR-12	\$1900	12"	15	35 lbs.	7
	PRLR-18	2004	18"	20	36 lbs.	10
	PRLR-24	2103	24"	30	42 lbs.	13
	PRLR-30	2273	30"	35	47 lbs.	14
	PRLR-36	2506	36"	45	50 lbs.	15

REMOVABLE STAINLESS STEEL LIQUOR DISPLAY COVERS

Includes Padlock & Two Keys



Display Rack Cover
For PLD Models Only

	Length	Model #	Price
25" WIDE	12"	PRLC-2512	\$935
	18"	PRLC-2518	1015
	24"	PRLC-2524	1096
	30"	PRLC-2530	1179
	36"	PRLC-2536	1260
30" WIDE	12"	PRLC-3012	1034
	18"	PRLC-3018	1293
	24"	PRLC-3024	1357
	30"	PRLC-3030	1406
	36"	PRLC-3036	1454



Display Cabinet Cover
For PRLR Models Only

	Length	Model #	Price
25" WIDE	12"	PRLC-12	\$1130
	18"	PRLC-18	1332
	24"	PRLC-24	1448
	30"	PRLC-30	1506
	36"	PRLC-36	1592

For Prestige Speed Rails, See Pages 117.

COVERS ARE FACTORY INSTALLED ONLY



ALL STAINLESS STEEL SPEED RAILS ^{NSF} For Prestige Underbar Equipment

- Sound Deadened
- Bolt Holes For Mounting

Single & Double Tier Options Available



Single Tier
PRSSR-36 Shown



Double Tier
PRDSR-36 Shown

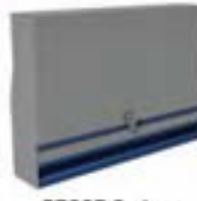

PRSSR Series
w/ Locking Cover



PRDSR Series
w/ Locking Cover

L	STANDARD SPEED RAILS						W/ LOCKING COVER <small>Includes Keyed Lock</small>						Approx. Wt.	Approx. Cu. Ft.
	SINGLE	Price	Cap.	DOUBLE	Price	Cap.	SINGLE	Price	Cap.	DOUBLE	Price	Cap.		
12"	PRSSR-12	\$540	3	PRDSR-12	\$674	6	PRSSR-12-LC	\$876	3	PRDSR-12-LC	\$1103	6	8 lbs.	1
18"	PRSSR-18	555	4	PRDSR-18	765	8	PRSSR-18-LC	1005	4	PRDSR-18-LC	1361	8	10 lbs.	2
24"	PRSSR-24	574	6	PRDSR-24	848	12	PRSSR-24-LC	1075	6	PRDSR-24-LC	1520	12	12 lbs.	2
30"	PRSSR-30	595	7	PRDSR-30	932	14	PRSSR-30-LC	1146	7	PRDSR-30-LC	1688	14	14 lbs.	3
36"	PRSSR-36	615	9	PRDSR-36	1007	18	PRSSR-36-LC	1216	9	PRDSR-36-LC	1837	18	14 lbs.	3
42"	PRSSR-42	630	10	PRDSR-42	1095	20	PRSSR-42-LC	1292	10	PRDSR-42-LC	2008	20	16 lbs.	4
48"	PRSSR-48	647	12	PRDSR-48	1179	24	PRSSR-48-LC	1364	12	PRDSR-48-LC	2173	24	16 lbs.	4
54"	PRSSR-54	671	13	PRDSR-54	1264	26	NOT AVAILABLE						18 lbs.	5
60"	PRSSR-60	690	15	PRDSR-60	1343	30							20 lbs.	5
72"	PRSSR-72	724	18	PRDSR-72	1511	36							24 lbs.	6
84"	PRSSR-84	764	21	PRDSR-84	1674	42							28 lbs.	7
96"	PRSSR-96	802	24	PRDSR-96	1822	48							32 lbs.	8

Hang-On Style Speed Rails

- Designed To Hang-on The First Tier Of Any PRSSR Series Speed Rails
- Doubles Liquor Storage
- Removable

Not To Be Used With Any Other Manufacturer's Speed Rails



L	Model #	Price	Cap.	Approx. Wt.	Approx. Cu. Ft.
12"	PRHSR-12	\$562	3	4 lbs.	1
18"	PRHSR-18	582	4	4 lbs.	2
24"	PRHSR-24	602	6	5 lbs.	2
30"	PRHSR-30	644	7	6 lbs.	2
36"	PRHSR-36	644	9	6 lbs.	3
42"	PRHSR-42	662	10	7 lbs.	3
48"	PRHSR-48	688	12	7 lbs.	4

For Prestige Liquor Racks & Cabinets, See Page 107.

BLENDER SHELVES Mounts To The Front Apron Of Ice Bin

- All Stainless Steel Construction
- 10" Wide
- Grommet Hole For Blender Power Cords
- 15A - 120V Duplex Outlet Hidden Beneath Blender Shelf
- Keyhole Installation



15A - 120V Duplex Receptacle Hidden Beneath Blender Shelf



EXCLUSIVELY
For Prestige Underbar Equipment

PRA-BS-12	12" Shelf	\$355
PRA-BS-18	18" Shelf	380
PRA-BS-24	24" Shelf	433
PRA-BS-30	30" Shelf	449

For Free-Standing Blender Stations,
See Page 115.

UNDERBAR ACCESSORIES

Underbar Modifications & Accessories

More Underbar Accessories			
A-1	Perforated Cover for 10" x 14" x 10" Sink Bowl	---	\$171
A-8	24" Condiment Rack (5 Condiment Cups) Condiment Racks Hang On Backsplash Of Ice Bin	---	836
SU-17	Interior Partition (For Underbar Basics & Prestige Drainboard Cabinets - Factory Installed Only)	---	299
K-12	Replacement Deck Mounted Soap Dispenser	---	211
SU-55	Removable Stainless Steel Divider For Beer Box	---	240
Underbar Modifications			
A-51	6" Hole in Drainboard Surface (Waste Chute Installation)	---	208
PR-STRAP	Stainless Steel Straps For Speed Rails (Set of 2 - For KS-2K Speed Rail Only)	---	68
SU-4	Modify Prestige Series Backsplash to 4" Tall	---	33 Lin. Ft.
SU-10A	Upgrade To S/S Legs & Bullet Feet (18" Legs - Includes Adjustable Front-to-Back Cross-Bracing)	---	360 Pair
SU-10B	Upgrade To S/S Legs & Bullet Feet (10" Legs - Includes Adjustable Front-to-Back Cross-Bracing)	---	347 Pair
SU-10C	Upgrade To S/S Legs & Bullet Feet (14" Legs - Includes Adjustable Front-to-Back Cross-Bracing)	---	360 Pair
SU-13	Upgrade to 10-Circuit Cold Plate (Applies to units with 7-Circuit Cold Plate)	---	637
SU-18RorL	Right or Left Welded Side Splash for 18" Wide Unit	---	229
SU-18RL	Right & Left Welded Side Splash for 18" Wide Unit	---	463
SU-21RorL	Right or Left Welded Side Splash for 21" Wide Unit	---	250
SU-21RL	Right & Left Welded Side Splash for 21" Wide Unit	---	450
SU-22A	Add 10"x14"x10" Sink To Drbd. Cabinet (Includes Splash Mt. Faucet)	---	1316
SU-22C	Add 8" x 8" x 4" Sink To Drbd. Cabinet (Includes Splash Mt. Faucet)	---	1316
SU-24	Provision To Connect Underbar Equipment (Price Per Every Two Units)	---	199
SU-30	Soda Chase Provision - Tip-Out (For Ice Bins w/ Backsplash Only)	---	637
SU-33	Working Height to Underbar Equipment	---	135
SU-34	Top Cutout for Under Bar Equipment	---	135
SU-36	Add 5-1/2" Diameter Waste Chute (Blender Stations & Drainboard Cabinets Only)	---	1089
SU-40	Prep Unit For Installation Of Speed Rails	---	116
SU-41	Make Speed Rail An Odd Length	---	96
SU-42	Make Speed Rail Accommodate 1/2 Gallon Bottles	---	128
SU-49	Add A 7-Circuit Cold Plate To D-24-WSIBL2 Or SLDRCR Series Ice Bins	---	2584
SU-61	Special Sizing To Reduce Length	---	N/C
SU-61A	Special Modification	---	355
SU-62C	Recess GFI Outlet For Bar Die	---	685
SU-68	Omit Curvation On Drainboard (Flat Top Work Surface)	---	207
SU-79	Additional Drainboard Length (Flat Top Work Surface)	---	195 Lin. Ft.

BASICS SINGLE SODA GUN HOLDER (Holds One Gun On One Side)

Model #	Price	Size* L x W x H	Approx. Weight	Approx. Cu. Ft.
CRSH-4	869	21" x 4" x 36"	19 lbs.	3
CRSH-6	869	21" x 6" x 36"	19 lbs.	3

PERFORATED BASKETS FOR UNDERBAR SINKS



A-16 \$341 Fits 10" x 14" x 7" & 10" x 14" x 10" Sinks	A-17 \$334 Fits 9 1/2" x 11 1/2" x 6" Sink A-17A \$345 Fits 9" x 9" x 4" Sink	A-23 \$318 Fits 8" x 11" x 6" Sink
---	--	--

REMOVABLE BLACK PLASTIC BOTTLE RACKS



A-19 \$23 ea. Single Bottle Rack 5 1/4" x 5 1/4"	A-20 \$70 ea. 3-Pack Bottle Rack (8 Per Carton, Must Order in Qty. of 6) 5 1/4" x 10 7/8"	A-18 \$61 ea. 4-Pack Bottle Rack 5" x 10 1/2"
---	---	--

STAINLESS STEEL FALSE BOTTOM



A-41	For 24" Ice Bin.....	\$161
A-42	For 30" Ice Bin.....	174
A-43	For 36" Ice Bin.....	194
A-44	For 42" Ice Bin.....	208
A-45	For 48" Ice Bin.....	222

SLIDING STAINLESS STEEL COVER For Free-Standing Underbar Basics Ice Bins



SSC-12	For 12" Ice Bin	\$240
SSC-24	For 24" Ice Bin	268
SSC-30	For 30" Ice Bin	297
SSC-36	For 36" Ice Bin	318
SSC-42	For 42" Ice Bin	363
SSC-48	For 48" Ice Bin.....	374
SSC-PT	For Pass-Thru Ice Bin.....	479

Replacement Sliding S/S Covers For Drop-in Ice Bins, See Page 92

STAINLESS STEEL ICE BIN PARTITION



14 3/4" Wide	A-38	8" High.....	\$174
	A-39	12" High.....	174
	A-40	16" High.....	174

BLENDER SHELF

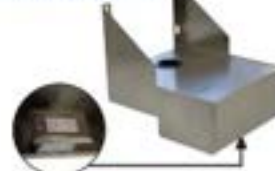

A-24 \$240
• 8" x 8" Add-On Blender Shelf
• Duplex GFI Outlet Beneath Shelf
• Grommet Hole For Power Cord

WRIST HANDLES FOR FAUCETS



K-316-LU \$167
Add Wrist Handles
For Deck Or Splash Mt. Faucets
Set Of 2

UNDERBAR ACCESSORIES

Prestige Underbar Modifications & Accessories

Prestige Ice Bin Accessories



PRA-BR-3	3-Bottle Well Support Frame For Ice Bin (For 20" Wide Units & Required For Use w/ Cover - Bottle Wells Not Included - Use A-20)	—	\$167
PRA-2405	24" Condiment Rack (Five 1/2" Removable Plastic Condiment Cups. Racks Hang On Backsplash Of Ice Bin)	—	724

Prestige Bar Sink Accessories

SU-20RoR	Right or Left Side Splash for 20" Wide Unit	—	255
SU-20RL	Right & Left Side Splash for 20" Wide Unit	—	505
SU-25RoR	Right or Left Side Splash for 25" Wide Unit	—	304
SU-25RL	Right & Left Side Splash for 25" Wide Unit	—	678

Prestige Underbar Modifications

SU-4	Modify Prestige Series Backsplash to 4" Tall	—	33	Lin. Ft.
SU-12A	13" S/S "H" Leg Assembly (Includes Adjustable Front-to-Back Cross-Bracing)	—	347	Pair
SU-12B	S/S "H" Leg Assembly For Extra Deep Ice Bins (Includes Adjustable Front-to-Back Cross-Bracing)	—	347	Pair
SU-27	Cabinet Door Lock w/ Key	—	451	
SU-30	Soda Chase Provision (For Ice Bins w/ Backsplash Only)	—	637	
SU-36	Add Waste Chute (Blender Stations Only)	—	1089	
SU-44	Add S/S Glass Rack Slides (Prestige Glass Rack Storage Cabinets Only)	—	780	2/Set
SU-46	Add S/S Full Extension Roller Slides (Prestige Glass Rack Storage Cabinets Only)	—	1300	
SU-47	Add S/S Concealing Drawer Front (Prestige Glass Rack Storage Cabinets Only)	—	651	
SU-62C	Recess GFI Outlet For Bar Die (Wiring by Others)	—	685	
SU-73	Add Mirror Finish Factory Install Only	—	582	
SU-74	All Stainless Steel Construction Upgrade	—	692	
SU-75	Add Welded Stainless Steel Cross-Bracing	—	166	
SU-77	Modify Cabinet to be 25" Wide (Prestige Drainboard Cabinets Only)	—	119	

PRESTIGE SODA GUN HOLDER

Mounts In Prestige Underbar Line Up

- Provides Housing For WunderBar® Soda Gun (14 Button or Smaller)
- Built-In Soda Gun Holder with Drip Cup
- Cover Allows Easy Access To Make Adjustments
- Keeps Tubing Lines Hidden For A Cleaner Workspace
- Includes Backsplash



SINGLE SODA GUN HOLDER (Holds One Gun On One Side)

Model #	Price	Size* L x W x H	Approx. Weight	Approx. Cu. Ft.
PRSH-19-4	\$948	20" x 4" x 36"	19 lbs.	3
PRSH-19-6	948	20" x 6" x 36"	19 lbs.	3
PRSH-24-4	1080	25" x 4" x 36"	20 lbs.	3
PRSH-24-6	1080	25" x 6" x 36"	20 lbs.	3

*Height is from the finished floor to the top of the splash
NOTE: Drain Connection Is Required On Drip Cup



PRESTIGE Signature Series



TUBING CHASE

PRA-19-TC	For 20" Unit.....	\$288
PRA-24-TC	For 25" Unit.....	300

STAINLESS STEEL TRASH RECEPTACLE COVER

Trash Bin Not Included • Factory Install Only



PRSJT-12 \$994

- Open Unit
- Accommodates Slim Jim® Trash Can Measuring 11" x 20" x 25" (15.78 Gallon Capacity)*
- Units Mount Between Equipment Line Up
- Overall Size: 12" x 25" x 21"
- 33 lbs. 4 Cu. Ft.



SLIDING STAINLESS STEEL COVERS

For Ice Bins

PRA-SSC-12	Fits 12" Ice Bin	\$275
PRA-SSC-18	Fits 18" Ice Bin	279
PRA-SSC-24	Fits 24" Ice Bin	285
PRA-SSC-30	Fits 30" Ice Bin	310
PRA-SSC-36	Fits 36" Ice Bin	334
PRA-SSC-42	Fits 42" Ice Bin	419
PRA-SSC-48	Fits 48" Ice Bin	430
PRA-SSC-PT30	Fits PR-44X30SP-10L or R & PR-42X30-10L or R	614
PRA-SSC-PT42	Fits PRPT-2442, PRPT-2442-10, PR-44X42SP-10L or R & PR-42X42-10L or R	659

PRESTIGE UNDERBAR ADD-ONS

Stainless Steel Underbar Fillers

Multiple Angles Available • Optional Legs



Corner Filler Shown

- Removable Perforated Drainboard Top
 - Bolt On To Sides Of Equipment
 - For Odd Shape Underbar Line Ups
- (See Page 100)



Stainless Steel Base Cabinet

Available With Or Without Doors

- Provides Extra Storage In Bar Line Up
- Optional Door Lock

Contact Our SmartFab Department For Details & Pricing.
SmartFab@advancetabco.com • 800-645-3166

FAUCETS

Underbar Equipment Faucets

All Items on This Page Ship via UPS

All Faucets Meet Federal Lead Free Standards

UNDERBAR DECK MOUNTED SINK FAUCETS

IMPROVED!
Temper Actuator

6" Deck Mounted Faucet

K-51 **\$663**
4" O.C.



3-1/2" Gooseneck

K-52 **\$331**
4" O.C.



12" Swing Spout

K-53 **\$626**
4" O.C.



Water Filler Faucet

K-54
8-1/4" High **\$744**
K-54A
13" High **\$845**



Deck Mt. 6" Extended Spout 4" O.C.

K-124 **\$479**

K-208 **\$653**
With Wrist Handles



Dipper Well Faucet

A-33 **\$224**



Gooseneck Deck Mount Melt Down Nozzle 4" O.C.

A-29 **\$732** A-30 **\$836** (installed)



UNDERBAR SPLASH MOUNTED SINK FAUCETS

3-1/2" Splash Mounted Faucet

K-59 **\$331**
4" O.C.



Extra Heavy Duty Splash Mounted Faucet

K-69 **\$651**
4" O.C.



Splash Mt. 6" Extended Spout 4" O.C.

K-123 **\$493**



Splash Mt. 6" Extended Spout with Wrist Handles

K-206 **\$624**
4" O.C.



6" Splash Mounted Faucet

K-125 **\$432**
4" O.C.



10" Splash Mounted Spout

K-126 **\$432**
4" O.C.



Wrist Handles for Faucets (Excludes K-69)
K-316-LU **\$167**



UNDERBAR SINK ACCESSORIES

WASTE OUTLETS & CHUTES

1" Waste Outlet

A-10 (6 per carton) **\$26**



1-1/2" Waste Outlet

A-11 (6 per carton) **\$28**



6" Stainless Steel Open Waste Chute Fits 6" Dia. Cutout



A-6 **\$182**

6" Dipper Well with Insert and Drain Fits 6" Dia. Cutout



A-7 **\$476**

1-1/2" NPT Drain Connection

Add SU-34 Cutout for A6 or A-7 **\$135**

STAINLESS STEEL OVERFLOW PIPES



1" Pipe (6 per carton)

A-12 **\$26 ea.**



1-1/2" Pipe (6 per carton)

A-13 **\$28 ea.**

(Price per each, sold in a carton of 6. Broken carton price \$25.00 list per each)

SOAP DISPENSERS & HOLDERS

Deck Mounted Soap Dispenser

K-12 **\$211**



Chrome Towel Ring (Packed Loose)

A-15 **\$136**



PORTABLE BARS

Heavy Duty Portable Bars

ALL STAINLESS STEEL INTERIOR! Designed For Heavy-Duty, High Volume Operation!

HEAVY DUTY OPEN BASE

- All Stainless Steel Bartender Side
- 19" x 13-1/2" x 11" Stainless Steel Integral Insulated Ice Bin with Cover
- Full Perimeter Bumpers
- 5" Heavy Duty Swivel Plate Casters (2 w/ Brakes)

- Drain & Shut-Off Valve
- Stainless Steel Speed Rails
- Open Bottom Shelf For Glass Rack Storage



Bar Top, Front, & Sides Material	Model	Price	Length	Width	Bar Top Width	# Of Speed Rails	Speed rail Capacity	Wt.	Cu. Ft.
Black Mica	AMS-5B	\$8590	62 1/4"	27 1/4"	12"	2	10 Btls.	315 lbs.	70
Black Mica	AMS-6B	9544	74 3/8"	27 1/4"	12"	3	15 Btls.	399 lbs.	73



HEAVY DUTY WITH DOORS

- All Stainless Steel Bartender Side
- 19" x 13-1/2" x 11" Stainless Steel Integral Insulated Ice Bin With Cover
- Full Perimeter Bumpers
- 5" Heavy Duty Swivel Plate Casters (2 w/ Brakes)
- Drain & Shut-Off Valve

- Stainless Steel Speed Rails
- Bottom Shelf For Glass Rack Storage
- Center Stainless Steel Panel For Extra Support
- Hinged Door With Lock On Left & Right Side Of Center Support Panel

Bar Top, Front, & Sides Material	Model	Price	Length	Width	Bar Top Width	# Of Speed Rails	Speed rail Capacity	Wt.	Cu. Ft.
Black Mica	AMD-5B	\$9578	62 1/4"	28 1/8"	12"	2	10 Btls.	423 lbs.	71
Black Mica	AMD-6B	10534	74 3/8"	28 1/8"	12"	3	15 Btls.	464 lbs.	73



Upgrade with Cold Plates - Add suffix -7 after model # and add \$2014 to Bars cost.
See Page 122 For All Portable Bar Modifications & Accessories.

Laminates & Stainless Steel Panels for Portable Series Bars

Add model number at end of Portable bar model number when ordering & add additional cost.
(Example: AMD-6B-LCW)



-LMP Add \$2684
Marula Pine
Exterior front & sides only



-LCW Add \$2684
Columbian Walnut
Exterior front & sides only



-LCM Add \$2684
Calcutta Marble
Exterior front & sides only



-SS Add \$4692
All Stainless Steel
Including Top



Need a Custom Color?



Custom Colors Available
SU-81
Consult Factory For Pricing & Details

See Page 122 For Even More Options

PORTABLE BARS

Portable Bars



**Designed For Heavy-Duty Use.
Perfect for High Volume Operation!**

STANDARD BLACK MICA BAR

- All Black Mica Finish
- Stainless Steel Countertop
- 19" x 13-1/2" x 11" Stainless Steel Integral Insulated Ice Bin With Cover
- Drain & Shut-Off Valve
- Open Bottom Shelf For Glass Rack Storage
- Towel Ring
- Dual Plastic Speed Rails (10 Bottle Capacity)
- 4" Swivel Plate Casters (2 w/ Brakes)

Top, Front, Back & Sides Material	Model	Price	Length	Width	Bar Top Width	Wt.	Cu. Ft.
Black Mica	D-B	\$6786	61"	24.50"	11"	310 lbs.	60



D-B Bartender Side Shown

BAR WITH ALL STAINLESS STEEL WORK AREA

- Stainless Steel Countertop, Backsplash & Inside Side Panels
- 19" x 13-1/2" x 11" Stainless Steel Integral Insulated Ice Bin With Cover
- Dual Plastic Speed Rails (10 Bottle Capacity)
- Open Bottom Shelf & Mid Shelf For Glass Rack Storage
- 5" Heavy Duty Swivel Plate Casters (2 w/ Brakes)
- 2 Towel Rings

Top, Front, Back & Sides Material	Model	Price	Length	Width	Bar Top Width	Wt.	Cu. Ft.
Black Mica	R-8-B	\$14432	95.75"	24.50"	12"	550 lbs.	625



R-8-B Bartender Side Shown

Portable Bar Modifications & Accessories



BK-2



DT-2



SU-80



-7



SU-81

- 7 7-Circuit Cold Plate Sealed into Bottom **\$2466**
Of Ice Bin! Add The Suffix -7 To The Model Number & Add To Cost (Factory Installed Only)
- BK-2 Stainless Steel Speed Rail **145**
- DT-2 Double Tier Stainless Steel Speed Rail **.273**
- SU-80 Continuous Bumper on 3 Sides **1377**
- SU-81 Custom Mica Colors Or S/S Panels **Call Factory**
Custom Colors Include Exterior Finishes Only (Bar Front And Sides. Additional Charge For Bar Top. All Interiors Are Standard Black Finish, Excluding AMS & AMD Series)

See Page 121 For Optional Laminates & Stainless Steel Options



Features:

- Stainless Steel Body, Top & Sides
- Fiberglass Insulation (Excludes Solid Top Tables)
- 1" L.P.S. Drain (Excludes Solid Top Tables)
- Galvanized Legs with Adjustable Bullet Feet

Refrigerated & Hot Well Drop-Ins



Electric & Gas Hot Food Tables



Solid Top Tables



Everyday Buffet Tables



Ice-Cooled Tables



Refrigerated Tables



Sealed Wells

These units allow water to be poured directly into the unit and get heated. Food bins may be used without the use of a Spillage Pan.



Standard Wells

Never pour water directly into these type of units. To use hot water in these units, must use with **Model# SP-A Aluminum Spillage Pans** or **Model # SP-S S/S Spillage Pans**.



Refrigerated

These units are designed to maintain chilled foods at the proper temperature.



Non-Refrigerated

Units are designed to cool foods already chilled using only ice within its insulated bin. There is no refrigeration unit in this equipment.



HOT WELL DROP-INS

Electric Sealed Well Hot Food Drop-In Units

- 304 Stainless Steel Top
- Fiberglass Insulation Between Compartments
- 12" X 20" Die Stamped Pan Openings
- 6" Deep Units

- 1" I.P.S. Drain
- Remote Control Panel
- Infinite Control Knobs
- Indicator Lights



Individual Sealed Well Compartments



DISW-3-120 Shown

STANDARD DROP-IN UNITS

Model #	Price	Length	Width	# of Wells	Cut-Out Size W x L	Volts	Amps	Watts	Approx. Wt.	Cu. Ft.
DISW-1-120	\$3080	15-1/2"	24-1/2"	1	23-1/2" x 15-5/8"	120	9.17	1100	73 lbs.	6
DISW-2-120	4457	30-1/2"	24-1/2"	2	23-1/2" x 29-5/8"	120	12.34	2200	110 lbs.	6
DISW-3-120	5410	44-1/2"	24-1/2"	3	23-1/2" x 43-5/8"	120	27.51	3300	135 lbs.	6
DISW-1-240	3080	15-1/2"	24-1/2"	1	23-1/2" x 15-5/8"	208/240	3.97/4.58	825/1100	73 lbs.	6
DISW-2-240	4457	30-1/2"	24-1/2"	2	23-1/2" x 29-5/8"	208/240	7.94/9.16	1650/2200	110 lbs.	6
DISW-3-240	5410	44-1/2"	24-1/2"	3	23-1/2" x 43-5/8"	208/240	11.91/13.74	2475/3300	135 lbs.	18
DISW-4-240	6426	58-1/2"	24-1/2"	4	23-1/2" x 57-5/8"	208/240	15.88/18.32	3000/4400	180 lbs.	23
DISW-5-240	8368	72-1/2"	24-1/2"	5	23-1/2" x 71-5/8"	208/240	19.85/22.90	4125/5500	208 lbs.	35
DISW-6-240*	9867	86-1/2"	24-1/2"	6	23-1/2" x 85-5/8"	208/240	23.82/27.48	4950/6600	275 lbs.	35

*6-well unit include two sets of control panels

NOTE: Units are not designed to cook or heat frozen or refrigerated foods. Food placed in tables should already be hot, and the table will maintain the proper temperatures



DISLSW-2-120 Shown

SLIMLINE DROP-IN UNITS

Model #	Price	Length	Width	# of Wells	Cut-Out Size W x L	Volts	Amps	Watts	Approx. Wt.	Cu. Ft.
DISLSW-2-120	\$4928	46-1/2"	16-1/2"	2	15-1/4" x 45-1/4"	120	18.34	2200	95 lbs.	11
DISLSW-3-120	5914	68-1/2"	16-1/2"	3	15-1/4" x 67-1/4"	120	27.51	3300	125 lbs.	11
DISLSW-2-240	4928	46-1/2"	16-1/2"	2	15-1/4" x 45-1/4"	208/240	3.94/9.16	1600/2200	95 lbs.	18
DISLSW-3-240	5914	68-1/2"	16-1/2"	3	15-1/4" x 67-1/4"	208/240	11.90/13.34	2475/3300	150 lbs.	18
DISLSW-4-240	8305	90-1/2"	16-1/2"	4	15-1/4" x 89-1/4"	208/240	15.88/18.32	3000/4400	155 lbs.	23

Drop-In Unit Options & Accessories

OPTIONAL NEMA 6" CORD WITH PLUGS AVAILABLE:

Drop-In Units to be hard wired in the field. Please consult the factory for more information.



NEMA 5-15P

SU-P-234 \$223

1 Well, 120-240v Units



NEMA L5-30P

SU-P-231 \$400

4 Well, 120v Units

(6 well unit requires 2 Cords)



NEMA 6-20P

SU-P-232 \$144

2 or 3 Well, 240v Units



NEMA L6-30P

SU-P-233 \$367

4, 5 or 6 Well, 240v Units

Autofill Upgrade

Automatically fills & maintains water level. For DISW, DISLSW, SW & HDSW Series. Requires added cost Manifold Drain Assembly (Except HDSW series). See below.

SU-90 \$2904 Autofill Only



Manifold Drain Assembly

Add The Suffix **-M** To The Model Number And Add Additional Pricing Below.

\$355 Per Well

Filler Faucet

• Hot Water Supply Only
• Requires **-M** Manifold Drain Assembly
• Faucet Location To Be Specified When Ordering

K-49 \$546



Thermostatic Controls

Add The Suffix **-T** To The Model Number And Add Additional Pricing Below.

\$312 Per Well

3-Phase Upgrade

Upgrade 240 volt units to 3 Phase Wiring.

SU-72 \$690 Per Unit

HOT FOOD TABLES

Electric Hot Food Tables



- Stainless Steel Body & Top
- Galvanized Legs, Undershelf & Adjustable Bullet Feet
- Enclosed Base Units Include Stainless Steel Body & Shelf
- Fiberglass Insulation Between Each Compartment
- 8" Wide Poly Cutting Board Shelf - Ships K.D.
- Galvanized Liner. (Optional Stainless Steel Lining upgrade available Model # SU-32 \$177 per well)
- Infinite Control Knobs & Indicator Lights
- Single Phase Wiring (Upgrade to 3 Phase Wiring for 240 Volt Units- Model # SU-72 \$690)



w/ Undershelf
HF-2E-240 Shown

Undershelf

Model #	Price	Length	Width*	# of Wells	Volts	Amps	Watts	NEMA Plug	Wt.	Cu. Ft.
HF-2E-120	\$3070	31-13/16"	30-5/8"	2	120	8.33	1000	5-20P	92 lbs.	28
HF-3E-120	3308	47-1/8"	30-5/8"	3	120	12.50	1500	5-20P	130 lbs.	41
HF-4E-120	4476	62-7/16"	30-5/8"	4	120	16.67	2000	L5-30P	152 lbs.	55
HF-2E-240	3070	31-13/16"	30-5/8"	2	208/240	7.21/8.33	1500/2000	6-20P	92 lbs.	28
HF-3E-240	3308	47-1/8"	30-5/8"	3	208/240	10.82/12.50	2250/3000	6-20P	120 lbs.	41
HF-4E-240	4476	62-7/16"	30-5/8"	4	208/240	14.42/16.67	3000/4000	L6-30P	152 lbs.	55
HF-5E-240	5917	77-3/4"	30-5/8"	5	208/240	18.03/20.84	3750/5000	L6-30P	170 lbs.	67

*Width Includes 8" Cutting Board

See Below For Stainless Steel Legs & Undershelf Upgrade

Enclosed Base

Model #	Price	Length	Width*	# of Wells	Volts	Amps	Watts	NEMA Plug	Wt.	Cu. Ft.
HF-2E-120-BS	\$5943	31-13/16"	30-5/8"	2	120	8.33	1000	5-20P	92 lbs.	28
HF-3E-120-BS	6551	47-1/8"	30-5/8"	3	120	12.50	1500	5-20P	210 lbs.	41
HF-4E-120-BS	7956	62-7/16"	30-5/8"	4	120	16.67	2000	L5-30P	250 lbs.	55
HF-2E-240-BS	5943	31-13/16"	30-5/8"	2	208/240	7.21/8.33	1500/2000	6-20P	92 lbs.	28
HF-3E-240-BS	6551	47-1/8"	30-5/8"	3	208/240	10.82/12.50	2250/3000	6-20P	210 lbs.	41
HF-4E-240-BS	7956	62-7/16"	30-5/8"	4	208/240	14.42/16.67	3000/4000	L6-30P	250 lbs.	55
HF-5E-240-BS	9489	77-3/4"	30-5/8"	5	208/240	18.03/20.84	3750/5000	L6-30P	290 lbs.	67
HF-6E-240-BS	10859	93-1/16"	30-5/8"	5	208/240	18.03/20.84	3750/5000	L6-30P	325 lbs.	88

*Width Includes 8" Cutting Board



Enclosed Base
HF-5E-240-BS Shown with
Optional TA-255P Casters

Enclosed Base w/ Sliding Doors

Model #	Price	Length	Width*	# of Wells	Volts	Amps	Watts	NEMA Plug	Wt.	Cu. Ft.
HF-2E-120-DR	\$6850	31-13/16"	30-5/8"	2	120	8.33	1000	5-20P	127 lbs.	28
HF-3E-120-DR	7674	47-1/8"	30-5/8"	3	120	12.50	1500	5-20P	155 lbs.	41
HF-4E-120-DR	9072	62-7/16"	30-5/8"	4	120	16.67	2000	L5-30P	197 lbs.	55
HF-2E-240-DR	6850	31-13/16"	30-5/8"	2	208/240	7.21/8.33	1500/2000	6-20P	127 lbs.	28
HF-3E-240-DR	7674	47-1/8"	30-5/8"	3	208/240	10.82/12.50	2250/3000	6-20P	155 lbs.	41
HF-4E-240-DR	9072	62-7/16"	30-5/8"	4	208/240	14.42/16.67	3000/4000	L6-30P	197 lbs.	55
HF-5E-240-DR	10551	77-3/4"	30-5/8"	5	208/240	18.03/20.84	3750/5000	L6-30P	215 lbs.	67
HF-6E-240-DR	12038	93-1/16"	30-5/8"	5	208/240	18.03/20.84	3750/5000	L6-30P	250 lbs.	88

*Width Includes 8" Cutting Board



w/ Sliding Doors
HF-5E-240-DR Shown

NOTE: Units are not designed to cook or heat frozen or refrigerated foods. Food placed in tables should already be hot, and the table will maintain the proper temperatures

Food Table Modifications & Accessories

For Our Full Line Of Hot Food Table Modifications, Accessories & Replacement Parts, See Page 137-140

Stainless Steel Legs & Undershelf Upgrade			
2 Wells	3 Wells	4 Wells	5 Wells
SU-23A \$1080	SU-23B \$1117	SU-23C \$1185	SU-23D \$1332

Galvanized Undershelf For Food Tables			
2 Wells	3 Wells	4 Wells	5 Wells
SU-30-UG2 \$373	SU-30-UG3 \$474	SU-30-UG4 \$608	SU-UG5 \$686

- SU-255** Add Casters to Food Units w/Undershelf (Includes 4 - 5" Swivel Casters, 2 w/ Brakes & Legs That maintain height) **\$646 Set of 4**
- TA-255P** Add Casters to Enclosed Base Food Units (Includes 4 - 5" Bolted Swivel Casters, 2 w/ Brakes) **934 Set of 4**
- SU-SG** Replacement Galvanized legs with Bullet Foot For Hot/Ice Cooled Table with Undershelf (HF, SM, HB, STU or CPU Series) **101 ea.**
- TCB-OMIT** Remove Poly Cutting Board & Shelf **-227 ea.**
- CB-OMIT** Remove Poly Cutting Board Only **-113 ea.**
- SU-19** Prepare Hot Tables To Be Locked Together (One Charge For Each Table To Be Interlocked) **\$791 ea.**
- SU-32** Upgrade to a Stainless Steel Lining (For Electric Units. Excludes Sealed Hot Well Units) **177 per well**
- SP-A** Aluminum Spillage Pan **183 ea.**
- SP-S** Stainless Steel Spillage Pan **321 ea.**
- SU-72** Upgrade 240 volt units to 3-Phase Wiring **690 ea.**

HOT FOOD TABLES

Electric Sealed Well Hot Food Tables



- Stainless Steel Body & Top
- Galvanized Legs, Undershelf & Adjustable Bulter Feet
- Enclosed Base Units Include Stainless Steel Body & Shelf
- Stainless Steel Lining
- Fiberglass Insulation Between Each Compartment
- Drains With Gate Valves Per Well
- 8" Wide Poly Cutting Board Shelf - Ships K.D.
- 8 Ft. Electric Cord w/ Plug Included
- Infinite Control Knobs & Indicator Lights
- Single Phase Wiring (Upgrade to 3 Phase Wiring for 240 Volt Units - Model # SU-72 \$690)



Individual Sealed Well Compartments

Undershelf

Model #	Price	Length	Width*	# of Wells	Volts	Amps	Watts	NEMA Plug	WL.	Cu. Ft.
SW-2E-120	\$3696	31-13/16"	30-5/8"	2	120	10.67	1280	5-20P	92 lbs.	28
SW-3E-120	4473	47-1/8"	30-5/8"	3	120	16	1920	5-20P	135 lbs.	55
SW-4E-120	6255	62-7/16"	30-5/8"	4	120	21.33	2560	L5-30P	230 lbs.	55
SW-2E-240	3696	31-13/16"	30-5/8"	2	208/240	7.94/9.16	1650/2200	6-20P	92 lbs.	28
SW-3E-240	4473	47-1/8"	30-5/8"	3	208/240	11.91/13.74	2475/3300	6-20P	135 lbs.	41
SW-4E-240	6307	62-7/16"	30-5/8"	4	208/240	15.88/18.32	3300/4400	L6-30P	197 lbs.	55
SW-5E-240	7772	77-3/4"	30-5/8"	5	208/240	19.85/22.90	4125/5500	L6-30P	215 lbs.	67

*Width Includes 8" Cutting Board

See Below For Stainless Steel Legs & Undershelf Upgrade



w/ Undershelf
SW-3E-120 Shown

Enclosed Base

Model #	Price	Length	Width*	# of Wells	Volts	Amps	Watts	NEMA Plug	WL.	Cu. Ft.
SW-2E-120-BS	\$6920	31-13/16"	30-5/8"	2	120	10.67	1280	5-20P	127 lbs.	28
SW-3E-120-BS	7949	47-1/8"	30-5/8"	3	120	16	1920	5-20P	155 lbs.	41
SW-4E-120-BS	9770	62-7/16"	30-5/8"	4	120	21.33	2560	L5-30P	197 lbs.	54
SW-2E-240-BS	6920	31-13/16"	30-5/8"	2	208/240	7.94/9.16	1650/2200	6-20P	127 lbs.	28
SW-3E-240-BS	7949	47-1/8"	30-5/8"	3	208/240	11.91/13.74	2475/3300	6-20P	155 lbs.	41
SW-4E-240-BS	9770	62-7/16"	30-5/8"	4	208/240	15.88/18.32	3300/4400	L6-30P	197 lbs.	55
SW-5E-240-BS	11517	77-3/4"	30-5/8"	5	208/240	19.85/22.90	4125/5500	L6-30P	220 lbs.	67
SW-6E-240-BS	12502	93-1/16"	30-5/8"	6	208/240	23.82/27.48	4850/6600	L6-30P	255 lbs.	88

*Width Includes 8" Cutting Board



Enclosed Base
SW-5E-240-BS Shown
with Optional TA-255P Casters

Enclosed Base w/ Sliding Doors

Model #	Price	Length	Width*	# of Wells	Volts	Amps	Watts	NEMA Plug	WL.	Cu. Ft.
SW-2E-120-DR	\$7680	31-13/16"	30-5/8"	2	120	10.67	1280	5-20P	145 lbs.	28
SW-3E-120-DR	9395	47-1/8"	30-5/8"	3	120	16	1920	5-20P	157 lbs.	41
SW-4E-120-DR	11543	62-7/16"	30-5/8"	4	120	21.33	2560	L5-30P	187 lbs.	54
SW-2E-240-DR	7680	31-13/16"	30-5/8"	2	208/240	7.94/9.16	1650/2200	6-20P	145 lbs.	28
SW-3E-240-DR	9395	47-1/8"	30-5/8"	3	208/240	11.91/13.74	2475/3300	6-20P	157 lbs.	41
SW-4E-240-DR	11543	62-7/16"	30-5/8"	4	208/240	15.88/18.32	3300/4400	L6-30P	200 lbs.	54
SW-5E-240-DR	12475	77-3/4"	30-5/8"	5	208/240	19.85/22.90	4125/5500	L6-30P	281 lbs.	67
SW-6E-240-DR	13654	93-1/16"	30-5/8"	6	208/240	23.82/27.48	4850/6600	L6-30P	316 lbs.	88

*Width Includes 8" Cutting Board



w/ Sliding Doors
SW-5E-240-DR Shown

NOTE: Units are not designed to cook or heat frozen or refrigerated foods. Food placed in tables should already be hot, and the table will maintain the proper temperatures

Food Table Accessories & Modifications

For Our Full Line Of Hot Food Table Modifications, Accessories & Replacement Parts, See Page 137-140

Stainless Steel Legs & Undershelf Upgrade				Galvanized Undershelf For Food Tables			
2 Wells	3 Wells	4 Wells	5 Wells	2 Wells	3 Wells	4 Wells	5 Wells
SU-23A \$1080	SU-23B \$1117	SU-23C \$1185	SU-23D \$1332	SU-30-UG2 \$373	SU-30-UG3 \$474	SU-30-UG4 \$608	SU-UG5 \$686
-T Thermostatic Control (Per Well)			\$312 ea.	SU-32G Upgrade to a Stainless Steel Lining (For Gas Units. Excludes Wetbath Units)			\$168 per well
-M Manifold Drains (Per Well)			355 ea.	SU-90 Automatically fills & maintains water level. For DGSW, DISLSW, SW & HDSW Series. Requires added cost Manifold Drain Assembly (Except HDSW series). See page 126.			2904 Autofill Only
SP-A Aluminum Spillage Pan			183 ea.	K-49 Filler Faucet for Hot Tables (Hot water supply only. Requires -M Manifold Drain & SU-15 Prepare for Filler Faucet Provision)			546 ea.
SP-S Stainless Steel Spillage Pan			321 ea.	SU-15 Prepare Hot food Table For Filler Faucet (For Gas Units. Excludes Wetbath Units)			1064 ea.
SU-255 Add Casters to Food Units w/Undershelf (Includes 4 - 5" Swivel Casters, 2 w/ Brakes & Legs that maintain height)			646 Set of 4	TCB-OMIT Remove Poly Cutting Board & Shelf			-227 ea.
TA-255P Add Casters to Enclosed Base Food Units (Includes 4 - 5" Bolted Swivel Casters, 2 w/ Brakes)			934 Set of 4	CB-OMIT Remove Poly Cutting Board Only			-113 ea.
SU-5G Replacement Galvanized Legs with Bulter Foot For Hot/Cooled Table with Undershelf (HP, SW, WB, STU or CPU Series)			101 ea.				



HOT FOOD TABLES

Gas Powered Hot Food Tables

For Use with Optional Spillage Pans

- These Units Are Designed For Dry Operation Only.
- Stainless Steel Body & Top
- Galvanized Legs, Undershelf & Adjustable Bullet Feet
- Enclosed Base Units Include Stainless Steel Body & Shelf
- Galvanized Liner. (Optional Stainless Steel Liner upgrade available Model # SU-32G \$168 per well)
- 3500 BTU'S Per burner

- Fiberglass Insulation Between Each Compartment
- 8" Wide Poly Cutting Board Shelf - Ships K.D.
- Pilot Indicator Openings
- 1/2" Female NPT Connection To Regulator
- Infinite Control Knobs

Available For Natural Gas (NAT) Or Bottled Gas (LP)

Undershelf

Model #	Price	Length	Width*	# of Wells	Approx. Weight	Approx. Cu. Ft.
HF-2G-NAT or LP	\$3172	31-13/16"	30-5/8"	2	92 lbs.	28
HF-3G-NAT or LP	3531	47-1/8"	30-5/8"	3	130 lbs.	41
HF-4G-NAT or LP	4288	62-7/16"	30-5/8"	4	165 lbs.	55
HF-5G-NAT or LP	5279	77-3/4"	30-5/8"	5	170 lbs.	67

*Width Includes 8" Cutting Board

For Stainless Steel Legs & Undershelf Upgrade See Page 128



w/ Undershelf
HF-3G-NAT Shown

Enclosed Base

Model #	Price	Length	Width*	# of Wells	Approx. Weight	Approx. Cu. Ft.
HF-2G-NAT or LP-BS	\$5503	31-13/16"	30-5/8"	2	117 lbs.	28
HF-3G-NAT or LP-BS	5779	47-1/8"	30-5/8"	3	145 lbs.	41
HF-4G-NAT or LP-BS	7792	62-7/16"	30-5/8"	4	205 lbs.	55
HF-5G-NAT or LP-BS	8922	77-3/4"	30-5/8"	5	250 lbs.	67

*Width Includes 8" Cutting Board



Enclosed Base
HF-5G-LP-BS Shown
with Optional TA-255P Casters

SU-19 Prepare Hot Tables to be Locked Together \$791 ea.

(One Charge For Each Table To Be Interlocked)

NOTE: External pressure regulator is required. 4" WC pressure in for Natural Gas and 10" WC pressure in for LP.

NOTE: Units are not designed to cook or heat frozen or refrigerated foods. Food placed in tables should already be hot, and the table will maintain the proper temperatures

Sleek Shields™

Protected By: Patent No. US 9,010,883 B2

Self-Serve Style

- 18" Standard Height (Top of Table To Top)
- 1" Stainless Steel Tubing Posts (1 5/8" Posts Also Available)
- Includes Two 18" W x 16 3/8" H Glass Side Panels
- 1/4" Thick Heat-Tempered Glass Front & Sides
- Shipped KD

GLASS FOOD SHIELDS

Mounts To Top Of Hot/Cold Food Table



Includes TA-47 Mounting Brackets For In-Field Installation



Chamber Lock™ Allows Front Glass To Lock In Place At 15" Intervals



NSG-15-4WELL Shown

15" Wide Stainless Steel Shelf			15" Wide w/ Glass Top			Fits # of Bowls	Approx. Wt.	Approx. Cubes
Model #	Price	O.A. Size L x W x H	Model #	Price	O.A. Size L x W x H			
NSG-15-2WELL	\$4826	33 11/16" x 19 3/4" x 18 3/4"	GSG-15-2WELL	\$5790	33 11/16" x 19 3/4" x 18"	Fits 2-Well Unit	109 lbs.	15
NSG-15-3WELL	5024	49" x 19 3/4" x 18 3/4"	GSG-15-3WELL	6008	49" x 19 3/4" x 18"	Fits 3-Well Unit	143 lbs.	22
NSG-15-4WELL*	5881	64 5/16" x 19 3/4" x 18 3/4"	GSG-15-4WELL*	6392	64 5/16" x 19 3/4" x 18"	Fits 4-Well Unit	186 lbs.	29
NSG-15-5WELL**	6423	79 5/8" x 19 3/4" x 18 3/4"	Not Available		Not Available	Fits 5-Well Unit	215 lbs.	38
NSG-15-6WELL**	7114	94 15/16" x 19 3/4" x 18 3/4"	Not Available		Not Available	Fits 6-Well Unit	247 lbs.	47

GSG Series Food Shields are slightly longer than the table they rest on. They will extend about 7/8" on either end
*3/8" Thick Heat-Tempered Glass Required For Front Glass **Requires a Single Center Post (Factory Print Included)

For Full Line Of Glass Top Food Shields & Food Table Accessories, See Page 137-143.

HOT FOOD TABLES

Gas Powered Wetbath Tables



- Stainless Steel Body & Top
- Galvanized Legs, Undersheff & Adjustable Bullet Feet
- Enclosed Base Units Include Stainless Steel Body & Sheff
- Stainless Steel Liner
- Stainless Steel Dish Shelf
- 8" Wide Poly Cutting Board Shelf - Ships K.O.

- 1/2" Female NPT Connection To Regulator
- Pilot Indicator Openings
- Infinite Control Knobs
- **2 & 3 Comp:** 15,000 BTU's
- **4 & 5 Comp:** 25,000 BTU's

Filler Faucet K-49 \$546



- Hot Water Supply Only
- Requires -M Manifold Drain Assembly & **SU-15** Filler Faucet Provision
- Faucet Location To Be Specified When Ordering

Available For Natural Gas (NAT) Or Bottled Gas (LP)

Undersheff

Model #	Price	Length	Width*	# of Wells	Approx. Weight	Approx. Cu. Ft.
WB-2G-NAT or LP	\$3964	31-13/16"	30-5/8"	2	96 lbs.	28
WB-3G-NAT or LP	4335	47-1/8"	30-5/8"	3	130 lbs.	41
WB-4G-NAT or LP	5008	62-7/16"	30-5/8"	4	157 lbs.	55
WB-5G-NAT or LP	5891	77-3/4"	30-5/8"	5	176 lbs.	67

See Below For Stainless Steel Legs & Undersheff Upgrade



Enclosed Base

Model #	Price	Length	Width*	# of Wells	Approx. Weight	Approx. Cu. Ft.
WB-2G-NAT or LP-BS	\$6326	31-13/16"	30-5/8"	2	145 lbs.	28
WB-3G-NAT or LP-BS	6795	47-1/8"	30-5/8"	3	175 lbs.	41
WB-4G-NAT or LP-BS	7593	62-7/16"	30-5/8"	4	225 lbs.	55
WB-5G-NAT or LP-BS	8493	77-3/4"	30-5/8"	5	296 lbs.	67

*Width Includes 8" Cutting Board



NOTE: External pressure regulator is required. 4" WC pressure in for Natural Gas and 10" WC pressure in for LP.

NOTE: Units are not designed to cook or heat frozen or refrigerated foods. Food placed in tables should already be hot, and the table will maintain the proper temperatures

Food Table Modifications & Accessories

For Our Full Line Of Hot Food Table Modifications, Accessories & Replacement Parts, See Page 137-140

Galvanized Undersheff For Food Tables			
2 Wells	3 Wells	4 Wells	5 Wells
SU-30-UG2 \$373	SU-30-UG3 \$474	SU-30-UG4 \$608	SU-UG5 \$686



10" Wide Serving Shelf with Built-In Food Shield

- SU-15 Prepare Hot Food Table for Filler Faucet (Faucet Not Included. Stationary Models Only) **\$1064 ea.**
- SU-19 Prepare Hot Tables To Be Locked Together **791 ea.**
(One Charge For Each Table To Be Interlocked)
- SU-25S Add Casters to Food Units w/Undersheff (Includes 4 - 5" Swivel Casters, 2 w/ Brakes & Legs that maintain height) **646 Set of 4**
- TA-25SP Add Casters to Enclosed Base Food Units (Includes 4 - 5" Bolted Swivel Casters, 2 w/ Brakes) **934 Set of 4**
- SU-5G Replacement Galvanized Legs with Bullet Foot For Hot/Ice Cooled Table with Undersheff (NF, SW, WB, STU or CPU Series) **101 ea.**
- SP-A Aluminum Spillage Pan **183 ea.**
- SP-S Stainless Steel Spillage Pan **321 ea.**
- TCB-OMIT Remove Poly Cutting Board & Sheff **-227 ea.**
- CB-OMIT Remove Poly Cutting Board Only **-113 ea.**

Model	Price	Length	Approx. Wt.	Cu. Ft.
TSS-2	\$1503	31-13/16"	15 lbs.	2
TSS-3	1711	47-1/8"	17 lbs.	3
TSS-4	1866	62-7/16"	19 lbs.	4
TSS-5	2003	77-3/4"	21 lbs.	4
TSS-6	2393	93-1/16"	33 lbs.	5

Acrylic Side Panel for Serving Shelf

Add side panels to meet additional NSF requirements. (1 panel per side)

TSP-1 **\$380 One End**
TSP-2 **\$779 Two Ends**

Field Installation Available



Sleek Shields™ Are Also Available For Hot & Cold Food Tables. See Pages 138 For Details.

SOLID FOOD TABLES

Solid Top Tables

- Stainless Steel Body & Top
- Galvanized Legs, Undersheff & Adjustable Bullet Feet
- Enclosed Base Units Include Stainless Steel Body & Shelf
- 8" Wide Poly Cutting Board Shelf - Ships K.D.



w/Undersheff
STU-3 Shown

Undersheff

Model #	Price	Length	Width*	Wt.	Cu. Ft.
STU-2	\$1983	31-13/16"	30-5/8"	90 lbs.	12
STU-3	2308	47-1/8"	30-5/8"	118 lbs.	17
STU-4	2735	62-7/16"	30-5/8"	150 lbs.	23
STU-5	3447	77-3/4"	30-5/8"	168 lbs.	41

*Width Includes 8" Cutting Board

For Stainless Steel Legs & Undersheff Upgrade See Page 128



Enclosed Base
STU-3-BS Shown

Enclosed Base

Model #	Price	Length	Width*	Wt.	Cu. Ft.
STU-2-BS	\$6427	31-13/16"	30-5/8"	115 lbs.	20
STU-3-BS	6783	47-1/8"	30-5/8"	143 lbs.	30
STU-4-BS	8040	62-7/16"	30-5/8"	185 lbs.	46
STU-5-BS	8966	77-3/4"	30-5/8"	203 lbs.	56

*Width Includes 8" Cutting Board

w/ Doors

Model #	Price	Length	Width*	Wt.	Cu. Ft.
STU-2-DR	\$6962	31-13/16"	30-5/8"	125 lbs.	26
STU-3-DR	9403	47-1/8"	30-5/8"	153 lbs.	36
STU-4-DR	8769	62-7/16"	30-5/8"	195 lbs.	48
STU-5-DR	10249	77-3/4"	30-5/8"	213 lbs.	56

*Width Includes 8" Cutting Board



w/ Doors
STU-5-DR Shown

- SU-19 Prepare Hot Tables to be Locked Together (One Charge For Each Table To Be Interlocked) **\$791 ea.**
- TCB-OMIT Remove Poly Cutting Board & Shelf **-227 ea.**
- CB-OMIT Remove Poly Cutting Board Only **-113 ea.**

Food Table Overshelves

For Our Full Line Of Hot Food Table Modifications, Accessories & Replacement Parts, See Page 137-140



Single Overshelves



Double Overshelves

12" WIDE				18" WIDE				12" WIDE				18" WIDE					
Model	Price	Approx. Wt.		Model	Price	Length	Approx. Wt.	Cu. Ft.	Model	Price	Approx. Wt.		Model	Price	Length	Approx. Wt.	Cu. Ft.
STOS-2	\$1208	18 lbs.		STOS-2-18	\$1536	31-13/16"	20 lbs.	3	TOS-2	\$2191	32 lbs.		TOS-2-18	\$2606	31-13/16"	35 lbs.	3
STOS-3	1372	21 lbs.		STOS-3-18	1653	47-1/8"	23 lbs.	4	TOS-3	2558	38 lbs.		TOS-3-18	3007	47-1/8"	41 lbs.	4
STOS-4	1544	24 lbs.		STOS-4-18	1790	62-7/16"	26 lbs.	5	TOS-4	2924	44 lbs.		TOS-4-18	3435	62-7/16"	47 lbs.	5
STOS-5	1672	27 lbs.		STOS-5-18	1954	77-3/4"	30 lbs.	6	TOS-5	3287	49 lbs.		TOS-5-18	3853	77-3/4"	53 lbs.	6
STOS-6	2039	33 lbs.		STOS-6-18	2383	93-1/8"	35 lbs.	6	TOS-6	4012	56 lbs.		TOS-6-18	4703	93-1/8"	61 lbs.	6

COLD WELL DROP-INS

Drop-In Cold Pan Units

ICE-COOLED DROP-IN COLD PAN UNITS

- 304 Stainless Steel Top
- 9" Deep Ice Bin With Fiberglass Insulation

- Black Molding with Thermal Breaker
- 1" I.P.S. Drain



Slimline
DISLCP-3 Shown



Standard
DICP-2 Shown

	Model #	Price	Length	Width	Cut-Out Size	Ice Capacity	Approx. Wt.	Cu. Ft.
SLIMLINE	DISLCP-2	\$3420	49 5/8"	18-5/8"	17 3/8" x 48-3/8"	93	168 lbs.	11
	DISLCP-3	4129	71 1/4"	18-5/8"	17 3/8" x 70"	141	178 lbs.	18
	DISLCP-4	4715	92 7/8"	18-5/8"	17 3/8" x 91 5/8"	186	215 lbs.	23
STANDARD	DICP-1	2374	18-13/16"	26 3/4"	25 1/2" x 18 5/8"	45	129 lbs.	6
	DICP-2	2815	34-1/8"	26 3/4"	25 1/2" x 32 1/8"	93	162 lbs.	10
	DICP-3	3226	49-7/16"	26 3/4"	25 1/2" x 45 5/8"	141	165 lbs.	14
	DICP-4	4014	64-3/4"	26 3/4"	25 1/2" x 59 1/8"	188	199 lbs.	18
	DICP-5	4633	80-1/8"	26 3/4"	25 1/2" x 72 5/8"	236	240 lbs.	23
	DICP-6	5102	95-3/8"	26 3/4"	25 1/2" x 86 1/8"	284	268 lbs.	27

Optional Adapter Rails & Bars

DICP SERIES			DISLCP SERIES			Description
Model #	Fits Model:	Price	Model #	Fits Model:	Price	
SU-P-501	DICP-1	\$191				Two Left To Right Rails & Two Front-To-Back Supports. Includes Mounting Screws.
SU-P-502	DICP-2	\$286	SU-P-512	DISLCP-2	\$286	Two Left To Right Rails & Three Front-To-Back Supports. Includes Mounting Screws.
SU-P-503	DICP-3	\$382	SU-P-513	DISLCP-3	\$382	Two Left To Right Rails & Four Front-To-Back Supports. Includes Mounting Screws.
SU-P-504	DICP-4	\$476	SU-P-514	DISLCP-4	\$586	Two Left To Right Rails & Five Front-To-Back Supports. Includes Mounting Screws.
SU-P-505	DICP-5	\$572				Two Left To Right Rails & Six Front-To-Back Supports. Includes Mounting Screws.
SU-P-506	DICP-6	\$668				Two Left To Right Rails & Seven Front-To-Back Supports. Includes Mounting Screws.

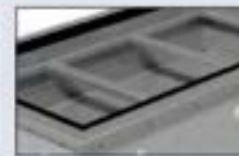

Left To Right Rails & Front To Back Supports Shown Above

Horizontal Adapter Bars
For Small Pan Sizes

12" x 1"
Model # SU-45A

Works With Required Rail Kits
(See Grid Above)



REFRIGERATED DROP-IN COLD PAN UNITS

- 304 Stainless Steel Top
- 9" Deep Ice Bin With Fiberglass Insulation
- Full Insulation Galvanized Outer Jacket
- Black Molding with Thermal Breaker
- High Cooling Capacity
- Sight Glass To Ensure Properly Charges System
- Low Running Current

- 1" I.P.S. Drain
- Precision Thermostat For Exact Temperature Control
- Includes Adapter Bars For 12" X 20" Food Pans (Pans not included)
- 8 Ft. Cord & Plug Included



Slimline
DISLRCP-2 Shown



Standard
DIRCP-3 Shown

	Model #	Price	Length	Width	Cut-Out Size	# of Wells	Refrigerant	Approx. Wt.	Cu. Ft.
SLIMLINE	DISLRCP-2	\$9120	49-5/8"	18-5/8"	17-1/8" x 48-3/8"	2	R404-A	205 lbs.	25
	DISLRCP-3	10244	71-1/4"	18-5/8"	15-3/8" x 70"	3	R404-A	257 lbs.	31
	DISLRCP-4	11384	92-7/8"	18-5/8"	17-3/8" x 91-5/8"	4	R404-A	325 lbs.	46
STANDARD	DIRCP-1	6917	20"	26-3/4"	25-1/2" x 18-5/8"	1	R404-A	163 lbs.	14
	DIRCP-2	7392	33-1/2"	26-3/4"	25-1/2" x 32-1/8"	2	R404-A	205 lbs.	22
	DIRCP-3	8117	47"	26-3/4"	25-1/2" x 45-5/8"	3	R404-A	257 lbs.	31
	DIRCP-4	9041	60-1/2"	26-3/4"	25-1/2" x 59-1/8"	4	R404-A	325 lbs.	39
	DIRCP-5	10593	74"	26-3/4"	25-1/2" x 72-5/8"	5	R404-A	365 lbs.	47
	DIRCP-6	11356	87-1/2"	26-3/4"	25-1/2" x 86-1/8"	6	R404-A	398 lbs.	55

SU-71 5 Year Extended Parts Warranty on Refrigeration Unit **\$710 Per Unit**
(Available for Refrigerated Tables & Drop-Ins. See Back Inside Cover For Full Details)



SU-P-234 - 8' Cord with NEMA 5-15P plug Included

NOTE: Units are not designed to cool foods originally warm. Food should already be chilled to maintain the proper temperatures

130 **WARNING:** Refrigerated Equipment on this page may expose you to chemicals, including Ethanes, that are known to the State of California to cause cancer or birth defects or other reproductive harm. For more info, visit www.p65warnings.ca.gov



COLD FOOD TABLES

Standard Ice-Cooled Tables

- 304 Stainless Steel Body & Top
- Galvanized Legs, Undershelf & Adjustable Bullet Feet
- Enclosed Base Units Include Stainless Steel Body & Shelf
- Fiberglass Insulation
- 1" L.P.S. Drain
- 8" Wide Poly Cutting Board Shelf - Ships K.D.

Undershelf

Model #	Price	Length	Width*	WL	Cu. Ft.
CPU-2	\$2244	31-13/16"	30-5/8"	90 lbs.	12
CPU-3	2904	47-1/8"	30-5/8"	118 lbs.	18
CPU-4	3518	62-7/16"	30-5/8"	150 lbs.	23
CPU-5	4135	77-3/4"	30-5/8"	168 lbs.	29

*Width Includes 8" Cutting Board

Stainless Steel Legs & Undershelf Upgrade

2 Wells	3 Wells	4 Wells	5 Wells
SU-23A \$1080	SU-23B \$1117	SU-23C \$1185	SU-23D \$1332

SU-5G Replacement Galvanized Legs with Bullet Foot For Hot/Ice Cooled Table with Undershelf (w/ SW, WB, STU or CPU Series) \$101 ea.

w/ Undershelf
CPU-3 Shown



Optional Adapter Bars

12" x 1"	20" x 3"
Model # SU-45A \$80 ea.	Model # SU-45B \$90 ea.

Enclosed Base

Model #	Price	Length	Width*	WL	Cu. Ft.
CPU-2-BS	\$5575	31-13/16"	30-5/8"	115 lbs.	18
CPU-3-BS	6610	47-1/8"	30-5/8"	143 lbs.	24
CPU-4-BS	7820	62-7/16"	30-5/8"	227 lbs.	44
CPU-5-BS	8259	77-3/4"	30-5/8"	203 lbs.	54

*Width Includes 8" Cutting Board

w/ Doors

Model #	Price	Length	Width*	WL	Cu. Ft.
CPU-2-DR	\$5874	31-13/16"	30-5/8"	129 lbs.	24
CPU-3-DR	7042	47-1/8"	30-5/8"	153 lbs.	34
CPU-4-DR	8440	62-7/16"	30-5/8"	195 lbs.	44
CPU-5-DR	8983	77-3/4"	30-5/8"	213 lbs.	54

*Width Includes 8" Cutting Board

Enclosed Base
CPU-5-BS Shown
with Optional
Caster Kit



W/ Doors
CPU-5-DR
Shown



NOTE: Units are not designed to cool foods originally warm. Food should already be chilled to maintain the proper temperatures



CONNECT IT!
Prepare Tables To Be Locked Together While Keeping Them Lined Up! (One Charge For Each Table To Be Interlocked)
SU-19 \$791 per table

Sleek Shields™
Protected By: Patent No. US 9,010,883 B2

GLASS FOOD SHIELDS

Mounts To Top Of Hot/Cold Food Table

Self-Serve Style

- 18" Standard Height (Top of Table to Top)
- 1" Stainless Steel Tubing Posts (1 5/8" Posts Also Available)
- Includes Two 18" W x 16 3/8" H Glass Side Panels
- 1/4" Thick Heat-Tempered Glass Front & Sides
- Shipped KD



Includes TA-47
Mounting Brackets
For In-Field Installation



Chamber Lock™
Allows Front Glass To Lock
In Place At 15" Intervals



NSG-15-4WELL Shown

15" Wide Stainless Steel Shelf			15" Wide w/ Glass Top			Fits # of Wells	Approx. WL	Approx. Cubes
Model #	Price	O.A. Size L x W x H	Model #	Price	O.A. Size L x W x H			
NSG-15-2WELL	\$4826	33 11/16" x 19 3/4" x 18 3/4"	GSG-15-2WELL	\$5790	33 11/16" x 19 3/4" x 18"	Fits 2-Well Unit	109 lbs.	15
NSG-15-3WELL	5024	49" x 19 3/4" x 18 3/4"	GSG-15-3WELL	6008	49" x 19 3/4" x 18"	Fits 3-Well Unit	143 lbs.	22
NSG-15-4WELL*	5881	64 5/16" x 19 3/4" x 18 3/4"	GSG-15-4WELL*	6392	64 5/16" x 19 3/4" x 18"	Fits 4-Well Unit	186 lbs.	29
NSG-15-5WELL**	6423	79 5/8" x 19 3/4" x 18 3/4"	Not Available	Not Available	Not Available	Fits 5-Well Unit	215 lbs.	38
NSG-15-6WELL**	7114	94 15/16" x 19 3/4" x 18 3/4"	Not Available	Not Available	Not Available	Fits 6-Well Unit	247 lbs.	47

GSG Series Food Shields are slightly longer than the table they rest on. They will extend about 7/8" on either end
*3/8" Thick Heat-Tempered Glass Required For Front Glass **Requires a Single Center Post (Factory Print Included)

For Full Line Of Glass Top Food Shields & Food Table Accessories, See Page 137-140.

COLD FOOD TABLES

Mechanically Assisted Cold Pan Tables



REFRIGERATED COLD PAN TABLES

- 304 Stainless Steel Body, Top and Legs
- Adjustable Bullet Feet
- Heavy Duty Cabinet Base
- 8" Wide Poly Cutting Board Shelf - Ships K.D.
- 1" I.P.S. Drain
- Precision Thermostat For Exact Temperature Control
- High Cooling Capacity
- Sight Glass To Ensure Properly Charges System
- Low Running Current
- 8 Ft. Electric Cord w/ Plug Included
- Includes Adapter Bars For Optional spillage Pans

Enclosed Base

Model #	Price	Length	Width*	Refrigerant	Wt.	Cu. Ft.
MACP-2-BS	\$13745	31-3/16"	30-5/8"	R404-A	230 lbs.	39
MACP-3-BS	15517	47-1/8"	30-5/8"	R404-A	256 lbs.	56
MACP-4-BS	16770	62-7/16"	30-5/8"	R404-A	380 lbs.	73
MACP-5-BS	18297	77-3/4"	30-5/8"	R404-A	465 lbs.	90

*Width Includes 8" Cutting Board



SU-P-234 - 8' Cord with NEMA 5-15P plug Included



Enclosed Base
MACP-3-BS Shown



Sliding Doors
MACP-3-DR Shown

w/ Sliding Doors

Model #	Price	Length	Width*	Refrigerant	Wt.	Cu. Ft.
MACP-3-DR	\$16105	47-1/8"	30-5/8"	R404-A	385 lbs.	41
MACP-4-DR	18648	62-7/16"	30-5/8"	R404-A	420 lbs.	73
MACP-5-DR	20418	77-3/4"	30-5/8"	R404-A	505 lbs.	90

*Width Includes 8" Cutting Board



Cold Pan Table Covers

- Stainless Steel
- Plastic Handles
- Piano Hinge(s)
- Fits CPU, DSCP
MACP & BMACP
Units

Model #	Price	Length	Wt.	Cu. Ft.
HC-2	\$553	28-3/16"	12 lbs.	3
HC-3	827	43-7/8"	16 lbs.	4
HC-4	905	59-3/16"	20 lbs.	5
HC-5	1051	74-1/2"	24 lbs.	6

SU-71 5 Year Extended Parts Warranty on Refrigeration Unit **\$682 Per Unit**
(Available for Refrigerated Tables & Drop-Ins. See Back Inside Cover For Full Details)

NOTE: Units are not designed to cool foods originally warm. Food should already be chilled to maintain the proper temperatures

WARNING: Refrigerated Equipment on this page may expose you to chemicals, including Ethanes, that are known to the State of California to cause cancer or birth defects or other reproductive harm. For more info, visit www.p65warnings.ca.gov

Food Table Shelving

For Our Full Line Of Hot Food Table Modifications, Accessories & Replacement Parts, See Page 139-142



Single Overshelves

12" WIDE				18" WIDE				
Model	Price	Approx Wt.		Model	Price	Length	Approx Wt.	Cu. Ft.
STOS-2	\$1208	18 lbs.		STOS-2-18	\$1536	31-13/16"	20 lbs.	3
STOS-3	1372	21 lbs.		STOS-3-18	1653	47-1/8"	23 lbs.	4
STOS-4	1544	24 lbs.		STOS-4-18	1790	62-7/16"	26 lbs.	5
STOS-5	1672	27 lbs.		STOS-5-18	1954	77-3/4"	30 lbs.	6
STOS-6	2039	33 lbs.		STOS-6-18	2383	93-1/16"	35 lbs.	6

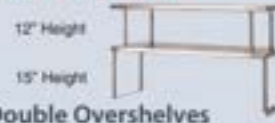

Double Overshelves

12" WIDE				18" WIDE				
Model	Price	Approx Wt.		Model	Price	Length	Approx Wt.	Cu. Ft.
TOS-2	\$2191	32 lbs.		TOS-2-18	\$2606	31-13/16"	35 lbs.	3
TOS-3	2558	36 lbs.		TOS-3-18	3007	47-1/8"	41 lbs.	4
TOS-4	2924	44 lbs.		TOS-4-18	3435	62-7/16"	47 lbs.	5
TOS-5	3287	49 lbs.		TOS-5-18	3853	77-3/4"	53 lbs.	6
TOS-6	4012	56 lbs.		TOS-6-18	4703	93-1/16"	61 lbs.	6

Food Table Accessories

- SU-255 Add Casters to Food Units w/Undershelf (Includes 4 - 5" Swivel Casters, 2 w/ Brakes & Legs that maintain height) **\$646 Set of 4**
- SU-25 Add Casters to Food Units w/Undershelf (For Units Built Before October 2015. Includes 4 - 5" Swivel Casters, 2 w/ Brakes.) **594 Set of 4**
- TA-25 Replacement Casters For Undershelf Units (For Units Built After October 2015. Includes 4 - 5" Swivel Casters, 2 w/ Brakes.) **594 Set of 4**
- TA-255P Add Casters to Enclosed Base Food Units (includes 4 - 5" Bolted Swivel Casters, 2 w/ Brakes) **934 Set of 4**
- SU-19 Prepare Hot Tables to be Locked Together (One Charge For Each Table To Be Interlocked) **\$791 ea.**
- SU-45A 12" x 1" Adapter Bar **80 ea.**
- SU-45B 20" x 3" Adapter Bar **90 ea.**
- TCB-OMIT Remove Poly Cutting Board & Shelf **-227 ea.**
- CB-OMIT Remove Poly Cutting Board Only **-113 ea.**

Sleek Shields™ Are Also Available For Hot & Cold Food Tables. See Pages 140 For Details.

HEAVY DUTY TABLES

Heavy Duty Tables

HEAVY DUTY ELECTRIC SEALED WELL TABLES

- Heavy Duty Construction 300 Stainless Steel Body, Top and Legs
- Adjustable Stainless Steel Bullet Feet
- 8" Wide Poly Cutting Board Shelf - Ships K.D.
- Sealed Wells w/ Manifold Drains
- Thermostatic Controls
- 8 Ft. Electric Cord w/ Plug Included
- Control Knobs & Indicator Lights
- Removable Front Panel To Access Elements (Upgrade to 3 Phase Wiring for 240 Volt Units- Model # SU-72 8827)



Enclosed Base
HDSW-3-240-BS Shown
with Optional TA-255P Casters



Enclosed Base

Model #	Price	Length	Width*	# of Wells	Volts	Amps	Watts	Wt.	Cu. Ft.
HDSW-2-120-BS	\$13032	31-13/16"	35-3/4"	2	120	10.67	1280	225	31
HDSW-3-120-BS	15704	47-1/8"	35-3/4"	3	120	16	1920	340	45
HDSW-4-120-BS	18065	62-7/16"	35-3/4"	4	120	21.33	2560	430	60
HDSW-2-240-BS	13032	31-13/16"	35-3/4"	2	208/240	7.94/9.16	1650/2200	225	31
HDSW-3-240-BS	15704	47-1/8"	35-3/4"	3	208/240	11.91/13.74	2475/3300	340	45
HDSW-4-240-BS	18065	62-7/16"	35-3/4"	4	208/240	15.88/18.32	3300/4400	430	60
HDSW-5-240-BS	23575	77-3/4"	35-3/4"	5	208/240	19.85/22.90	4125/5500	520	74
HDSW-6-240-BS	27515	93-1/16"	35-3/4"	6	208/240	23.82/27.48	4850/6600	610	88

*Width Includes 8" Cutting Board

NOTE: Units are not designed to cook or heat frozen or refrigerated foods. Food placed in tables should already be hot, and the table will maintain the proper temperatures

Autofill Upgrade

Automatically fills & maintains water level. For DISW, DISLSW, SW & HDSW Series. Requires added cost Manifold Drain Assembly (Except HDSW series). See page 126.

SU-90 \$2904 Upgrade

Filler Faucet

- Hot Water Supply Only
 - Faucet Location To Be Specified When Ordering
 - Requires -M Manifold Drain Assembly
 - Add SU-15 \$1064 for Filler Faucet Provision
- K-49 \$546**



HEAVY DUTY Refrigerated Cold Well Tables

- Heavy Duty Construction 300 Stainless Steel Body, Top & Legs
- Adjustable Stainless Steel Bullet Feet
- Heavy Duty Cabinet Base
- 1" I.P.S. Drain
- Poly Cutting Board Shelf - Ships K.D.
- High Cooling Capacity
- Includes Adapter Bars For Optional Spillage Pans
- Low Running Current
- Precision Thermostat For Exact Temperature Control
- Single Phase Wiring
- 8 Ft. Electric Cord w/ Plug Included



Enclosed Base
HDRCP-3-BS Shown
with Optional TA-255P Casters

Model #	Price	Length	Width*	Refrigerant	Wt.	Cu. Ft.
HDRCP-2-BS	\$20228	31-13/16"	36-1/4"	R404-A	300 lbs.	39
HDRCP-3-BS	21217	47-1/8"	36-1/4"	R404-A	420 lbs.	56
HDRCP-4-BS	23575	62-7/16"	36-1/4"	R404-A	510 lbs.	73
HDRCP-5-BS	27504	77-3/4"	36-1/4"	R404-A	568 lbs.	90
HDRCP-6-BS	30256	93-1/16"	36-1/4"	R404-A	630 lbs.	90

*Width Includes 8" Cutting Board

SU-71 5 Year Extended Parts Warranty on Refrigeration Unit \$710 Per Unit
(Available for Refrigerated Tables & Drop-Ins.
See Back Inside Cover For Full Details)



CONNECT IT!

Prepare Tables To Be Locked Together While Keeping Them Lined Up! (One Charge For Each Table To Be Interlocked)
SU-19 \$791 per table

WARNING: Refrigerated Equipment on this page may expose you to chemicals, including Fluorides, that are known to the State of California to cause cancer or birth defects or other reproductive harm. For more info, visit www.p65warnings.ca.gov

HEAVY DUTY ICE-COOLED TABLES

- Stainless Steel Body, Top And Legs
- Adjustable Stainless Steel Bullet Feet
- High Cooling Capacity
- Heavy Duty Cabinet Base
- 8" Wide Poly Cutting Board Shelf - Ships K.D.



Enclosed Base
HDCPU-3-BS Shown
with Optional TA-255P Casters



Enclosed Base

Model #	Price	Length	Width*	Wt.	Cu. Ft.	Model #	Price	Length	Width*	Wt.	Cu. Ft.
HDCPU-2-BS	\$9906	31-13/16"	36-1/4"	117 lbs.	27	HDCPU-2-DR	\$10229	31-13/16"	36-1/4"	127 lbs.	27
HDCPU-3-BS	11724	47-1/8"	36-1/4"	145 lbs.	39	HDCPU-3-DR	12330	47-1/8"	36-1/4"	155 lbs.	39
HDCPU-4-BS	12676	62-7/16"	36-1/4"	205 lbs.	58	HDCPU-4-DR	13053	62-7/16"	36-1/4"	215 lbs.	58
HDCPU-5-BS	15708	77-3/4"	36-1/4"	250 lbs.	69	HDCPU-5-DR	16265	77-3/4"	36-1/4"	284 lbs.	69
HDCPU-6-BS	17197	93-1/16"	36-1/4"	295 lbs.	81	HDCPU-6-DR	17893	93-1/16"	36-1/4"	309 lbs.	81

*Width Includes 8" Cutting Board

See Pages 137-140 For Shelving & Accessories!

BUFFET TABLES

Everyday Buffet Hot Food Tables

For Use with Optional Spillage Pans

- Stainless Steel Top And Body
- Matte Black Vinyl Clad
- 8" Deep Liners For Optional SP-A Or SP-S Spillage Pans
- 1/4" Thick, Double Sided Thermoplastic Polymer Sneeze Guard & Side Panels
- 4" Swivel Casters, Two With Brakes
- Fiberglass Insulation
- Pre-Drilled For Optional Solid Drop-Down Tray Shelf available for one or both sides

- Infinite Control Knobs
- Indicator Lights
- 8 Ft. Electric Cord w/ Plug Included
- Single Phase Wiring (Upgrade to 3 Phase Wiring for 240 Volt Units- Model # SU-72 \$690)
- To Omit Sneeze Guard use Model # BSG-OMIT deduct \$397



Open Base
B3-120-B-S Shown

Open Base

Galvanized Liners	Price	Stainless Steel Liners	Price	Length	# of Wells	NEMA Plug	Volts	Amps	Watts	Wt.	Cu. Ft.
B2-120-B	\$6029	B2-120-B-S	\$6757	31-13/16"	2	5-20P	120	8.33	1000	135 lbs.	39
B3-120-B	6613	B3-120-B-S	7085	47-1/8"	3	5-20P	120	12.50	1500	246 lbs.	56
B4-120-B	7488	B4-120-B-S	8183	62-7/16"	4	L5-30P	120	16.67	2000	301 lbs.	73
B2-240-B	6029	B2-240-B-S	6757	31-13/16"	2	6-20P	208/240	7.21/8.33	1500/2000	135 lbs.	39
B3-240-B	6402	B3-240-B-S	7085	47-1/8"	3	6-20P	208/240	10.82/12.50	2250/3000	170 lbs.	57
B4-240-B	7488	B4-240-B-S	8183	62-7/16"	4	L6-30P	208/240	14.42/16.67	3000/4000	310 lbs.	73
B5-240-B	9233	B5-240-B-S	9673	77-3/4"	5	L6-30P	208/240	18.03/20.84	3750/5000	343 lbs.	90

Enclosed Base

Galvanized Liners	Price	Stainless Steel Liners	Price	Length	# of Wells	NEMA Plug	Volts	Amps	Watts	Wt.	Cu. Ft.
B2-120-B-SB	\$7526	B2-120-B-S-SB	\$7889	31-13/16"	2	5-20P	120	8.33	1000	135 lbs.	39
B3-120-B-SB	8330	B3-120-B-S-SB	8878	47-1/8"	3	5-20P	120	12.50	1500	170 lbs.	56
B4-120-B-SB	9134	B4-120-B-S-SB	10058	62-7/16"	4	L5-30P	120	16.67	2000	310 lbs.	73
B2-240-B-SB	7526	B2-240-B-S-SB	7889	31-13/16"	2	6-20P	208/240	7.21/8.33	1500/2000	135 lbs.	39
B3-240-B-SB	8330	B3-240-B-S-SB	8878	47-1/8"	3	6-20P	208/240	10.82/12.50	2250/3000	170 lbs.	56
B4-240-B-SB	9134	B4-240-B-S-SB	10058	62-7/16"	4	L6-30P	208/240	14.42/16.67	3000/4000	210 lbs.	73
B5-240-B-SB	10507	B5-240-B-S-SB	11325	77-3/4"	5	L6-30P	208/240	18.03/20.84	3750/5000	235 lbs.	90



Enclosed Base
B3-120-B-SB Shown

BUFFET TABLE SEALED WELL WITH ENCLOSED BASE

- Stainless Steel Top And Body
- Stainless Steel Sealed Wells with Manifold Drains
- Matte Black Vinyl Clad
- 10 Gauge Aluminum Dome Shape Heat Element
- 20 Gauge Stainless Steel Deep Drawn Bowls With 1" Drain
- 1/4" Thick, Double Sided Thermoplastic Polymer Sneeze Guard And Side Panels
- 4" Swivel Casters, Two With Brakes
- Fiberglass Insulation

- Optional Solid Drop-Down Tray Shelf available for one or both sides
- Infinite Control Knobs
- Indicator Lights
- Single Phase Wiring
- Single Phase Wiring (Upgrade to 3 Phase Wiring for 240 Volt Units- Model # SU-72 \$690)
- 8 Ft. Electric Cord w/ Plug Included
- To Omit Sneeze Guard use Model # BSG-OMIT deduct \$397



Enclosed Base
BSW3-120-B-SB Shown

Enclosed Base

Stainless Steel Liners	Price	Length	# of Wells	NEMA Plug	Volts	Amps	Watts	Wt.	Cu. Ft.
BSW2-120-B-SB	\$8952	31-13/16"	2	5-20P	120	10.67	1280	300 lbs.	30
BSW3-120-B-SB	9556	47-1/8"	3	5-20P	120	16	1920	325 lbs.	43
BSW4-120-B-SB	10776	62-7/16"	4	L5-30P	120	21.33	2560	356 lbs.	55
BSW2-240-B-SB	8952	31-13/16"	2	6-20P	208/240	7.94/9.16	1650/2200	300 lbs.	30
BSW3-240-B-SB	9556	47-1/8"	3	6-20P	208/240	11.91/13.74	2475/3300	325 lbs.	43
BSW4-240-B-SB	10776	62-7/16"	4	L6-30P	208/240	15.88/18.32	3000/4400	356 lbs.	55
BSW5-240-B-SB	12574	77-3/4"	5	L6-30P	208/240	19.85/22.90	4125/5500	370 lbs.	68

NOTE: Units are not designed to cook or heat frozen or refrigerated foods. Food placed in tables should already be hot, and the table will maintain the proper temperatures

See Pages 137-140 For Shelving & Accessories!

END SHELF FOR HOT/COLD TABLES

(Excludes HDSW, HDPCP & HDPCU Units)

- 10" Wide x 22 1/2" Length
- Stainless Steel

Stationary	Drop-Down
TES-1	TES-1D
\$1013	\$1195



BUFFET TABLES

Everyday Buffet Ice-Cooled Tables

For Use with Optional Spillage Pans

- Stainless Steel Top And Body
- Matte Black Vinyl Clad
- 9" Deep Liners With Adapter Bars
- For Optional **SP-A** Or **SP-S** Spillage Pans
- 1/4" Thick, Double Sided Thermoplastic Polymer Sneeze Guard And Side Panels
- 4" Swivel Casters, Two With Brakes
- Fiberglass Insulation
- Pre-Drilled For Optional Solid Drop-Down Tray Shelf available for one or both sides
- To Omit Sneeze Guard use **Model # BSG-OMIT** deduct **\$397**

Open Base

Model	Price	Length	# of Wells	Wt.	Cu. Ft.
B2-CPU-B	\$5653	35-15/16"	2	252 lbs.	59
B3-CPU-B	6182	53-1/9"	3	280 lbs.	85
B4-CPU-B	6714	69-8/18"	4	347 lbs.	109
B6-CPU-B	7690	86-3/4"	6	392 lbs.	133



Open Base
B3-CPU-B Shown

Enclosed Base

Model	Price	Length	# of Wells	Wt.	Cu. Ft.
B2-CPU-B-SB	\$6383	35-15/16"	2	263 lbs.	59
B3-CPU-B-SB	6619	53-1/9"	3	291 lbs.	85
B4-CPU-B-SB	7236	69-8/18"	4	358 lbs.	109
B6-CPU-B-SB	8368	86-3/4"	6	403 lbs.	133



Enclosed Base
B3-CPU-B-SB Shown

NOTE: Units are not designed to cool foods originally warm. Food should already be chilled to maintain the proper temperatures

Everyday Buffet Tables with Solid Top

- Stainless Steel Top And Body
- Solid Stainless Steel Top
- Matte Black Vinyl Clad
- 1/4" Thick, Double Sided Thermoplastic Polymer Sneeze Guard on top and side panels and Side Panels
- 4" Swivel Casters, Two With Brakes
- Optional Solid Drop-Down Tray Shelf available for one or both sides
- To Omit Sneeze Guard use **Model # BSG-OMIT** deduct **\$397**

Open Base

Model	Price	Length	Wt.	Cu. Ft.
B2-STU-B	\$5843	35-15/16"	291 lbs.	59
B3-STU-B	6249	53-1/9"	336 lbs.	85
B4-STU-B	7019	69-8/18"	370 lbs.	109
B6-STU-B	8028	86-3/4"	414 lbs.	133



Open Base
B3-STU-B Shown

ENCLOSED BASE

Model	Price	Length	Wt.	Cu. Ft.
B2-STU-B-SB	\$6212	36"	302 lbs.	59
B3-STU-B-SB	7016	53"	347 lbs.	85
B4-STU-B-SB	7824	70"	381 lbs.	109
B6-STU-B-SB	8264	87"	426 lbs.	133



Enclosed Base
B3-STU-B-SB Shown

See Pages 137-140 For Shelving & Accessories!

BUFFET TABLES

Mechanically Assisted Everyday Buffet Tables

For Use with Optional Spillage Pans



COLD PAN TABLES WITH ENCLOSED BASE

- Stainless Steel Top, Liner And Body
- Self contained condensing unit provided with a hermetically sealed compressor with a digital, programmable thermostat
- Full Insulation With 22 Gauge Galvanized Outer Jacket
- Removable access door to compressor
- Fiberglass Insulation
- High Cooling Capacity
- Sight Glass To Ensure Properly Charges System
- Low Running Current
- Precision Thermostat For Exact Temperature Control
- 1" I.P.S. Drain
- 1/4" Thick, Double Sided Thermoplastic Polymer Sneeze Guard And Side Panels
- 4" Swivel Casters, Two With Brakes
- Includes Food Pan Adapters For optional 12" X 20" Pans
- Matte Black Vinyl Clad
- Pre-Drilled For Optional Solid Drop-Down Tray Shelf available for one or both sides
- Single Phase Wiring
- 8 Ft. Electric Cord w/ Plug Included
- To Omit Sneeze Guard use Model # BSG-DMT deduct \$397



Enclosed Base
BMACP3-B-SB Shown

Model	Price	Length	# of Wells	NEMA Plug	Refrigerant	Wt.	Cu. Ft.
BMACP2-B-SB	\$14353	31-13/16"	2	5-20P	R404-A	250 lbs.	30
BMACP3-B-SB	15338	47-1/8"	3	5-20P	R404-A	300 lbs.	43
BMACP4-B-SB	16129	62-7/16"	4	5-20P	R404-A	345 lbs.	55
BMACP5-B-SB	17177	77-3/4"	5	5-20P	R404-A	395 lbs.	68

NOTE: Units are not designed to cook or heat frozen or refrigerated foods. Food placed in tables should already be hot, and the table will maintain the proper temperatures

SU-71 5 Year Extended Parts Warranty on Refrigeration Unit \$710 Per Unit
(Available for Refrigerated Tables & Drop-Ins. See Back Inside Cover For Full Details)

CONNECT IT!
Prepare Tables To Be Locked Together While Keeping Them Lined Up!
(One Charge For Each Table To Be Interlocked)
SU-19 \$791 per table

WARNING: Refrigerated Equipment on this page may expose you to chemicals, including Ethanes, that are known to the State of California to cause cancer or birth defects or other reproductive harm. For more info, visit www.p66warnings.ca.gov

PORTABLE CASH REGISTER STANDS WITH DRAWER & KEY LOCK

- 20 Gauge, 304 Stainless Steel Frame
- Locking Drawer
- 4" Swivel Casters With Two Brakes
- Open Storage Area
- Matte Black Vinyl Clad



Add Holes For Power Cord (Requires 2)
TA-108 \$174 per hole



Model	Price	Length	Width	Height	Wt.	Cu. Ft.
BCRS-B	\$3528	22 1/2"	22 1/2"	34 3/8"	140 lbs.	19

WITH LOCKING DOOR

- Stainless Steel Interior, Frame And Bottom
- Adjustable Hinges & Locking Door w/ Key
- Full Perimeter Bumpers
- Mid-Shelf
- Black Mica Finish On Door, Top & Sides
- Open Bottom Shelf For Glass Rack Storage
- 4" Swivel Casters With Two Brakes



Model	Price	Length	Width	Height	Wt.	Cu. Ft.
AMD-2B	\$3196	24.5"	23.5"	40.5"	160 lbs.	27

EVERYDAY BUFFET SILVERWARE STAND

- 20 Gauge, 304 Stainless Steel Frame
- Includes 12 Plastic Silverware Cups
- 4" Swivel Casters With Two Brakes
- Matte Black Vinyl Clad



(Trays & silverware shown not included)

Model	Price	Length	Width	Height	Wt.	Cu. Ft.
BSWS-B	\$4300	31.875"	22.4"	40"	160 lbs.	28

Food Table Modifications & Accessories

For Our Full Line Of Hot Food Table Modifications, Accessories & Replacement Parts, See Page 137-140

TCB-OMIT	Remove Poly Cutting Board	-\$227 ea.	SU-45A	12" x 1" Adapter Bar	80 ea.
CB-OMIT	Remove Poly Cutting Board Only	-113 ea.	SU-45B	20" x 3" Adapter Bar	90 ea.
SU-6	Hot/Cold Food Table Handle	\$248 ea.	SU-72	Upgrade 240 volt units to 3-Phase Wiring	690 ea.
SU-6-B	Everyday Buffet Handle	\$248 ea.	SP-A	Aluminum Spillage Pan	183 ea.
SU-6-HD	Heavy Duty Hot/Cold Food Table Handle	\$248 ea.	SP-S	Stainless Steel Spillage Pan	321 ea.
SU-19	Prepare Hot Tables To Be Locked Together (One Charge For Each Table To Be Interlocked)	791 ea.			



ACCESSORIES

Hot/Cold Food Table Shelving

TRAY SHELVES

10" Wide Stainless Steel Tray Shelves



STATIONARY		DROP-DOWN		Length	Approx. Wt.	Cu. Ft.
Model	Price	Model	Price			
TTS-2	\$1058	TTS-2D	\$1242	31-13/16"	15 lbs.	3
TTS-3	1251	TTS-3D	1444	47-1/8"	17 lbs.	4
TTS-4	1280	TTS-4D	1538	62-7/16"	19 lbs.	5
TTS-5	1536	TTS-5D	1717	77-3/4"	22 lbs.	6
TTS-6	1871	TTS-6D	2093	93-1/16"	25 lbs.	6

12" Wide Stainless Steel Tray Rails



STATIONARY		DROP-DOWN		Length	Approx. Wt.	Cu. Ft.
Model	Price	Model	Price			
TTR-2	\$961	TTR-2D	\$1123	31-13/16"	14 lbs.	3
TTR-3	1180	TTR-3D	1354	47-1/8"	16 lbs.	4
TTR-4	1326	TTR-4D	1452	62-7/16"	18 lbs.	5
TTR-5	1540	TTR-5D	1672	77-3/4"	21 lbs.	6
TTR-6	1879	TTR-6D	2039	93-1/16"	23 lbs.	6

8" WIDE SHELF

With Removable
3/8" Thick Poly Cutting Board



- All Stainless Steel Construction
- Cutting Board Attaches To Top Shelf Using Acorn Nuts

Model	Price	Length	Approx. Wt.	Cu. Ft.
TCB-2	\$458	31-13/16"	16 lbs.	3
TCB-3	620	47-1/8"	19 lbs.	4
TCB-4	778	62-7/16"	23 lbs.	5
TCB-5	905	77-3/4"	26 lbs.	6
TCB-6	1062	93-1/16"	29 lbs.	7

TCB-OMIT Remove Poly Cutting Board & Shelf **-\$227 ea.**
 CB-OMIT Remove Poly Cutting Board Only **-113 ea.**

Replacement 3/8" Poly Cutting Boards



Model	Price	Length	Approx. Wt.
SU-P-342	\$242	31-13/16"	9 lbs.
SU-P-343	294	47-1/8"	11 lbs.
SU-P-344	330	62-7/16"	13 lbs.
SU-P-345	352	77-3/4"	15 lbs.
SU-P-346	404	93-1/16"	18 lbs.

7" WIDE DISH SHELF

Connects To TCB Series Shelf

Includes 2 Side Panels & Lower Shelf



Model	Price	Length	Approx. Wt.	Cu. Ft.
TDS-2	\$840	31-13/16"	20 lbs.	3
TDS-3	1003	47-1/8"	27 lbs.	4
TDS-4	1326	62-3/8"	31 lbs.	5
TDS-5	1528	77-3/4"	38 lbs.	6
TDS-6	1723	93-1/16"	45 lbs.	7

END SHELF FOR HOT/COLD TABLES

(Excludes HDRCP, HDSW & HDPCU Units)

- 10" Wide x 22 1/2" Length
- Stationary or Drop-Down
- All Stainless Steel Construction



STATIONARY		DROP-DOWN		Approx. Wt.	Cu. Ft.
Model	Price	Model	Price		
TES-1	\$1013	TES-1D	\$1195	15 lbs.	3

TABLE MOUNTED OVERSHELVES

- TOS Series: Upper Shelf Secures To Lower Shelf With Expander Hardware (Included)
- Shipped KD



12" Wide			18" Wide			Length	Cu. Ft.
Model	Price	Approx. Wt.	Model	Price	Approx. Wt.		
Single Tier							
STOS-2	\$1208	18 lbs.	STOS-2-18	\$1536	20 lbs.	31-13/16"	3
STOS-3	1372	21 lbs.	STOS-3-18	1653	23 lbs.	47-1/8"	4
STOS-4	1544	24 lbs.	STOS-4-18	1790	26 lbs.	62-7/16"	5
STOS-5	1672	27 lbs.	STOS-5-18	1954	30 lbs.	77-3/4"	6
STOS-6	2039	33 lbs.	STOS-6-18	2383	35 lbs.	93-1/16"	6
Double Tier							
TOS-2	2191	32 lbs.	TOS-2-18	2606	35 lbs.	31-13/16"	3
TOS-3	2558	38 lbs.	TOS-3-18	3007	56 lbs.	47-1/8"	4
TOS-4	2924	44 lbs.	TOS-4-18	3435	47 lbs.	62-7/16"	5
TOS-5	3287	49 lbs.	TOS-5-18	3853	53 lbs.	77-3/4"	6
TOS-6	4012	56 lbs.	TOS-6-18	4703	61 lbs.	93-1/16"	6

ACCESSORIES

Hot/Cold Food Table Food Shields

Sleek Shields™



Meets Latest NSF Standards

Protected By: Patent No. US 9,010,883 B2

GLASS FOOD SHIELDS

Mounts To Top Of Hot/Cold Food Tables On Pgs. 127-135 (Excluding Drop-In Wells)

- 18 3/4" Standard Height (Top of Table To Top)
- 18" Wide Glass Top or Stainless Steel Shelf
- **NSG/NSGC Models:** Shelves Have Square Edges On All Four Sides.
- **GSG Models:** Glass Top Features 3/8" Heat-Tempered Glass Top
- 1" Stainless Steel Tubing Posts
- Includes Two 18" Wide x 16 3/8" High Glass Side Panels
- 1/4" Thick Heat-Tempered Glass Front & Sides*
- Ships KD



FEATURING ADVANCE TABCO'S REVOLUTIONARY CHAMBER LOCK™ ROTATION SYSTEM

Front Glass Locks Into Place At 15° Intervals

For Double Sided Sleek Shields™
On Everyday Buffets Please Consult Factory



NSG-15-4WELL Shown



Includes TA-47 Mounting Brackets For In-Field Installation

Self-Serve - Single Side

15" Wide Stainless Steel Shelf			15" Wide w/ Glass Top			Fits # of Bowls	Approx. Wt.	Approx. Cubes
Model #	Price	O.A. Size L x W x H	Model #	Price	O.A. Size L x W x H			
NSG-15-2WELL	\$4826	33 11/16" x 19 3/4" x 18 3/4"	GSG-15-2WELL	\$5790	33 11/16" x 19 3/4" x 18"	Fits 2-Well Unit	109 lbs.	15
NSG-15-3WELL	5024	49" x 19 3/4" x 18 3/4"	GSG-15-3WELL	6008	49" x 19 3/4" x 18"	Fits 3-Well Unit	143 lbs.	22
NSG-15-4WELL*	5881	64 5/16" x 19 3/4" x 18 3/4"	GSG-15-4WELL*	6392	64 5/16" x 19 3/4" x 18"	Fits 4-Well Unit	186 lbs.	29
NSG-15-5WELL**	6423	79 5/8" x 19 3/4" x 18 3/4"		Not Available		Fits 5-Well Unit	215 lbs.	38
NSG-15-6WELL**	7114	94 15/16" x 19 3/4" x 18 3/4"		Not Available		Fits 6-Well Unit	247 lbs.	47

*3/8" Thick Heat-Tempered Glass Required For Front Glass **Requires a Single Center Post (Factory Post Included)

Cafeteria Style - Single Side

15" Wide Stainless Steel Shelf			Fits # of Bowls	Approx. Wt.	Approx. Cubes
Model #	Price	O.A. Size L x W x H			
NSGC-15-2WELL	\$5789	33 11/16" x 18" x 18 3/4"	Fits 2-Well Unit	135 lbs.	15
NSGC-15-3WELL	5962	49" x 18" x 18 3/4"	Fits 3-Well Unit	176 lbs.	22
NSGC-15-4WELL*	6531	64 5/16" x 18" x 18 3/4"	Fits 4-Well Unit	232 lbs.	29
NSGC-15-5WELL**	6949	79 5/8" x 18" x 18 3/4"	Fits 5-Well Unit	265 lbs.	38
NSGC-15-6WELL**	7773	94 15/16" x 18" x 18 3/4"	Fits 6-Well Unit	300 lbs.	47

*3/8" Thick Heat-Tempered Glass Required For Front Glass **Requires a Center Leg (Factory Post Included)



NSGC-15-4WELL Shown

For Sleek Shield™ Modifications, Accessories and Heat Lamps, See Page 73

Due to mounting requirements, food shields extend 15/16" beyond the end of the hot or cold table on each end. Units set side by side must allow for this additional space.

Self-Serve - Double Sided

- 18 3/4" Standard Height (Top of Table To Top)
- 22 3/4" Wide Stainless Steel Shelf with Square Edges On All Four Sides.
- 1" Stainless Steel Tubing Posts
- Includes Two 18 3/8" High Glass Side Panels
- 1/4" Thick Heat-Tempered Glass Front & Sides
- Ships Set Up

25" Wide Stainless Steel Shelf			Fits # of Bowls	Approx. Wt.	Approx. Cubes
Model #	Price	O.A. Size L x W x H			
NSGD-26-2WELL	\$8217	33 1/16" x 32 1/4" x 18 3/4"	Fits 2-Well Unit	285 lbs.	20
NSGD-26-3WELL	8439	49" x 32 1/4" x 18 3/4"	Fits 3-Well Unit	340 lbs.	27
NSGD-26-4WELL*	9408	64 5/16" x 32 1/4" x 18 3/4"	Fits 4-Well Unit	425 lbs.	36
NSGD-26-5WELL**	9599	79 5/8" x 32 1/4" x 18 3/4"	Fits 5-Well Unit	515 lbs.	44
NSGD-26-6WELL**	10229	93 1/8" x 32 1/4" x 18 3/4"	Fits 6-Well Unit	605 lbs.	54

*3/8" Thick Heat-Tempered Glass Required For Front Glass **Requires a Single Center Post (Factory Post Included)



NSGD-26-4WELL Shown

Due to mounting requirements, food shields extend 15/16" beyond the end of the hot or cold table on each end. Units set side by side must allow for this additional space.

ACCESSORIES

Hot & Cold Table Accessories

CAFETERIA SHELVES W/ BUILT-IN ACRYLIC FOOD SHIELDS

Features Removable Stainless Steel Shelf

Single Sided Cafeteria Style

- 15" High
- 1" Clearance From Table Top

Model	Price	Length	Approx. Wt.	Cu. Ft.
TSS-2	\$1503	31-13/16"	17 lbs.	2
TSS-3	1711	47-1/8"	20 lbs.	3
TSS-4	1866	62-7/16"	23 lbs.	4
TSS-5	2003	77-3/4"	33 lbs.	4
TSS-6	2393	93-1/16"	33 lbs.	5



Double Sided Self-Serve Style

- 19-3/4" High
- 10" Clearance From Table Top

Model	Price	Length	Approx. Wt.	Cu. Ft.
TBS-2	\$2386	31-13/16"	28 lbs.	2
TBS-3	2463	47-1/8"	33 lbs.	3
TBS-4	2688	62-7/16"	38 lbs.	4
TBS-5	3078	77-3/4"	45 lbs.	4
TBS-6	3346	93-1/16"	52 lbs.	5



Acrylic Side Panel for TSS Series Shelves

Add Side Panels To Meet Additional NSF Requirements (1 Panel Per End) TSP-1 \$380 One End TSP-2 \$779 Two Ends
Field Installation Available



Acrylic Side Panel for TBS Series Shelves

Add Side Panels To Meet Additional NSF Requirements (2 Panels Per End) TBP-1 \$458 One End TBP-2 \$913 Two Ends
Field Installation Available

LED Display Lighting

For Everyday Buffets & Hot/Cold Table Shelving



- Aluminum Rail with Shatter-Proof Optics
- Natural Aluminum Finish (Black or White Available On Request)
- Includes Class 2 Low Voltage Power Supply 120V-277V
- High Impact Resistant Mounting Clips

NOTE: Require 6" clearance on both sides to fit above LED Lighting. **PRINT REQUIRED FOR PROPER LED LOCATION. FACTORY INSTALLED ONLY**



LED-B Series For Everyday Buffets



LED-H Series For Overshelves or Food Shields



LED-G Series For GSG Series Food Shields

Fits # of Wells	For use with Everyday Buffets		For use with STOS, TOS, TBS, TSS, NSG or NSGC Overshelves or Food Shields		For use with GSG Food Shields		LED Length
	Model #	Price	Model #	Price	Model #	Price	
2	LED-B-2	\$2075	LED-H-2	\$2075	LED-G-24	\$944	24"
3	LED-B-3	2433	LED-H-3	2433	LED-G-36	1045	36"
4	LED-B-4	2794	LED-H-4	2794	LED-G-48	1139	48"
5	LED-B-5	3200	LED-H-5	3199	Consult Factory		60"
6	Not Available		LED-H-6	3620	Consult Factory		72"

Individual Well Covers For Hot Food Tables

- Stainless Steel
- Removable
- Fits All Advance Tabco Hot Well Units



HFC-1 \$502 Per Well

Flip-Up Cover For Hot Food Tables

- Stainless Steel
- Removable
- Fits Advance Tabco Hot Well Units



Model #	Price	Fits # of Comp.	Wt.	Cu.
RC-1	\$1044	1	23	5
RC-2	1180	2	60	10
RC-3	1360	3	74	15
RC-4*	1896	4	120	20
RC-5**	2114	5	134	25

* Supplied with Two RC-2 Covers

** Supplied with One RC-2 & One RC-3 Cover

Hinge Style Cover For Cold Food Tables

- Stainless Steel
- Plastic Handles & Piano Style Hinge(s)
- Fits CPU, DICP & MACP & BMACP Units



Model #	Price	Fits # of Comp.	Wt.	Cu.
HC-2	\$553	2	12	3
HC-3	827	3	16	4
HC-4	905	4	20	5
HC-5	1051	5	24	6



SP-A



TA-25SP



SU-25S

Stainless Steel Legs & Undershell Upgrade

2 Wells	3 Wells	4 Wells	5 Wells
SU-23A \$1080	SU-23B \$1117	SU-23C \$1185	SU-23D \$1332

SU-6 Hot/Cold Food Table Handle \$248 ea.

SU-25S Add Casters to Food Units w/Undershell (Includes 4 - 5" Swivel Casters, 2 w/ Brakes & Legs that maintain height) 646 Set of 4

SU-25 Add Casters to Food Units w/Undershell (For Units Built Before October 2018. Includes 4 - 5" Swivel Casters, 2 w/ Brakes.) 594 Set of 4

SU-19 Connect Cafeteria Items (One Charge For Each Table To Be Interlocked) 791 per table

TA-25 Replacement Casters For Undershell Units (For Units Built after October 2018. Includes 4 - 5" Swivel Casters, 2 w/ Brakes.) 594 Set of 4

TA-25SP Add Casters to Enclosed Base Food Units (Includes 4 - 5" Robbed Swivel Casters, 2 w/ Brakes) 934 Set of 4

SU-32G Upgrade to a Stainless Steel Lining (For Gas Units. Excludes Wetbar Units) 168 per well

SP-A Aluminum Spillage Pan 183 ea.

SP-S Stainless Steel Spillage Pan 321 ea.

TCB-OMIT Remove Poly Cutting Board & Shelf -227 ea.

CB-OMIT Remove Poly Cutting Board -113 ea.

REPLACEMENT PARTS













Replacement Parts For Hot Food Tables

All Items on This Page Ship via UPS

FOR GAS HOT FOOD TABLES

	Gas Valve Hi/Med/Lo SU-P-101 \$111		Jet Burners SU-P-105 \$173 NAT 5/16 #61 SU-P-106 \$173 LP 5/16 #74		Pilot Assembly HF-xG SU-P-102 \$125
	Valve Adapter SU-P-104 \$65		Gas Pilot For Wet Bath Units SU-P-107 \$267		Gas Infinite Control Knob SU-P-202 \$63
	Gas Pilot Valve SU-P-108 \$81		Gas Deflector SU-P-411 \$47 Standard HFxG Units SU-P-412 \$69 Stainless For SU-32G Wells		1 1/2" Drain Stainless Steel For Wetbath Tables SU-P-103 \$90
	Gas Regulator SU-P-109 \$152				Strainer Screen For Sealed Well Tables SU-P-403 \$29

FOR ELECTRIC HOT FOOD TABLES

ELECTRIC HEATING ELEMENTS For Exposed Element (Dry) Models SU-P-207 \$173 500W 120V SU-P-204 \$173 1000W 240V			Electric Infinite Control Knob SU-P-201 \$63		Replacement Sealed Well Sub-Assembly SU-P-401 \$1064 Without Element or High Limit Switch
For Concealed Element Sealed Well (Wet) Models SU-P-209 \$197 640W 120V SU-P-206 \$197 1100W 240V SU-P-210 \$197 1100W 120V - For Drop-In Units Only			Thermostatic Knob (For Units with Thermostatic Control) SU-P-219 \$68		SU-P-402 \$62 Sealed Well or Element Pan Only
Thermostatic Control Replacement Thermostatic Control SU-P-220A \$312 Per Well 120v/240v, 24" lead For Free-Standing Sealed Well Hot Food Units SU-P-220B \$312 Per Well 120v/240v, 72" lead For Drop-In Sealed Well Hot Food Units			Infinite Control SU-P-205 \$151 120V SU-P-215 \$151 240V	NEMA Plugs 8' Cord Set  SU-P-230 \$144 NEMA 5-20P  SU-P-231 \$400 NEMA LS-30P  SU-P-232 \$144 NEMA 6-20P  SU-P-233 \$400 NEMA LS-30P  SU-P-234 \$223 NEMA 5-15	
			Indicator Lights SU-P-216 \$109 120V SU-P-217 \$109 240V		
			High Limit Switch Assembly SU-P-208 \$233 347F		

ALUMINUM RACKS

Aluminum Pan Racks



FRONT LOAD

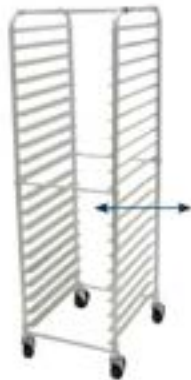

SIDE LOAD



K.D. PAN RACKS

- 6 Cylindrical Support Bars
- 1" Square Tubing
- 5" Poly Stem Bolted Casters
- 1 1/2" Ribbed Angles
- Shipped K.D.
- Easy To Assemble

Model #	Price	Description	Pan Capacity	Shelf Spacing	Overall Size	Approx. Wt.
PR10-3K	\$849	Front Load	10 Full or 20 Half Size	3"	20 1/4" x 26" x 38 1/4"	14 lbs.
PR12-5K	893	Front Load	12 Full or 24 Half Size	5"	20 1/4" x 26" x 69 1/4"	24 lbs.
PR18-3K	1066	Front Load	18 Full or 36 Half Size	3"	20 1/4" x 26" x 63 1/4"	31 lbs.
PR20-3K	1008	Front Load	20 Full or 40 Half Size	3"	20 1/4" x 26" x 69 1/4"	33 lbs.
PR30-2K	1080	Front Load	30 Full Size	2"	20 1/4" x 26" x 69 1/4"	39 lbs.
PR18-3KS	1002	Side Load	18 Full Size	3"	28 1/4" x 18" x 63 1/4"	31 lbs.
PR20-3KS	1051	Side Load	20 Full Size	3"	28 1/4" x 18" x 69 1/4"	27 lbs.

SEE PAGE 146 FOR PROPER REPLACEMENT CASTERS



ALL WELDED - CURVED TOP - STANDARD



SIDE LOAD



- Heavy Duty Welded Construction
- 1" Square Tubing
- Curved Top
- 5" Poly Stem Bolted Casters
- 6 Cross Supports
- 1 1/2" Heavy Duty Ribbed Angles

Model #	Price	Description	Pan Capacity	Shelf Spacing	Overall Size	Approx. Wt.
PR10-3W	\$1005	Front Load	10 Full or 20 Half Size	3"	20 1/4" x 26" x 38 1/2"	25 lbs.
PR10-6W	1162	Front Load	10 Full or 20 Half Size	6"	20 1/4" x 26" x 69 1/4"	27 lbs.
PR12-5W	1183	Front Load	12 Full or 24 Half Size	5"	20 1/4" x 26" x 69 1/4"	28 lbs.
PR15-4W	1198	Front Load	15 Full or 30 Half Size	4"	20 1/4" x 26" x 69 1/4"	31 lbs.
PR18-3W	1219	Front Load	18 Full or 36 Half Size	3"	20 1/4" x 26" x 63 1/4"	34 lbs.
PR20-3W	1232	Front Load	20 Full or 40 Half Size	3"	20 1/4" x 26" x 69 1/4"	35 lbs.
PR30-2W	1444	Front Load	30 Full or 60 Half Size	2"	20 1/4" x 26" x 69 1/4"	43 lbs.
PR10-6WS	1318	Side Load	10 Full Size	6"	28 1/4" x 18" x 69 1/4"	26 lbs.
PR12-5WS	1334	Side Load	12 Full Size	5"	28 1/4" x 18" x 69 1/4"	27 lbs.
PR15-4WS	1476	Side Load	15 Full Size	4"	28 1/4" x 18" x 69 1/4"	30 lbs.
PR18-3WS	1511	Side Load	18 Full Size	3"	28 1/4" x 18" x 63 1/4"	27 lbs.
PR20-3WS	1527	Side Load	20 Full Size	3"	28 1/4" x 18" x 69 1/4"	34 lbs.

ALUMINUM RACKS

Specialty Racks

ENCLOSED PAN CABINETS

- 14 Ga. Aluminum, Heavy Duty Welded Construction
 - Enclosed Extrusions
 - 5" Poly Plate Casters, 2 With Brakes
 - Flip Style Door Latch Handle
 - Side Door Lock to Prevent Opened Door From Swinging
 - 37 Pan Capacity
 - Optional Bumpers Available
 - Optional Pull Handle For Improved Mobility.
- Does Not Interfere With Other Side By Side Units.



Model #	Price	Description	Pan Capacity	Shelf Spacing	Overall Size	Approx. Wt.
EPC-40	\$3388	Front Load	37 Full or 74 Half Size	1 1/2"	20 1/2" x 27 1/2" x 66 1/4"	110 lbs.

Optional Accessories

Model #	Description	Price
RA-21	Optional Pull Handle	\$490
RA-22	Full Perimeter Bumpers	342
RA-23	Corner Bumpers	273

FULL & HALF SIZE CAN RACKS

Aluminum Top Poly Top Stainless Steel Top



Half Can Rack



Full Can Rack



Full Can Rack With Casters

SPEC-LINE



- Heavy Duty Welded Construction
- Metal Bullet Feet on CR10-162 only
- 4" Plate Casters with two Brakes. Standard on all Can Racks EXCEPT CR10-162 (See CR10-162M).

Model #	Price	Description	Can Capacity		Overall Size	Approx. Wt.
			#10	#5		
CR10-162	\$2310	Full Can Rack	162	216	24 3/4" x 35 1/8" x 69 3/4"	65 lbs.
CR10-162M	2856	Full Can Rack (with Casters)	162	216	24 3/4" x 35 1/8" x 69 3/4"	76 lbs.
CR10-72	2237	Aluminum Top	72	96	24 3/4" x 35 1/8" x 40 1/8"	59 lbs.
CR10-54	1969	Aluminum Top	54	72	24 3/4" x 35 1/8" x 32 5/8"	54 lbs.
CRPL10-72	2467	Poly Top	72	96	24 3/4" x 35 1/8" x 40 1/8"	79 lbs.
CRPL10-54	2144	Poly Top	54	72	24 3/4" x 35 1/8" x 32 5/8"	74 lbs.
CRSS10-72	2353	Stainless Steel Top	72	96	24 3/4" x 35 1/8" x 40 1/8"	63 lbs.
CRSS10-54	2323	Stainless Steel Top	54	72	24 3/4" x 35 1/8" x 32 5/8"	55 lbs.

ALUMINUM RACKS

Aluminum Pan Racks



Front Load

SPEC-LINE OVEN RACKS

Featuring High Temp Oven Plate Casters and All Welded Curved Top



- Heavy Duty Welded Construction
- 1" Square Tubing
- Curved Top
- 6 Cross Supports
- 4" Oven Plate Casters
- 1 1/2" Ribbed Angles

Model #	Price	Description	Pan Capacity	Shelf Spacing	Overall Size	Approx. Wt.
CFL20	\$2024	Front Load	20 Full or 40 Half Size	3"	20 1/4" x 26" x 68 5/8"	45 lbs.

Optional Accessories



Model #	Description	Price
RA-10	Pan Stop.....	\$319
RA-20	Track Pin.....	248
ORL-B	Oven Lift..... (For Front Load Pan Racks)	385

REACH-IN RACKS

- All Welded Construction
- 1" Square Tubing
- Holds up to 16 Full or 32 Half Size Pans
- 3" Shelf Spacing
- 1" Front and Rear Cross Bracing
- Shipped KD



Model #	Price	Pan Capacity	Shelf Spacing	Approx. Wt.
RR-16	\$1056	16 Full or 32 Half Size	3"	23 lbs.

Consult Factory For All Welded Reach-In Racks

BUS BOX RACK

- Heavy Duty Welded Construction
- Curved Top
- 5" Stem Bolted Casters
- Overall Size: 20 3/8" x 19" x 40 7/8"



Model #	Price	Bus Box Capacity	Approx. Wt.
BC3	\$831	3	18 lbs.

See Page 146
For Aluminum Bun Pans



SPECIALTY RACKS

Specialty Racks

PIZZA PAN & DOUGH RACKS



PDB7

- All Welded Construction
- Solid Aluminum Top
- 7 Box Capacity
- 3 3/4" Shelf Spacing
- 5" Poly Stem Bolted Casters
- 2" Wide Sides

18 1/8"



PDB14

- All Welded Construction
- No Top
- 14 Box Capacity
- 3 3/4" Shelf Spacing
- 4" Plate Casters
- 2" Wide Sides

18 1/4"

Model #	Price	Description	Overall Size	Approx. Wt.
PDB7	\$1813	Pizza Dough Box Rack (With Top)	26" x 20 1/4" x 33 3/4"	33 lbs.

Model #	Price	Description	Overall Size	Approx. Wt.
PDB14	\$2629	Pizza Dough Box Rack (No Top)	26" x 20 1/4" x 61 1/2"	63 lbs.

PR10-3WT Shown



HALF SIZE RACKS

- All Welded Construction
- 5" Poly Stem Bolted Casters
- 1-1/2" Ribbed Angles

PR7-4KT SERIES

- Removable Aluminum Top

PR7-4KT Shown



Model #	Price	Top	Description	Pan Capacity	Shelf Spacing	Overall Size	Approx. Wt.
PR7-4KT	\$1496	Aluminum Top	Front Load	7 Full/14 Half Size	3 3/4"	20 5/8" x 26 7/8" x 36"	28 lbs.
PR10-3WT	1562	Aluminum Top	Front Load	10 Full/20 Half Size	3"	20 1/4" x 26" x 38 1/2"	30 lbs.
PR10-3PT	1723	Poly Top	Front Load	10 Full/20 Half Size	3"	20 1/4" x 26" x 39"	45 lbs.
PR10-3ST	2031	Stainless Steel Top	Front Load	10 Full/20 Half Size	3"	20 1/4" x 26" x 39"	35 lbs.

*Top shelf spacing on the PR7-4KT is 2-1/8"

KEG RACKS

- 76" High, Aluminum Alloy Construction
- Shelves Are 1-3/4" Square Tubing
- 60 Lbs. Per Sq. Ft. Load Capacity Per Shelf
- Center Support Included On 93" Keg Shelves



Keg Rack Rear Strap

Prevents Kegs From Sliding Off Rear Of Keg Rack Shelf



Model #	Price	Size	# of Kegs (Per Unit)	Approx. Wt.
KR-42	\$1821	20" x 42"	4	50 lbs.
KR-60	1940	20" x 60"	6	66 lbs.
KR-72	2050	20" x 72"	8	80 lbs.
KR-80	2133	20" x 80"	8	88 lbs.
KR-93	2639	20" x 93"	10	100 lbs.

Model #	Price	Approx. Wt.
KR-1-42	\$213	6 lbs.
KR-1-60	237	7 lbs.
KR-1-72	239	8 lbs.
KR-1-80	265	9 lbs.
KR-1-93	288	10 lbs.

ALUMINUM RACKS

Specialty Racks

SPECIAL PURPOSE RACKS

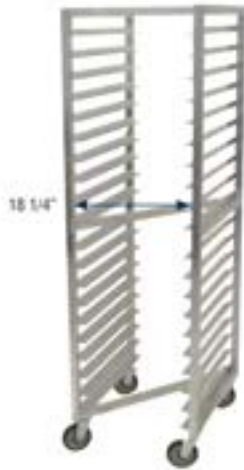

Nesting Pan Rack

SPACESAVING DESIGN

- Nested Design To Facilitate Maximum Storage in Minimum Space
- Heavy Duty Welded Construction With "Diagonal" Cross Supports
- 1 1/4" Square Tubing
- 1" X 1-1/2" Ribbed Angles
- Heavy Duty Stem Casters
- 500 Lb. Capacity



Steam Table Pan Rack

- Heavy Duty Welded Construction
- 1" Square Tubing
- Curved Top
- 6 Cross Supports
- 5" Poly Stem Bolted Casters



Model #	Price	Pan Capacity	Shelf Spacing	Overall Size	Approx. Wt.
NR-20	1795	20 Full or 40 Half Size	3"	21" x 26" x 69 1/4"	29 lbs.

Model #	Price	Pan Capacity	Shelf Spacing	Overall Size	Approx. Wt.
STR20-3W	\$1744	20 Full or 40 Half Size	3"	16 3/4" x 21 1/4" x 69 1/4"	34 lbs.



UNIVERSAL RACKS

- Heavy Duty Welded Construction
- 1-1/4" Square Tubing
- 6 Cross Supports
- Heavy Duty 5" Stem Bolted Casters
- Stepped Angles
- Overall Size: 26" x 26" x 69 1/4"
- Front Tray Load



TRAY RACKS

Holds Baking Pans, Steam Table Pans & Service Trays

- Heavy Duty Welded Construction
- 1-1/4" Square Tubing
- Heavy Duty 5" Poly Stem Bolted Casters
- 4" Wide Angles
- Overall Size: 26" x 26" x 69 1/4"
- Front Tray Load

Model #	Price	Pan Capacity	Shelf Spacing	Approx. Wt.
UR10	\$2360	10 Full or 20 Half Size	6"	86 lbs.
UR12	2440	12 Full or 24 Half Size	5"	100 lbs.

Model #	Price	Pan Capacity	Shelf Spacing	Approx. Wt.
OT20-3	2279	20 Full or 40 Half Size	3"	102 lbs.



LUG CARTS

- Heavy Duty Welded Construction
- 1" Square Tubing
- Curved Top
- 5" Stem Bolted Casters

Model #	Price	Lug Capacity	Overall Size L x W x H	Approx. Wt.
LR2	\$897	2	19" x 26" x 31 3/4"	18 lbs.
LR4	\$910	4	19" x 26" x 52 3/4"	21 lbs.
LR6	\$1012	6	19" x 26" x 69 3/4"	23 lbs.

BUN PANS

Bun Pans & Accessories



Look For Our Advertised
Specials on Sheet
Pan Pricing

ALUMINUM BUN PANS

- All Bun Pans Ship via UPS

Model #	Price	Size	Style	Gauge	Approx. Wt.
18-A-26	\$62 ea.	18" x 26"	Heavy Duty	16	43 lb.
18-8A-26	\$3 ea.	18" x 26"	Standard	18	40 lb.
18-8P-26	\$72 ea.	18" x 26"	Perforated	18	33 lb.
18-8A-13	\$44 ea.	18" x 13"	Half Size	18	24 lb.

**Packed One Dozen per Carton.
No splitting of CARTONS permitted.**

PAN RACK ACCESSORIES

All Pan Rack Accessories Ship via UPS



12" Tall
Vertical
Bumper



Stem Bolted
Caster



Oven Lift for Front Load
Pan Rack



Hi-temp
Oven
Plate
Caster



Plate
Caster



Bun Pan
Dolly
Caster



PRC-1



PRC-2

Bun Pan Rack Covers with 3 Zippers

PRC-1 Enclosed Heavy Duty Plastic Cover **\$435 ea.**
with Clear Front

PRC-2 Economy See-Thru Plastic Cover..... **\$321 ea.**

Model #	Description	Weight Capacity	Approx. Weight	Price
RA-10	Pan Stop	-	3 lbs.	\$319
RA-20	Track Pin	-	3 lbs.	248
RA-24	12" Vertical Bumpers (Set of 4)	-	-	212
RA-25	5" Stem Bolted Caster	125 lbs.	4 lbs.	78 ea.
RA-26	5" Stem Bolted Caster w/ Brake	125 lbs.	4 lbs.	92 ea.
RA-255V	5" Stem Bolted Caster for PR1803K, PR20-3K & PR12-5K ONLY	125 lbs.	4 lbs.	78 ea.
RA-265V	5" Stem Bolted Caster w/Brake for PR1803K, PR20-3K & PR12-5K ONLY	125 lbs.	4 lbs.	92 ea.
RA-30	4" Plate Caster w/ Built-in Zerk Grease Fitting	400 lbs.	4 lbs.	265 ea.
RA-35	4" Plate Caster w/ Brake	400 lbs.	4 lbs.	277 ea.
RA-40	4" Hi-temp Oven Plate Casters w/ Built-in Zerk Grease Fitting	300 lbs.	4 lbs.	188 ea.
RA-45	4" Hi-Temp Oven Plate Caster w/ Brake	300 lbs.	4 lbs.	206 ea.
RA-50	3" Bun Pan Dolly Caster	250 lbs.	-	85 ea.
RA-60	5" Heavy Duty Stem Caster for Universal & Oval Racks Only	300 lbs.	4 lbs.	123 ea.
RA-65	5" Heavy Duty Stem Caster with Brake for Universal & Oval Racks Only	300 lbs.	4 lbs.	136 ea.
ORL-8	18" Oven Lift For Front Load Pan Racks	-	1 lbs.	385 ea.

For Full Line of Aluminum Pan Racks,
See Page 141-145

www.advancetabco.com • customer@advancetabco.com

RACKS & CARTS

Racks & Carts

PAN TRUCK



- Heavy Duty Welded Construction
- 1" Square Tubing
- Curved Top
- Heavy Duty 3" Plate Casters
- Holds 60 Full Size Pans
- 600 lb. Weight Capacity



Model #	Price	Size	Approx. Wt.
PD-1	\$704	20" x 26 1/2" x 32"	20 lbs.

UTILITY CARTS

- 2 Chrome Plated Numbered Posts
- 3 Adjustable Stainless Steel Shelves with Tapered Split Sleeves
- 4 Swivel Casters (2 w/Brakes) & Donut Bumpers
- 150 lb. Load Capacity
- Shipped Knocked Down



Model #	Price	Size	Shelf Size	Approx. Wt.
UC-3-1827	\$1990	31 3/4" x 18" x 36 1/4"	18" x 27"	25 lbs.
UC-3-2433	\$2597	37 3/4" x 24" x 38 1/4"	24" x 33"	40 lbs.

GLASS RACK & PAN RACK DOLLIES

Bun Pan Dolly

- Heavy Duty Welded Construction
- 3" Plate Casters
- Holds 60 Full Size Pans
- 600 lb. Weight Capacity



Glass Rack Dolly

- Heavy Duty Welded Construction
- 3" Plate Casters
- 600 lb. Weight Capacity



Model #	Price	Description	Size	Approx. Wt.
BPD-1	\$758	Bun Pan Dolly	26 3/4" x 18 3/4" x 5"	15 lbs.
GRD-1	658	Glass Rack Dolly	20 1/2" x 20 1/2" x 5 1/4"	14 lbs.



Optional
Glass Rack Dolly Handle
(Assembly Required)
RA-14 \$638

ALUMINUM DUNNAGE RACKS

Stationary Dunnage Racks

8" & 12" Height Available



12" Height		8" Height		Size	# of Legs	Distribution Weight Capacity	Approx. Wt.
Model #	Price	Model #	Price				
DUN-2036	\$400	DUN-2036-8	\$400	20" x 36"	4	1500 lbs.	10 lbs.
DUN-2048	463	DUN-2048-8	463	20" x 48"	4	1800 lbs.	12 lbs.
DUN-2060	526	DUN-2060-8	526	20" x 60"	6	2000 lbs.	16 lbs.
DUN-2436	452	DUN-2436-8	452	24" x 36"	4	1500 lbs.	11 lbs.
DUN-2448	526	DUN-2448-8	526	24" x 48"	4	1800 lbs.	13 lbs.
DUN-2460	587	DUN-2460-8	587	24" x 60"	6	2000 lbs.	17 lbs.

Mobile Dunnage Racks

- Four 6" Plate Casters (2 Swivel, 2 Stationary)
- Includes Pull Handle For Easier Mobility
- 2000 Lb. Rolling Capacity



Now Includes Pull Handle

36" Height with Handle

Model #	Price	Size	Distribution Weight Capacity	Approx. Wt.
DUN-2036C	\$1069	20" x 36"	1500 lbs.	35 lbs.
DUN-2048C	1179	20" x 48"	1800 lbs.	40 lbs.
DUN-2060C	1373	20" x 60"	2000 lbs.	45 lbs.

SHELVING

Chrome & Green Epoxy Wire Shelving

All Items on This Page Ships via UPS

WIRE SHELVES 

Each Shelf Holds Up To 800 Lbs. Distributed Weight



	Shelf Size	CHROME	GREEN EPOXY	Price (Each)	Price (Set of 4)	Approx. Boxed Wt.	Boxed Cu. Ft.
14" WIDE	14" x 24"	EC-1424	EG-1424	90	360	35 lbs.	1.5
	14" x 30"	EC-1430	EG-1430	94	376	41 lbs.	2
	14" x 36"	EC-1436	EG-1436	100	400	47 lbs.	2.5
	14" x 42"	EC-1442	EG-1442	110	440	52 lbs.	3
	14" x 48"	EC-1448	EG-1448	121	484	58 lbs.	3.5
	14" x 60"	EC-1460	EG-1460	134	536	68 lbs.	4
18" WIDE	18" x 24"	EC-1824	EG-1824	99	396	39 lbs.	2
	18" x 30"	EC-1830	EG-1830	101	404	45 lbs.	2.5
	18" x 36"	EC-1836	EG-1836	110	440	51 lbs.	3
	18" x 42"	EC-1842	EG-1842	130	520	56 lbs.	3.5
	18" x 48"	EC-1848	EG-1848	134	536	64 lbs.	4
	18" x 54"	EC-1854	EG-1854	171	684	85 lbs.	5
21" WIDE	21" x 24"	EC-2124	EG-2124	105	420	42 lbs.	2.5
	21" x 30"	EC-2130	EG-2130	121	484	49 lbs.	3
	21" x 36"	EC-2136	EG-2136	131	524	56 lbs.	3.5
	21" x 42"	EC-2142	EG-2142	153	612	62 lbs.	4
	21" x 48"	EC-2148	EG-2148	164	656	70 lbs.	4.5
	21" x 54"	EC-2154	EG-2154	177	708	79 lbs.	5
24" WIDE	24" x 24"	EC-2424	EG-2424	120	480	44 lbs.	3
	24" x 30"	EC-2430	EG-2430	134	536	51 lbs.	3.5
	24" x 36"	EC-2436	EG-2436	150	600	58 lbs.	4
	24" x 42"	EC-2442	EG-2442	164	656	64 lbs.	5
	24" x 48"	EC-2448	EG-2448	176	704	72 lbs.	5.5
	24" x 54"	EC-2454	EG-2454	206	824	85 lbs.	6
	24" x 60"	EC-2460	EG-2460	215	860	88 lbs.	6.5
	24" x 72"	EC-2472	EG-2472	245	980	100 lbs.	7

24" To 48" Length Shelves Are Packed 4 To A Box And 54", 60" And 72" Shelves Are Packed 2 To A Box.
4 Pair Plastic Split Sleeves Are Included With Each Shelf.

POSTS FOR WIRE SHELVING

Posts Are Numbered

Post Height	Posts With Adjustable Foot				Posts For Casters (Casters Priced Separately)				Approx. Boxed Wt.	Approx. Cu. Ft.
	CHROME	GREEN EPOXY	Each	Set of 4	CHROME	GREEN EPOXY	Each	Set of 4		
14"	ECP-14	EGP-14	\$41	\$164	ECPC-14	EGPC-14	\$42	\$168	4 lbs.	.07
34"	ECP-34	EGP-34	54	216	ECPC-34	EGPC-34	54	216	8 lbs.	.18
54"	ECP-54	EGP-54	59	236	ECPC-54	EGPC-54	61	244	12 lbs.	.28
64"	ECP-64	EGP-64	64	256	ECPC-64	EGPC-64	69	276	15 lbs.	.33
74"	ECP-74	EGP-74	75	300	ECPC-74	EGPC-74	75	300	17 lbs.	.39
86"	ECP-86	EGP-86	90	360	ECPC-86	EGPC-86	90	360	20 lbs.	.45

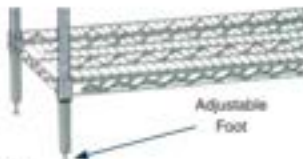

148

5" CASTERS

Sets Feature 4 - 5" Swivel Casters (2 w/ Brakes & 4 Donut Bumpers)

Casters For Wire Shelving Only. See Page 68 For Casters For Tables.



1000 lb. Max. Load Capacity For Shelving Casters

EC-25 Rubber Casters \$393 /set of 4

EC-26 Poly Casters 484 /set of 4

All Items on This Page Ships via UPS

SHELVING

Shelving Combos

CHROME & GREEN EPOXY WIRE SHELVING COMBOS



Includes 4 Wire Shelves And 4 - 74" Posts



Chrome



Green Epoxy

Chrome Model #	Green Epoxy Model #	Price	Shelf Size	Post Height	Approx. Wt.
ECC-1436	EGG-1436	700	14" x 36"	74"	64 lbs.
ECC-1442	EGG-1442	740	14" x 42"	74"	69 lbs.
ECC-1448	EGG-1448	784	14" x 48"	74"	75 lbs.
ECC-1460	EGG-1460	836	14" x 60"	74"	93 lbs.
ECC-1472	EGG-1472	1020	14" x 72"	74"	107 lbs.
ECC-1836	EGG-1836	740	18" x 36"	74"	68 lbs.
ECC-1842	EGG-1842	820	18" x 42"	74"	73 lbs.
ECC-1848	EGG-1848	836	18" x 48"	74"	81 lbs.
ECC-1854	EGG-1854	981	18" x 54"	74"	88 lbs.
ECC-1860	EGG-1860	1004	18" x 60"	74"	99 lbs.
ECC-1872	EGG-1872	1124	18" x 72"	74"	115 lbs.
ECC-2436	EGG-2436	900	24" x 36"	74"	75 lbs.
ECC-2442	EGG-2442	955	24" x 42"	74"	81 lbs.
ECC-2448	EGG-2448	1004	24" x 48"	74"	89 lbs.
ECC-2454	EGG-2454	1124	24" x 54"	74"	97 lbs.
ECC-2460	EGG-2460	1160	24" x 60"	74"	111 lbs.
ECC-2472	EGG-2472	1280	24" x 72"	74"	127 lbs.

MOBILE CARTS

Includes 4 Chrome Wire Shelves And 4 - 64" Posts

- 4 Swivel Casters (2 with Brakes & 4 Donut Bumpers)
- Finished Height of 70"
- Weight Capacity Not To Exceed 1000 lbs. Total Weight



w/ Rubber Casters		w/ Poly Casters		Shelf Size	Approx. Wt.
Model #	Price	Model #	Price		
MC-1836R	\$1109	MC-1836P	\$1200	18" x 36"	43 lbs.
MC-1848R	1205	MC-1848P	1296	18" x 48"	55 lbs.
MC-1860R	1373	MC-1860P	1464	18" x 60"	86 lbs.
MC-2436R	1269	MC-2436P	1360	24" x 36"	62 lbs.
MC-2448R	1373	MC-2448P	1464	24" x 48"	76 lbs.
MC-2460R	1529	MC-2460P	1620	24" x 60"	98 lbs.

FOR ADDITIONAL SHELVING, SEE PAGE 148

WIRE UTILITY CARTS

- 3 Chrome Wire Shelves
- Tubular Numbered Handles
- 12 Plastic Split Sleeves
- 32" Finished Height
- 4 - Swivel Casters (2 w/ Brakes & Donut Bumpers)



Rubber Casters		Poly Casters		Size	Approx. Wt.	Approx. Cu. Ft.
Model #	Price	Model #	Price			
WUC-1836R	\$979	WUC-1836P	\$1070	18" x 36"	53 lbs.	3
WUC-1842R	1039	WUC-1842P	1130	18" x 42"	55 lbs.	4
WUC-2436R	1137	WUC-2436P	1228	24" x 36"	58 lbs.	4
WUC-2442R	1179	WUC-2442P	1270	24" x 42"	61 lbs.	5

800 lb. Capacity 1000 lb. Capacity

UTILITY CART HANDLES

34" Tubular Numbered Posts (Fits EC-25 And EC-26 Casters)

Model #	Price	Width
UCH-18	\$128 ea.	18"
UCH-24	147 ea.	24"



SOLID STAINLESS STEEL SHELVES

Use With Chrome Posts Only (Posts Not Included)



Model #	Price	Width
SH-1824	\$439 ea.	18" x 24"
SH-1836	551 ea.	18" x 36"
SH-1842	590 ea.	18" x 42"
SH-1848	657 ea.	18" x 48"
SH-1860	794 ea.	18" x 60"

All Items on This Page Ships via UPS

WIRE SHELVING

Specialty Wire Shelving & Accessories

WALL SHELF MOUNTING BRACKETS

Single Mount Includes 2 Brackets & 4 Collar Filler Caps

Double Mount Includes 1 Bracket

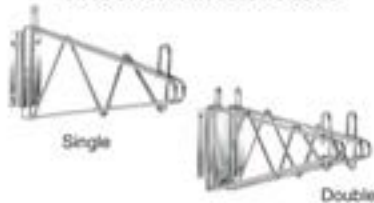

Chrome	Green Epoxy	Price	Size	Approx. Wt.
SINGLE BRACKET				
SB-14	GB-14	\$150	14"	2 lbs.
SB-18	GB-18	185	18"	3 lbs.
DOUBLE BRACKET (For Adjoining Shelves)				
DB-14	GDB-14	\$176	14"	3 lbs.
DB-18	GDB-18	229	18"	4 lbs.

WALL MOUNTED SHELVING SYSTEM

Mounting Hardware Included - Shelves Sold Separately

- End Mount Kit**
- 4 Single Shelf Brackets
 - 2 - 3/4" Posts
 - Collar Filler Caps

AB2-14 \$337 AB2-18 \$449
14" Wide 18" Wide

- Mid-Mount Kit**
- 2 Double Shelf Brackets
 - 1 - 3/4" Posts
 - For Adjoining Shelves

ABM2-14 \$233 ABM2-18 \$275
14" Wide 18" Wide

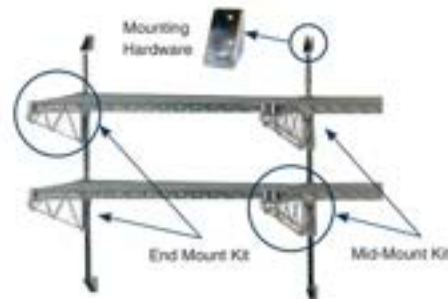

For Additional Tiers, Order Larger Posts On Page 150 With EC-90 Mounting Hardware For Each Post And Use The Following Brackets.

WALL MOUNTED SHELVING SYSTEM EXPANSION KITS

- Includes Adjustable Bracket(s)

2 Single End Mount Brackets

AAB-14 \$92
14" Wide

AAB-18 \$105
18" Wide

1 Double Mid-Mount Bracket

AABM-14 \$119
14" Wide

AABM-18 \$135
18" Wide

Mounting Hardware

- Includes 2 End Mounts & 1 Mid-Mount Per Post

EC-50 \$75

REPLACEMENT PARTS & ACCESSORIES



EC-5	Post Clamp	\$28 ea.
EC-10	Replacement Leveling Foot	19 ea.
EC-11	Foot Plate	26 ea.
EC-15	Chrome Collar Filler Caps	23 /pack
(For Add-Shelving and Wall Mounted Shelves - 4 per pack)		
EC-16	Plastic Post Cap (4 pair per pack)	20 /pack
EC-20	Tapered Split Sleeves (4 per pack)	23 /pack
EC-30	S Hooks for add-shelving (2 pair per pack)	34 /pack
EC-40	Black Label Holder (3" x 1")	34 ea.

CASTERS FOR WIRE SHELVING

5" Swivel Stem Casters (2 w/ Brakes & 4 - Donut Bumpers)

Load Capacity is 500 Lbs. Per Set.



Rubber

EC-25 \$393
Set of 4



Poly

EC-26 \$484
7Set of 4

THESE CASTERS ARE FOR WIRE SHELVING UNITS ONLY.

See Page 68 For S/S Worktable Casters.

ADVANCE TABCO WARRANTY

General Terms for all Advance Tabco Items (including those listed below):

- Warranty applies in the 48 contiguous United States only
- ALL WARRANTY WORK MUST BE AUTHORIZED BY THE FACTORY BEFORE ANY WORK IS PERFORMED. Work performed without prior authorization shall be covered under this warranty only at the sole discretion of Advance Tabco
- At no time will expenses to be paid under warranty exceed the original cost of the item
- Routine maintenance and wear items are not covered by warranty.
- Repair parts are sent by ground transportation. Any expedited freight charges will be at the expense of the end user
- Warranty applies only under conditions of normal use and does not apply to defects which result from negligence, misuse, freight damage, improper installation or accidents.
- Warranty does not include any coverage for loss of business, damages, freight or other miscellaneous expenses incurred due to the defect or in servicing the unit.
- This warranty is made in lieu of all other warranties express or implied and no additional warranties express or implied, including one of merchantability or fitness for a particular purpose are given.
- If defects are the result of **freight or handling damage** your first recourse MUST be to notify the delivering freight carrier of the damage. If possible any damage should be noted on the delivery receipt at the time of delivery. Defects due to freight damage should be referred to the freight carrier for correction and compensation (this applies regardless of who was responsible for paying the freight charges or selecting the carrier).
- **Hot Food and Refrigerated Tables and Drop-ins** are warranted for 12 months from the date of shipment from the factory or 6 months from the date first placed into service (whichever comes first) and include the following terms:
 - Applies only to parts directly related to the electric, gas or refrigeration components of covered items (see below for all other parts)
 - Covers parts and labor during the warranty period (refrigeration components include labor coverage for 12 months from date of shipment or 3 months from date placed into service, with parts covered as described above). Labor performed after hours, as overtime, on weekends or on holidays is not covered by this warranty (end user may authorize and pay such expenses directly to service agency if desired)
 - Includes travel up to 100 miles round trip or 2 hours of travel time (additional travel will be at the end users expense)
- **Refrigeration Compressors for Tables and Drop-ins are eligible for additional optional warranty coverage (if purchased):**
 - Must be purchased at the time the covered unit is ordered from the factory
 - Valid for 60 months from the date of shipment from the factory
 - Covers parts only (no labor, no freight). Applies only to the compressor unit.
 - Excludes the cost of refrigerant
- **Refrigerated underbar equipment (Glass Frosters, Bottle Coolers, Back Bar Refrigeration)** is warranted for 24 months from the date of shipment from the factory and includes the following terms:
 - Covers parts and labor during the warranty period. Labor performed after hours, as overtime, on weekends or on holidays is not covered by this warranty (end user may authorize and pay such expenses directly to service agency if desired)
 - Includes travel up to 100 miles round trip or 2 hours of travel time (additional travel will be at the end users expense)
 - Compressors only are warranted for a total of 60 months parts only (36 months parts after the initial 24 month parts and labor coverage)
- **Ware Washing Machines** are warranted for 12 months from the date of shipment from the factory and include the following terms:
 - Covers parts and labor during the warranty period. Labor performed after hours, as overtime, on weekends or on holidays is not covered by this warranty
 - Includes travel up to 100 miles round trip or 2 hours of travel time (additional travel will be at the end users expense)
 - Any repairs or service conducted other than by an authorized service agent will void this warranty
- **All Advance Tabco items not mentioned above (including parts not otherwise covered for hot food and refrigerated units)** are warranted free of defects in workmanship and materials for 90 days from the date of shipment from the factory. Warranty includes parts only (no labor). At Advance Tabco's discretion we may repair or replace the defective item.

TERMS & CONDITIONS

All previous prices and discounts are hereby withdrawn

- All prices are F.O.B. factory.
- All prices, specifications and discounts subject to change without notice. Prices listed herein do not include Federal Excise, Municipal or other use Tax.
- Orders that are shipped to an active construction site or residential address are subject to additional charges by the carrier. These charges may be applied after shipment.
- Not responsible for any damage while in hands of carrier. Inspect immediately for hidden damage. (For any damage and loss while in transit, promptly file claim against carrier.)
- Merchandise shipped open account to those firms furnishing satisfactory credit references. Terms are 1% Discount - 10 days; Net - 30 days.
- Quotations, unless otherwise stated, are for 60 day acceptance.
- Returns: A 30% handling charge will be applied to all authorized returns. **Minimum charge \$50.00 Equipment older than 90 days is not eligible for returns.**
- A 50% handling charge will be applied to all unauthorized returns.
- Orders for special items are not subject to cancellation without our written consent.
- Our consent must be obtained before defective merchandise is returned. Incoming freight or express charges may be collected and exchanged items will be shipped prepaid.
- On return shipments that we sanction, where orders have been correctly filled out and not defective, the incoming freight or express charges must be prepaid. Credit will then be issued, less a reasonable handling charge and less whatever expense is necessary to put goods in salable condition.
- We are not responsible for any delays in delivery which are beyond our control such as fires, strikes, delays in transportation or any contingencies of similar character.
- All orders subject to acceptance at our office.
- Possession of price list does not constitute an offer to sell.
- Minimum charge on all orders is \$50.00 NET.

GENERAL SHIPPING INFORMATION

1. We reserve the right to ship via carriers that in our opinion are the most efficient. We will follow customers routing if possible.
2. Unless specified, all orders shipped freight collect.
3. All "Drop Shipments" will be shipped "Prepaid & Charge".
4. Shipper is not responsible for any unauthorized accessorial charges. All charges will be billed back to customer.

PREPAID FREIGHT CHARGES

- Minimum UPS charge = \$20.00.
- Estimated freight charges added to an invoice will include a nominal administrative charge per freight bill.

ESTIMATED SHIPPING WEIGHTS ARE TO SERVE AS A GUIDE ONLY!

- Weights are averaged for all models within a given classification. Actual shipping weights may vary from those shown. Correct weight will be shown on your Bill of Lading.

This Price Guide Supersedes May 2022 Price Guide.





NATIONWIDE
STAINLESS STEEL FABRICATION



Customer Service Around The Country!

Corporate Headquarters: 325 Wireless Boulevard | Hauppauge | NY | 11788

National Manufacturing: Georgia² | Tennessee² | Texas² | Mississippi² | New York | Reno | South Carolina

