

UTILITY DISTRIBUTION SYSTEMS



**Powering your kitchen
in an organized, flexible way.**





Avtec Utility Distribution Sys

PREP LINES, COOK LINES, CHEF TA

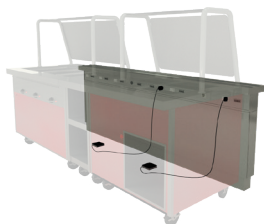

1. MDS-T: Serving Line Tray-Slide-Mounted UDS. Modular distribution system mounted to factory-built knee wall and tray slide unit, or contractor-built wall. All serving line components can be rolled in and plugged in for easy setup, installation and changing or replacing individual pieces.

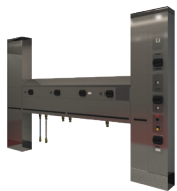

2. M-Series: Modular Wall or Island Mounted UDS. Available in 6" or 8" wide sizes with up to 150 amp, 120/208/3Ø electrical service, gas, water and steam.



3. EPO: Avtec Electrapole. This unit is capable of bringing 120/208/3Ø power to the middle of the room via plug-in connection in the ceiling. Available in 120/1Ø two-outlet, single circuit version, or 120/208/3Ø, multi-circuit version.



4. MOD: Overhead UDS. Perfect for getting accessible electrical connections of any voltage or phase to a work table. The minimal 4-1/2" x 6" cross section and utilizing removable extension cords when needed retain a clean look in the kitchen. Compressed air can also be designed into this model.



5. E-Series: Heavy-Duty Wall or Island Mounted UDS. Available in 8" or 12" wide sizes with any utility including 1000 amp electrical service, 120/208v, 480v, gas, water, steam, and condensate return.



6. MDS-C: Counter-Mounted UDS. Allows any amperage or voltage piece of equipment to be utilized on the work table, not just a couple of 120 outlets. A UL-Listed work table with a single connection!



7. MDS: Light-Duty, Wall-Mounted UDS. Perfect for wall-mounted counters, multiple mobile carts, vending machines, or work areas. An easy way to add electrical outlets to a walk-in wall.



8. UPO: Utility Pedestal. The Avtec utility pedestal allows for a sink in the middle of the room as well as power outlets. This is a perfect unit alongside a cutter/mixer in the prep area.



MOD: Modular Overhead. The overhead unit is perfect for areas where pass-through refrigerators are used, such as school cafeterias. No cords or floor electrical boxes to get in the way.



Items: Powering Your Kitchen

BLENDERS, SERVING LINES, DISHROOMS

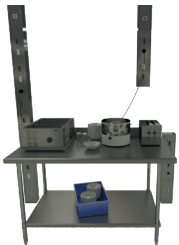

Additional Applications.

MDS: Modular Distribution System. The Avtec modular distribution system offers many ways to supply power for equipment items on a work table. The floor-to-ceiling power column can be designed alongside the table for easy access to outlet options. The power post can bring power up from the floor, and the power drop can bring power down from the ceiling.



MCO: Modular Conveyor-Mounted. The conveyor-mounted UDS is absolutely perfect for powering all of the ancillary equipment required on a tray make-up or banquet-plating application. One plug-in for all of the equipment needed!



DS: Modular Disconnect. The Avtec disconnect box (4DS shown) can be used as an on-the-spot disconnect for one, two, three, or four circuits at the point of use. In this case, a dish machine's motor, pump, booster heater and tank heater have a single point for all of the disconnect switches required.

Why an Avtec UDS?

There are **many utility connections necessary** to power and support commercial kitchen cooking equipment. How the connections are brought to the equipment can vary widely per project. Sometimes the result is a tangled mess of utility connections that are impossible to clean, inflexible, and very difficult to access for service.

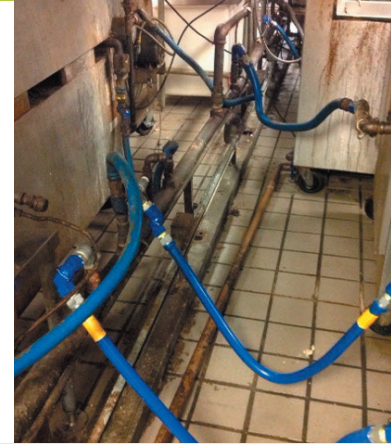

The **single-point connections for each utility and pre-wired, pre-plumbed Utility Distribution System is designed to have all of the necessary connections in one complete package.** Connections can be moved, added or changed at any time. The flexible and accommodating design eliminates the possibility of missed connections, charge-backs and job-site revisions. Set it in place, make minimal connections and you're ready to go. Coordination of the trades is made easier and staying on schedule is a snap.

In project design, the numerous **rough-in locations can be minimized.** The many necessary utility connections can be limited to one or two connections per utility. Missed or incorrect rough-in locations are eliminated. Errors or changes can be accommodated at any time during the process, even after installation.

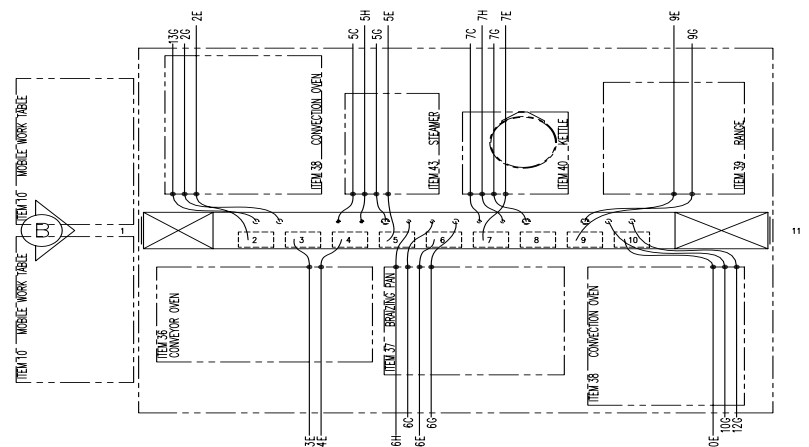
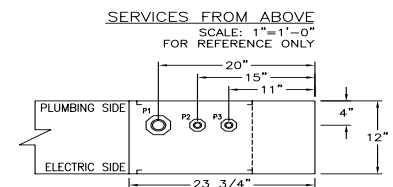
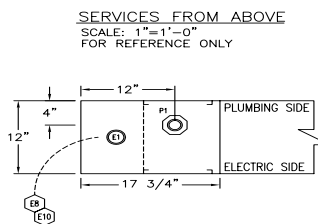

FLEXIBILITY. SAFETY. EXPANSION. SPEED.

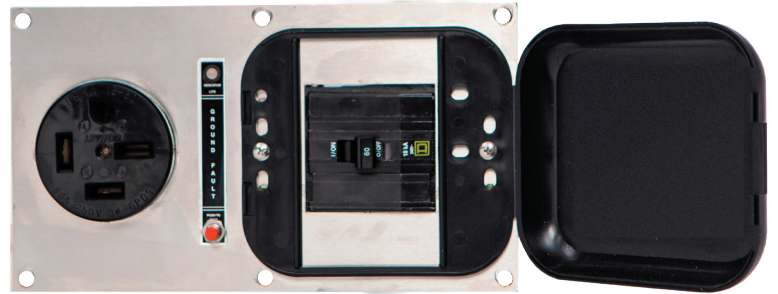

The **“point-of-use” breaker plate**, whether in the heavy-duty 5” x 9” version or the 4” x 12” modular version, is the heart of the Utility Distribution System. Since the circuit breaker and the matching outlet are on one plate, they travel together — whether to move, replace or add equipment. Each plate can be designed to accommodate any possible connection to serve the piece of equipment as needed.

A standard panel box has many limitations. Most panel boxes are sized with a limited number of breaker positions. Since some equipment — 208 volt single phase or three phase, for instance — requires up to three breaker positions, the panel is limited in the number of pieces of equipment it can service. The UDS can have **one, two, or three pole breaker positions**, which allows for much more flexibility and capacity.

Whether you choose the heavy-duty unit with bus bar or the modular unit with cable bus, the **120/208/3Ø service** allows you to easily add, move or change connection plates of any voltage or amperage with ease!



The heart of the system.

SAFETY. CONTROL. VISUAL MANAGEMENT.

1. Main Terminal Electrical Incoming Service Access Pane. This removable access panel allows access for the electrician to easily and safely bring the main power to the Avtec terminal lugs.

2. Main Service Breaker. This main breaker (up to 150 A, 102/208/3 in M-Series) allows manual control and shut-off of all electrical power to the UDS as well as being interconnected to the Avtec Fire Fuel shut-off system. Safety and control at the end of the cooking battery, even in the 6" or 8" wide version!

3. Incoming Plumbing Services. In the service tower, Avtec provides easy-to-access service piping for gas, water, steam, condensate return, or other required services. All incoming service connections are provided with the necessary shutoff valves, and in the case of gas, there is an electric gas solenoid valve for the Avtec gas delay shut-off system, pre-wired to the Fire Fuel shut-off circuit for complete shutdown in a fire condition.

4. Ventilator Light Switch. The switch for operating the hood lights is conveniently located at the end of the cooking line, and comes complete with its own circuit breaker for easy and safe use and service access. The switch comes pre-wired with a flexible connector for easy interconnection during installation.

5. Gas Delay Shut-Off System. Another Avtec innovation, the gas delay system, includes a built-in delay to prevent the gas valve from closing in "brown-out" conditions, as well as an audio alarm and visual light warning if the gas valve has closed. This would occur in a major power outage or fire condition. The gas valve can be easily reset by pushing the reset button. A good reminder that the necessary pilot lights need to be re-lit as well!

6. Remote Status Indicator Lights. Since the breaker plates for the E-series UDS are located below the horizontal housing in most cases, the remote status indicator lights give the operator visual notification as to the status of the individual breakers. A green light means the breaker is on and working. A red light means the breaker has tripped, and it's time to call for service. An LED that is not lit at all indicates you have a future breaker location that is not presently being utilized.

7. Duplex Convenience Outlet. This additional electrical outlet gives the operator an extra outlet at the end of the cooking line for plugging in cleaning equipment or whatever equipment may require temporary power. This GFCI outlet comes complete with its own dedicated circuit breaker for additional ease and safety of operation.



Built-in safety and control.



Whether in island style (as depicted) or wall mounted, Avtec towers allow for the perfect location for controls and safety features needed when powering the cooking battery.

Avtec provides the fire fuel shut-off, ventilator light switch and all necessary incoming shut-off valves to make installation easy, while affording safe operation and control for the operator.

Contact Avtec engineering for other possible control systems, including steam controls and ventilator control packages.



UDS Advantages:

- Often a lower initial cost vs. a contractor-built wall — additional electrical connections can easily be added for future adjustability.
- Flexibility. Changes to the cooking line are easily handled; mistakes or last-minute changes can be accommodated.
- Ease of installation and single-point connections. The UDS can install at the same time as the ventilation system, and the trades only need to run their respective single lines (less time, less cost).
- Very easy to clean cooking area. Use of flexible connectors allows for moving and cleaning easily.
- Keep control of your aisle space. Don't let the trades design your kitchen, or steal your aisle space or hood capture.
- Pre-engineered cooking, ventilation and UDS in one centrally located control panel.
- Eliminates the time-consuming task of coordinating design engineers, general contractors, and sub-contractors. Cuts installation time.
- Reduces back charges for changes.
- Life cycle cost depreciation — UDS is classified as a piece of kitchen equipment that can be depreciated over seven years as opposed to a contractor-built wall with a depreciation life of 31 years. Plus, it can be relocated.
- Fire system controls for all cooking equipment including the fuel shut-off valves can be located within the UDS. This can include the following:
 - Gas and electrical shut-off
 - Fire suppression system requirement
 - Main service breaker shunt
- Hood controls, water filters, etc. can be incorporated in the clean, stainless steel housing.