



**DOMESTIC
FOODSERVICE EQUIPMENT - SUPPLEMENTAL PRICE LIST**

**Curved Tempered Glass
Sneeze Guards for:
HL5 models,
GR5A(H)(L) models**

A sleek new addition to accessories, is the curved Sneeze Guards. These beauties enhance and protect food products. Made of curved, tempered glass with penciled and polished edges, 24" Deep by 4 1/8" High. The hardware is available in Black Anodized and Clear Anodized Hardware.



Optional Sneeze Guard with black Anodized hardware

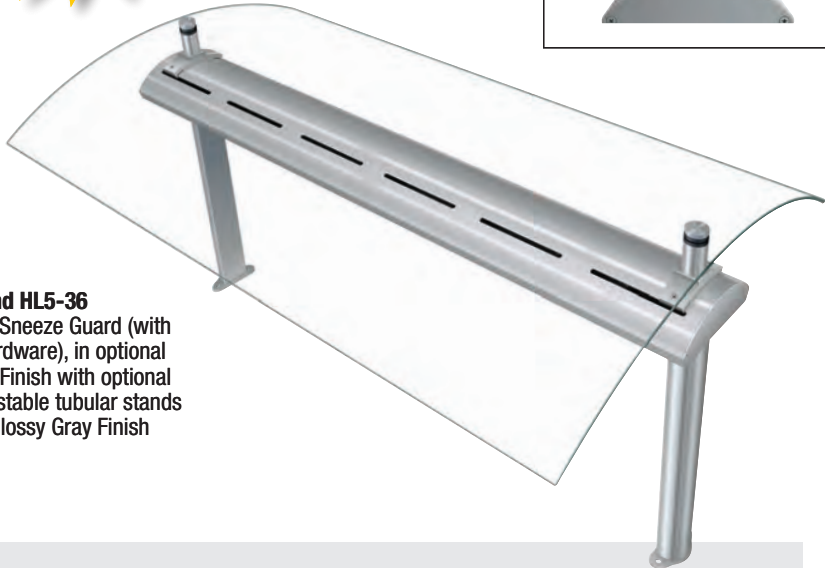
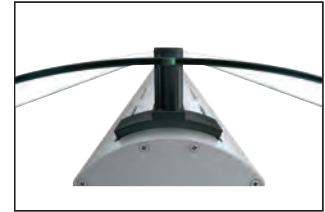

GR5A(H)(L)-36 and HL5-36 with new optional Sneeze Guard (with Clear Anodized hardware), in optional Glossy Gray Gloss Finish with optional 407 mm non-adjustable tubular stands (legs) in optional Glossy Gray Finish

HL5 ACCESSORIES (available for purchase at any time)

Curved tempered glass Sneeze Guard with penciled and polished edges for HL5 models – 24" D x 4 1/8" H

With Black Anodized hardware		With Clear Anodized hardware	
HL5-18-BA	Sneeze Guard fits HL5-18 models \$572	HL5-18-CA	Sneeze Guard fits HL5-18 models \$572
HL5-24-BA	Sneeze Guard fits HL5-24 models 583	HL5-24-CA	Sneeze Guard fits HL5-24 models 583
HL5-30-BA	Sneeze Guard fits HL5-30 models 600	HL5-30-CA	Sneeze Guard fits HL5-30 models 600
HL5-36-BA	Sneeze Guard fits HL5-36 models 622	HL5-36-CA	Sneeze Guard fits HL5-36 models 622
HL5-42-BA	Sneeze Guard fits HL5-42 models 688	HL5-42-CA	Sneeze Guard fits HL5-42 models 688
HL5-48-BA	Sneeze Guard fits HL5-48 models 715	HL5-48-CA	Sneeze Guard fits HL5-48 models 715
HL5-54-BA	Sneeze Guard fits HL5-54 models 732	HL5-54-CA	Sneeze Guard fits HL5-54 models 732
HL5-60-BA	Sneeze Guard fits HL5-60 models 781	HL5-60-CA	Sneeze Guard fits HL5-60 models 781
HL5-66-BA	Sneeze Guard fits HL5-66 models 798	HL5-66-CA	Sneeze Guard fits HL5-66 models 798
HL5-72-BA	Sneeze Guard fits HL5-72 models 814	HL5-72-CA	Sneeze Guard fits HL5-72 models 814

GR5A(H)(L) ACCESSORIES (available for purchase at any time)

Curved tempered glass Sneeze Guard with penciled, polished edges for GR5A(H), GR5A(H)L models only – 24" D x 4 1/8" H

With Black Anodized hardware		With Clear Anodized hardware	
SG5-18-BA	Sneeze Guard fits GR5A(H)(L)-18 models \$572	SG5-18-CA	Sneeze Guard fits GR5A(H)(L)-18 models \$572
SG5-24-BA	Sneeze Guard fits GR5A(H)(L)-24 models 583	SG5-24-CA	Sneeze Guard fits GR5A(H)(L)-24 models 583
SG5-30-BA	Sneeze Guard fits GR5A(H)(L)-30 models 600	SG5-30-CA	Sneeze Guard fits GR5A(H)(L)-30 models 600
SG5-36-BA	Sneeze Guard fits GR5A(H)(L)-36 models 622	SG5-36-CA	Sneeze Guard fits GR5A(H)(L)-36 models 622
SG5-42-BA	Sneeze Guard fits GR5A(H)(L)-42 models 688	SG5-42-CA	Sneeze Guard fits GR5A(H)(L)-42 models 688
SG5-48-BA	Sneeze Guard fits GR5A(H)(L)-48 models 715	SG5-48-CA	Sneeze Guard fits GR5A(H)(L)-48 models 715
SG5-54-BA	Sneeze Guard fits GR5A(H)(L)-54 models 732	SG5-54-CA	Sneeze Guard fits GR5A(H)(L)-54 models 732
SG5-60-BA	Sneeze Guard fits GR5A(H)(L)-60 models 781	SG5-60-CA	Sneeze Guard fits GR5A(H)(L)-60 models 781
SG5-66-BA	Sneeze Guard fits GR5A(H)(L)-66 models 798	SG5-66-CA	Sneeze Guard fits GR5A(H)(L)-66 models 798
SG5-72-BA	Sneeze Guard fits GR5A(H)(L)-72 models 814	SG5-72-CA	Sneeze Guard fits GR5A(H)(L)-72 models 814



Model ORBIT720 Flav-R-Shield™ Full-Service, Portable, Fully Adjustable Acrylic Sneeze Guards

Enhance and protect food products simultaneously with Hatco's Flav-R-Shield™ Sneeze Guards - ORBIT720 for portable and adjustable self-service applications. These stylish yet functional Sneeze Guards, with several patented features, are ideal for buffet lines and serving stations to safeguard your food.

- Unit is a single bay, portable model
- Patented 15° increment rotating Face Panel with clearances of:
 - To front: 2" to 22" from counter
 - To back: 13" to 24" from counter
- Mounting Post Height is adjustable up to 23" – based on pivoting Face and adjustable Post Bracket
- Stylish 1" Diameter SAE 304 brushed stainless steel Posts
- Durable 3/8" Thick tempered glass construction with 3/4" radius corners and flat polished edges for a clean look throughout (End Panels are 1/4" Thick)
- Stainless steel finish fixed Base is 1 1/2" Wide x 14" Deep

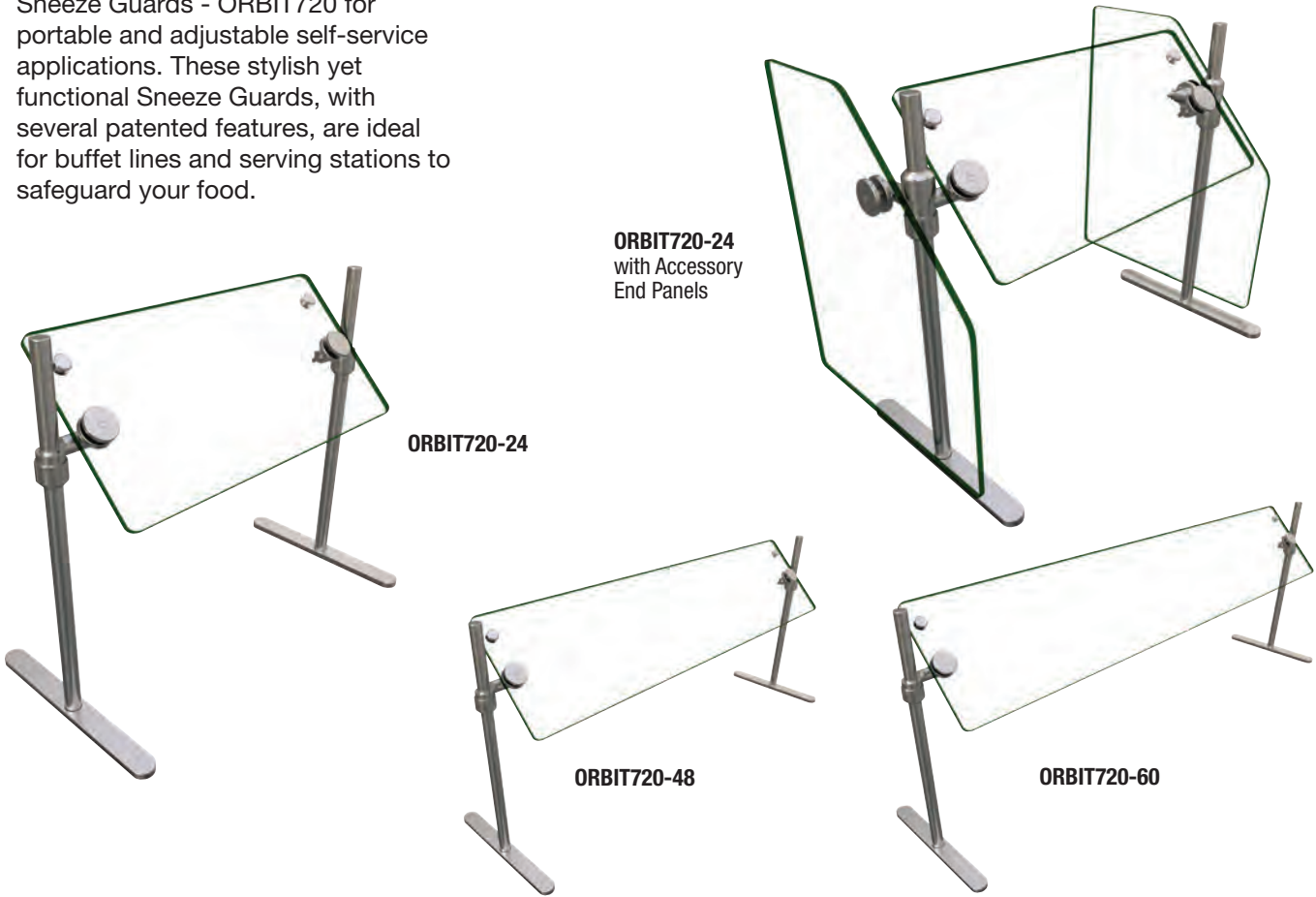

ORBIT720 SNEEZE GUARDS

Item Number	Number of Bays	Width Center of Post to center of Post	Depth of Base	Height (Based on pivoting Face and Adjustable Post Bracket)	Ship Weight [■]	List Price
ORBIT720-24	1	24"	14"	Up to 23"	27 lbs.	\$1428
ORBIT720-36	1	36"	14"	Up to 23"	44 lbs.	1512
ORBIT720-48	1	48"	14"	Up to 23"	55 lbs.	1644
ORBIT720-60	1	60"	14"	Up to 23"	77 lbs.	1815

■ Items may be shipped in multiple boxes.



Customize unit now!

Custom configurations available:
Hardware, glass, lighting and more!
Scan or click the QR code to the left.
www.hatcosneezeguards.com

ACCESSORIES (available for purchase at any time)

ORBIT720-EP Two 18" Deep x 21 9/16" High x 1/4" Thick tempered glass End Panels with hardware

\$924



**Model ORBIT100
Flav-R-Shield™
Full-Service, Pass-Over
Sneeze Guards**

Enhance and protect food products simultaneously with Hatco's Flav-R-Shield™ Sneeze Guards – ORBIT100 for pass-over applications. These stylish yet functional Sneeze Guards, with several patented features, are ideal for buffet lines and serving stations to safeguard your food.

- Patented 15° increment rotating Face Panel
- Face panel has additional circular openings for optimum Height adjustment
- Stylish 1" Diameter SAE 304 brushed stainless steel Posts

- Durable 3/8" thick tempered glass construction with 3/4" radius corners and flat polished edges for a clean look throughout
- Post Height is 18"
- Mounts to stainless steel, natural and engineered solid stone surfaces and laminate countertops



ORBIT100-36

Customizable features

- Post Height: 18" to 30"
- Face Panel: Widths 24" to 65 3/4" per Bay in 1/4" increments
- End Panel: Right only, left only or none, 18" to 65 3/4" Depths in 1/4" increments
- Flange options: Above or below counter compression
- Light Bar: Panel must be 18" Wide or Wider



Customize now!

Custom configurations available: Hardware, glass, lighting and more! Scan the QR code on left.

www.hatcosneezeguards.com

ORBIT100 SNEEZE GUARDS

Item Number	Number of Bays	Width Center of Post to center of Post	Depth End of Flange to edge of Panel	Height of Post	Approx. Ship Weight [■]	List Price
ORBIT100-36	1	36"	2.2"	18"	82 lbs.	\$1868
ORBIT100-48	2	48"	2.2"	18"	102 lbs.	2076
ORBIT100-60	2	60"	2.2"	18"	122 lbs.	2272
ORBIT100-72	2	72"	2.2"	18"	142 lbs.	3400
ORBIT100-84	2	84"	2.2"	18"	161 lbs.	3612
ORBIT100-96	3	96"	2.2"	18"	191 lbs.	3816
ORBIT100-108	3	108"	2.2"	18"	211 lbs.	4008
ORBIT100-120	3	120"	2.2"	18"	240 lbs.	4208
ORBIT100-132	4	132"	2.2"	18"	280 lbs.	4404
ORBIT100-144	4	144"	2.2"	18"	319 lbs.	5556

■ Items may be shipped in multiple boxes.

ACCESSORIES (available for purchase at any time)

ORBIT100-EP Two 18" Deep x 21 9/16" High x 1/4" Thick tempered glass End Panels with hardware

\$924



Model ORBIT360 Flav-R-Shield™ Self-Service, Fully Adjustable, Sneeze Guards

Enhance and protect food products simultaneously with Hatco's Flav-R-Shield™ Sneeze Guards – ORBIT360 for self-service applications. These stylish yet functional Sneeze Guards, with several patented features, are ideal for buffet lines and serving stations to safeguard your food.

- Patented 15° increment rotating Face Panel, perfect for radius counters
- Post Height is 23"
- Face panel has additional circular openings for optimum adjustment
- Stylish 1" Diameter SAE 304 brushed stainless steel Posts

- Durable 3/8" thick tempered glass construction with 3/4" radius corners and flat polished edges for a clean look throughout
- Mounts to stainless steel, natural and engineered solid stone surfaces and laminate countertops



ORBIT360-36

Customizable features

- Face Panel: Widths 24" to 65 3/4" per Bay in 1/4" increments
- End Panel: Right only, left only or none, 18" to 65 3/4" Depths in 1/4" increments
- Depths in 1/4" increments
- Flange options: Above or below counter compression
- Light Bar: Panel must be 18" Wide or Wider



Customize now!

Custom configurations available: Hardware, glass, lighting and more! Scan the QR code on left.

www.hatcosneezeguards.com

ORBIT360 SNEEZE GUARDS

Item Number	Number of Bays	Width Center of Post to center of Post	Depth	Height of Post	Approx. Ship Weight [■]	List Price
ORBIT360-36	1	36"	2" to 14"	23"	88 lbs.	\$1868
ORBIT360-48	2	48"	2" to 14"	23"	105 lbs.	3000
ORBIT360-60	2	60"	2" to 14"	23"	122 lbs.	3200
ORBIT360-72	2	72"	2" to 14"	23"	139 lbs.	3400
ORBIT360-84	2	84"	2" to 14"	23"	156 lbs.	3612
ORBIT360-96	3	96"	2" to 14"	23"	171 lbs.	3816
ORBIT360-108	3	108"	2" to 14"	23"	213 lbs.	4932
ORBIT360-120	3	120"	2" to 14"	23"	253 lbs.	5250
ORBIT360-132	4	132"	2" to 14"	23"	295 lbs.	6464
ORBIT360-144	4	144"	2" to 14"	23"	335 lbs.	6464

■ Items may be shipped in multiple boxes.

ACCESSORIES (available for purchase at any time)

ORBIT360-EP Two 18" Deep x 21 9/16" High x 1/4" Thick tempered glass End Panels with hardware

\$924



**Model ORBIT900
Flav-R-Shield™
Full-Service, Pass-over
Sneeze Guards**

Enhance and protect food products simultaneously with Hatco's Flav-R-Shield™ Sneeze Guards – ORBIT900 for pass-over applications. These stylish yet functional Sneeze Guards, with several patented features, are ideal for buffet lines and serving stations to safeguard your food.

- Patented 15° increment rotating Face Panel with clearances of 9" to 19", depending on angle
- Post Height is adjustable up to 23", based on pivoting Face and adjustable Post Bracket
- Durable 1/4" thick tempered glass construction with 3/4" radius corners and flat polished edges for a clean look throughout

- Face panel has additional circular openings for optimum adjustment
- Stylish 1" Diameter SAE 304 brushed stainless steel Posts
- Mounts to stainless steel, natural and engineered solid stone surfaces and laminate countertops

continued on next page...



ORBIT900-3618

Customizable features

- Face Panel: Widths 24" to 65 3/4" per Bay in 1/4" increments
- Top Glass: Orbit bracket
- End Panel: Right only, left only or none, in 18" to 65 3/4" Depths in 1/4" increments
- Flange options: Above or below counter compression
- Light Bar: Panel must be 18" Wide or Wider



Customize now!
Custom configurations available: Hardware, glass, lighting and more! Scan the QR code on left.

www.hatcosneezeguards.com



ORBIT900-07215



ORBIT900-10812



ORBIT900-14418

**ORBIT900 SNEEZE GUARDS**

Item Number	Number of Bays	Width Center of Post to center of Post	Depth Edge of Face to edge of End Panel	Adjustable Height	Ship Weight [■]	List Price
12" End Panels ◊						
ORBIT900-03612	1	36"	12"	Up to 23"	153 lbs.	\$3486
ORBIT900-04812	2	48"	12"	Up to 23"	159 lbs.	3888
ORBIT900-06012	2	60"	12"	Up to 23"	168 lbs.	5106
ORBIT900-07212	2	72"	12"	Up to 23"	178 lbs.	5510
ORBIT900-08412	2	84"	12"	Up to 23"	188 lbs.	5910
ORBIT900-09612	3	96"	12"	Up to 23"	215 lbs.	7534
ORBIT900-10812	3	108"	12"	Up to 23"	245 lbs.	7534
ORBIT900-12012	3	120"	12"	Up to 23"	270 lbs.	8134
ORBIT900-13212	4	132"	12"	Up to 23"	326 lbs.	9558
ORBIT900-14412	4	144"	12"	Up to 23"	353 lbs.	9558
15" End Panels ◊						
ORBIT900-03615	1	36"	15"	Up to 23"	159 lbs.	\$3670
ORBIT900-04815	2	48"	15"	Up to 23"	165 lbs.	4072
ORBIT900-06015	2	60"	15"	Up to 23"	173 lbs.	5290
ORBIT900-07215	2	72"	15"	Up to 23"	187 lbs.	5694
ORBIT900-08415	2	84"	15"	Up to 23"	196 lbs.	6094
ORBIT900-09615	3	96"	15"	Up to 23"	252 lbs.	7718
ORBIT900-10815	3	108"	15"	Up to 23"	268 lbs.	7718
ORBIT900-12015	3	120"	15"	Up to 23"	279 lbs.	8318
ORBIT900-13215	4	132"	15"	Up to 23"	335 lbs.	9742
ORBIT900-14415	4	144"	15"	Up to 23"	361 lbs.	9742
18" End Panels						
ORBIT900-03618	1	36"	18"	Up to 23"	162 lbs.	\$3670
ORBIT900-04818	2	48"	18"	Up to 23"	168 lbs.	4072
ORBIT900-06018	2	60"	18"	Up to 23"	176 lbs.	5290
ORBIT900-07218	2	72"	18"	Up to 23"	190 lbs.	5694
ORBIT900-08418	2	84"	18"	Up to 23"	199 lbs.	6094
ORBIT900-09618	3	96"	18"	Up to 23"	255 lbs.	7718
ORBIT900-10818	3	108"	18"	Up to 23"	271 lbs.	7718
ORBIT900-12018	3	120"	18"	Up to 23"	282 lbs.	8318
ORBIT900-13218	4	132"	18"	Up to 23"	338 lbs.	9742
ORBIT900-14418	4	144"	18"	Up to 23"	364 lbs.	9742

◊ Side panels may not meet NSF standards, see NSF guidelines for clarification.

■ Items may be shipped in multiple boxes.



**Model ED20
Flav-R-Shield™
Full Service, Pass-Over
Sneeze Guards**

Enhance and protect food products simultaneously with Hatco's Flav-R-Shield™ Sneeze Guards - ED20 for stationary full-service applications. These stylish yet functional Sneeze Guards, with several patented features, are ideal for buffet lines and serving stations. They provide all the requirements to safeguard your foods. Configurable glass mid-shelf is perfect for pizza display and desserts.

- Stylish 1" Diameter SAE 304 brushed stainless steel Posts
- 2" Diameter stainless steel finish Flanges with unique tight-fitting Flange Covers that hide mounting screws and maximize cleanability
- Durable 3/8" Thick tempered glass construction with 3/4" radius corners and flat polished edges for a clean look throughout

- Glass Face Panels, Top Shelf and two End Panels
- Unit mounts to stainless steel, natural and engineered solid stone

Customizable features

- Post Height: 12" to 30" in 1/4" increments
- Face Panel: Available in 8" to 54" per Bay in 0.25" increments
- End Panel: Right only, left only or none
- Shelves: 1 or 2
- Flange: Above or Below counter compression available
- Glass Corners: Square (Radius standard)
- Light Bar: Panel must be 18" Wide plus
- Post Finish: Powder coated black color

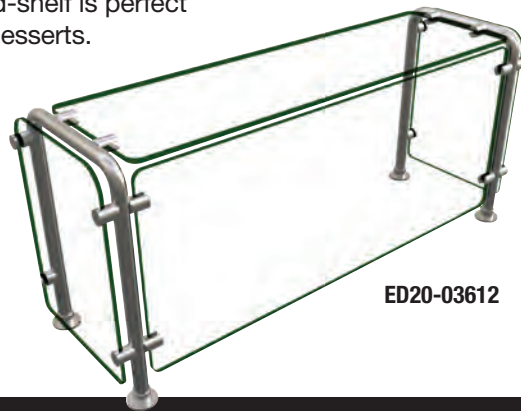

ED20-03612



Customize now!
Custom configurations available: Hardware, glass, lighting and more! Scan the QR code on left.

www.hatcosneezeguards.com

ED20 SNEEZE GUARDS

Item Number	Number of Bays	Width Center of Post to center Post	Depth Center of Post to center Post	Height	Ship Weight [■]	List Price
12" End Panels						
ED20-03612	1	36"	12"	18"	138 lbs.	\$3344
ED20-04812	1	48"	12"	18"	155 lbs.	3642
ED20-06012	2	60"	12"	18"	202 lbs.	4918
ED20-07212	2	72"	12"	18"	218 lbs.	5210
ED20-08412	2	84"	12"	18"	234 lbs.	5510
ED20-09612	2	96"	12"	18"	251 lbs.	5806
ED20-10812	2	108"	12"	18"	267 lbs.	6094
ED20-12012	2	120"	12"	18"	322 lbs.	7526
ED20-13212	3	132"	12"	18"	347 lbs.	7970
ED20-14412	3	144"	12"	18"	347 lbs.	7970
15" End Panels						
ED20-03615	1	36"	15"	18"	146 lbs.	\$3474
ED20-04815	1	48"	15"	18"	163 lbs.	3794
ED20-06015	2	60"	15"	18"	211 lbs.	5094
ED20-07215	2	72"	15"	18"	230 lbs.	5410
ED20-08415	2	84"	15"	18"	247 lbs.	5734
ED20-09615	2	96"	15"	18"	289 lbs.	6050
ED20-10815	2	108"	15"	18"	283 lbs.	6362
ED20-12015	2	120"	15"	18"	340 lbs.	7832
ED20-13215	3	132"	15"	18"	367 lbs.	8306
ED20-14415	3	144"	15"	18"	367 lbs.	8306
18" End Panels						
ED20-03618	1	36"	18"	18"	155 lbs.	\$3634
ED20-04818	1	48"	18"	18"	174 lbs.	3974
ED20-06018	2	60"	18"	18"	234 lbs.	5230
ED20-07218	2	72"	18"	18"	244 lbs.	5642
ED20-08418	2	84"	18"	18"	263 lbs.	5982
ED20-09618	2	96"	18"	18"	282 lbs.	6322
ED20-10818	2	108"	18"	18"	302 lbs.	6650
ED20-12018	2	120"	18"	18"	361 lbs.	8160
ED20-13218	3	132"	18"	18"	390 lbs.	8670
ED20-14418	3	144"	18"	18"	390 lbs.	8670

◇ 2" long #8 counter sink screws are recommended for installations on most surfaces. Requirements will vary based on surface material and thickness. Fasteners not included.

■ Items may be shipped in multiple boxes.



Model EP5 Flav-R-Shield™ Full-Service, Pass-Over Sneeze Guards

Enhance and protect food products simultaneously with Hatco's Flav-R-Shield™ Sneeze Guards - EP5 for stationary full-service applications. These stylish yet functional Sneeze Guards, with several patented features, are ideal for buffet lines and serving stations. They provide all the requirements to safeguard your foods.

- Stylish 1" Diameter SAE 304 brushed stainless steel Posts
- 2" Diameter stainless steel finish Flanges with unique tight-fitting Flange Covers that hide mounting screws and maximize cleanability
- Glass Face Panel and two 18" Deep glass End Panels to meet NSF standards
- Durable 1/4" Thick tempered glass construction with 3/4" radius corners and flat polished edges for a clean look throughout
- Mounts to stainless steel, natural and engineered solid stone surfaces and laminate countertops



EP5-36



EP5-60



EP5-96



EP5-132

EP5 SNEEZE GUARDS

Item Number	Number of Bays	Width Center of Post to center of Post	Depth Center of Post to center of Post	Height	Ship Weight [■]	List Price
EP5-36	1	36"	18"	25"	69 lbs.	\$2318
EP5-48	2	48"	18"	25"	84 lbs.	2896
EP5-60	2	60"	18"	25"	91 lbs.	3036
EP5-72	2	72"	18"	25"	97 lbs.	3172
EP5-84	2	84"	18"	25"	102 lbs.	3316
EP5-96	3	96"	18"	25"	126 lbs.	4026
EP5-108	3	108"	18"	25"	141 lbs.	4026
EP5-120	3	120"	18"	25"	157 lbs.	4242
EP5-132	4	132"	18"	25"	172 lbs.	4880
EP5-144	4	144"	18"	25"	187 lbs.	4880

◇ 2" long #8 counter sink screws are recommended for installations on most surfaces. Requirements will vary based on surface material and thickness. Fasteners not included.

■ Items may be shipped in multiple boxes.



Customize unit now!

Custom configurations available:
Hardware, glass, lighting and more!
Scan or click the QR code to the left.
www.hatcosneezeguards.com



**Model EP5-RING
Flav-R-Shield™
Full-Service, Pass-Over
Sneeze Guards**

Enhance and protect food products simultaneously with Hatco's Flav-R-Shield™ Sneeze Guards – EP5-RING for stationary full-service applications. These stylish yet functional Sneeze Guards, with several patented features, are ideal for buffet lines and serving stations. They provide all the requirements to safeguard your foods.

- Patented Ring Adjustable Brackets have locking points every 15°
- Stylish 1" Diameter SAE 304 brushed stainless steel Posts
- 2" Diameter stainless steel finish Flanges with unique tight-fitting Flange Covers that hide mounting screws and maximize cleanability
- Durable 1/4" Thick tempered glass construction with 3/8" radius corners and flat polished edges for a clean look

- Glass Face Panel and two 18" Deep glass End Panels
- Mounts to stainless steel, natural and engineered solid stone surfaces and laminate countertops

Customizable features

- Post Height: 8" to 42" in 1/4" increments
- Face Panel Width: 8" to 54" per Bay in 1/4" increments
- End Panel: Available in Depths of 8" to 54" in 1/4" increments
- Frosted Glass
- Flanges: Above or Below counter compression available
- Square cornered Panels
- Light Bar: Panel must be 18" Wide plus
- Post Finish: Powder coated black, brushed aluminum
- Adjustable Brackets (for radius corner glass only)
- Arc Glass: Full, curved or random arc with 2", 4" or 6" arc radius
- Mailbox Cutout: In 1/4" increments, for Panel Widths greater than 22" only



EP5-RING-36



Customize now!

Custom configurations available: Hardware, glass, lighting and more! Scan the QR code on left.

www.hatcosneezeguards.com

EP5-RING SNEEZE GUARDS

Item Number	Number of Bays	Width Center of Post to center Post	Depth Center of Post to center Post	Height	Ship Weight [■]	List Price
EP5-RING-36	1	36"	18"	25"	84 lbs.	\$3182
EP5-RING-48	2	48"	18"	25"	91 lbs.	4048
EP5-RING-60	2	60"	18"	25"	97 lbs.	4188
EP5-RING-72	2	72"	18"	25"	101 lbs.	4324
EP5-RING-84	2	84"	18"	25"	125 lbs.	4468
EP5-RING-96	3	96"	18"	25"	125 lbs.	5466
EP5-RING-108	3	108"	18"	25"	132 lbs.	5466
EP5-RING-120	3	120"	18"	25"	156 lbs.	5682
EP5-RING-132	4	132"	18"	25"	154 lbs.	6608
EP5-RING-144	4	144"	18"	25"	154 lbs.	6608

◇ 2" long #8 counter sink screws are recommended for installations on most surfaces. Requirements will vary based on surface material and thickness. Fasteners not included.

■ Items may be shipped in multiple boxes.



Model EP11 Flav-R-Shield™ Full-Service, Pass-Over Sneeze Guards

Enhance and protect food products simultaneously with Hatco's Flav-R-Shield™ Sneeze Guards - EP11 for stationary full-service applications. These stylish yet functional Sneeze Guards, with several patented features, are ideal for buffet lines and serving stations, providing the requirements to safeguard your foods.

- Stylish 1" Diameter SAE 304 brushed stainless steel Posts
- 2" Diameter stainless steel finish Flanges with unique tight-fitting Flange Covers that hide mounting screws and maximize cleanability
- Durable tempered glass construction with 3/4" radius corners and flat polished edges for a clean look throughout
- 1/4" Thick glass Face Panels and two 18" Deep glass End Panels

- 3/8" Thick, 11 1/2" Deep glass Top Shelf
- Unit's 17 1/4" Height is ADA compliant for counter surfaces up to 36" from the floor
- Mounts to stainless steel, natural and engineered solid stone surfaces and laminate countertops

Customizable features

- Post Height: 12" to 24" in 1/4" increments
- Face Panel: Available in 8" to 54" per Bay in 1/4" increments
- End Panel: Right only, left only or none
- Flange: Above or Below counter compression available
- Glass Corners: Square (Radius standard)
- Light Bar: Panel must be 18" Wide plus
- Post Finish: Powder coated black color
- Adjustable Brackets (for radius corner glass only)

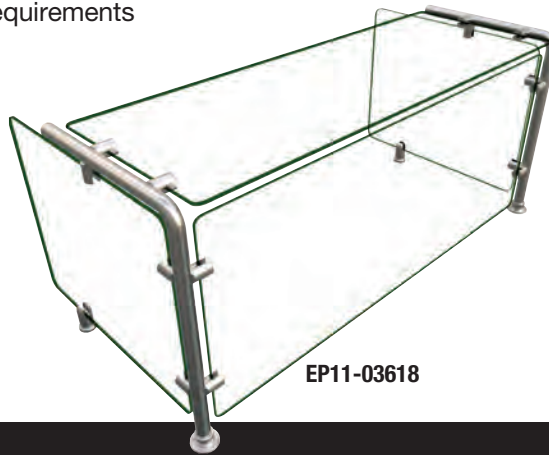

EP11-03618



Customize now!
Custom configurations available: Hardware, glass, lighting and more! Scan the QR code on left.

www.hatcosneezeguards.com

EP11 SNEEZE GUARDS

Item Number	Number of Bays	Width Center of Post to center of Post	Depth Center of Post to end of glass‡	Height	Ship Weight■	List Price
11 1/2" End Panels						
EP11-03612	1	36"	11"	17 1/4"	37 lbs.	\$2082
EP11-04812	1	48"	11"	17 1/4"	46 lbs.	3016
EP11-06012	2	60"	11"	17 1/4"	54 lbs.	3208
EP11-07212	2	72"	11"	17 1/4"	63 lbs.	3404
EP11-08412	2	84"	11"	17 1/4"	72 lbs.	3592
EP11-09612	2	96"	11"	17 1/4"	81 lbs.	4726
EP11-10812	2	108"	11"	17 1/4"	90 lbs.	4726
EP11-12012	3	120"	11"	17 1/4"	98 lbs.	5008
EP11-13212	3	132"	11"	17 1/4"	107 lbs.	6048
EP11-14412	3	144"	11"	17 1/4"	116 lbs.	6048
15" End Panels						
EP11-03615	1	36"	15"	17 1/4"	39 lbs.	\$2182
EP11-04815	1	48"	15"	17 1/4"	48 lbs.	3116
EP11-06015	2	60"	15"	17 1/4"	57 lbs.	3308
EP11-07215	2	72"	15"	17 1/4"	65 lbs.	3504
EP11-08415	2	84"	15"	17 1/4"	74 lbs.	3692
EP11-09615	2	96"	15"	17 1/4"	83 lbs.	4826
EP11-10815	2	108"	15"	17 1/4"	92 lbs.	4826
EP11-12015	3	120"	15"	17 1/4"	101 lbs.	5108
EP11-13215	3	132"	15"	17 1/4"	109 lbs.	6148
EP11-14415	3	144"	15"	17 1/4"	118 lbs.	6148
18" End Panels						
EP11-03618	1	36"	18"	17 1/4"	41 lbs.	\$2282
EP11-04818	1	48"	18"	17 1/4"	50 lbs.	3216
EP11-06018	2	60"	18"	17 1/4"	59 lbs.	3408
EP11-07218	2	72"	18"	17 1/4"	67 lbs.	3604
EP11-08418	2	84"	18"	17 1/4"	76 lbs.	3792
EP11-09618	2	96"	18"	17 1/4"	85 lbs.	4926
EP11-10818	2	108"	18"	17 1/4"	94 lbs.	4926
EP11-12018	3	120"	18"	17 1/4"	103 lbs.	5208
EP11-13218	3	132"	18"	17 1/4"	111 lbs.	6248
EP11-14418	3	144"	18"	17 1/4"	120 lbs.	6248

✦ 2" long #8 counter sink screws are recommended for installations on most surfaces. Requirements will vary based on surface material and thickness. Fasteners not included.

‡ Side Panels include back support legs.

■ Items may be shipped in multiple boxes.



**Model EP12
Flav-R-Shield™
Full-Service, Pass-Over
Sneeze Guards**

Enhance and protect food products simultaneously with Hatco's Flav-R-Shield™ Sneeze Guards – EP12 for stationary full-service applications. These stylish yet functional Sneeze Guards, with several patented features, are ideal for buffet lines and serving stations.

- Stylish Posts are 1" Diameter SAE 304 brushed stainless steel
- 2" Diameter stainless steel finish Flanges with unique tight-fitting Flange Covers that hide mounting screws and maximize cleanability
- Durable 1/4" Thick tempered glass construction with 3/4" radius corners and flat polished edges for a clean look
- Unit Height is 17 1/4"
- Glass Face Panels, 11 1/2" Top Shelf and two End Panels
- 18" Deep End Panels required to meet NSF standards

- End Panels Depths offered: 1 1/2", 15", 18"
- Unit mounts to stainless steel, natural and engineered solid stone surfaces and laminate countertops

Customizable features

- Post Height: Available 12" to 24" in 1/4" increments
- Face Panel: Available in 8" to 42" per Bay in 1/4" increments
- End Panel: Right only, left only or none
- Flange: Above or Below counter compression available
- Glass Corners: Square (Radius standard)
- Light Bar: Panel must be 18" Wide plus
- Post Finish: Powder coated black color
- Adjustable Brackets (for radius corner glass only)



EP12-03618



Customize now!

Custom configurations available: Hardware, glass, lighting and more! Scan the QR code on left.

www.hatcosneezeguards.com

EP12 SNEEZE GUARDS

Item Number	Number of Bays	Width Center of Post to center of Post	Depth Center of Post to end of glass†	Height	Ship Weight‡	List Price
11 1/2" End Panels ◊						
EP12-03612	1	36"	11"	17 1/4"	39 lbs.	\$2358
EP12-04812	1	48"	11"	17 1/4"	51 lbs.	\$292
EP12-06012	2	60"	11"	17 1/4"	57 lbs.	\$484
EP12-07212	2	72"	11"	17 1/4"	64 lbs.	\$680
EP12-08412	2	84"	11"	17 1/4"	70 lbs.	\$868
EP12-09612	2	96"	11"	17 1/4"	90 lbs.	\$1002
EP12-10812	2	108"	11"	17 1/4"	90 lbs.	\$1002
EP12-12012	3	120"	11"	17 1/4"	100 lbs.	\$1284
EP12-13212	3	132"	11"	17 1/4"	114 lbs.	\$1624
EP12-14412	3	144"	11"	17 1/4"	114 lbs.	\$1624
15" End Panels ◊						
EP12-03615	1	36"	15"	17 1/4"	41 lbs.	\$2870
EP12-04815	1	48"	15"	17 1/4"	53 lbs.	\$380
EP12-06015	2	60"	15"	17 1/4"	60 lbs.	\$3996
EP12-07215	2	72"	15"	17 1/4"	67 lbs.	\$4192
EP12-08415	2	84"	15"	17 1/4"	72 lbs.	\$4380
EP12-09615	2	96"	15"	17 1/4"	92 lbs.	\$5514
EP12-10815	2	108"	15"	17 1/4"	92 lbs.	\$5514
EP12-12015	3	120"	15"	17 1/4"	102 lbs.	\$5796
EP12-13215	3	132"	15"	17 1/4"	116 lbs.	\$6836
EP12-14415	3	144"	15"	17 1/4"	116 lbs.	\$6836
18" End Panels						
EP12-03618	1	36"	18"	17 1/4"	43 lbs.	\$2870
EP12-04818	1	48"	18"	17 1/4"	55 lbs.	\$3804
EP12-06018	2	60"	18"	17 1/4"	62 lbs.	\$3996
EP12-07218	2	72"	18"	17 1/4"	69 lbs.	\$4192
EP12-08418	2	84"	18"	17 1/4"	74 lbs.	\$4380
EP12-09618	2	96"	18"	17 1/4"	94 lbs.	\$5514
EP12-10818	2	108"	18"	17 1/4"	94 lbs.	\$5514
EP12-12018	3	120"	18"	17 1/4"	104 lbs.	\$5796
EP12-13218	3	132"	18"	17 1/4"	118 lbs.	\$6836
EP12-14418	3	144"	18"	17 1/4"	118 lbs.	\$6836

◊ 2" (50 mm) long #8 counter sink screws recommended for installations on most surfaces. Requirements vary based on surface material and thickness. Fasteners not included.

◊ Side panels may not meet NSF standards, see NSF guidelines for clarification.

■ Items may be shipped in multiple boxes.



Model EP36 Flav-R-Shield™ Full-Service, Pass-Over Sneeze Guards

Enhance and protect food products simultaneously with Hatco's Flav-R-Shield™ Sneeze Guards - EP36 for stationary full-service applications. These stylish yet functional Sneeze Guards, with several patented features, are ideal for buffet lines and serving stations. They provide all the requirements to safeguard your foods.

- Stylish 1" Diameter SAE 304 brushed stainless steel Posts
- 2" Diameter stainless steel finish Flanges with unique tight-fitting Flange Covers that hide mounting screws and maximize cleanability
- Durable 1/4" Thick tempered glass construction with 3/4" radius corners and flat polished edges for a clean look throughout
- Glass Face Panel and two 18" Deep glass End Panels
- Mounts to stainless steel, natural and engineered solid stone surfaces and laminate countertops



EP36-36



EP36-48



EP36-60

EP36 SNEEZE GUARDS

Item Number	Number of Bays	Width Center of Post to center of Post	Depth Center of Post to end of glass ‡	Height	Ship Weight■	List Price
EP36-36	1	36"	18"	22 1/8"	32 lbs.	\$2937
EP36-48	2	48"	18"	22 1/8"	41 lbs.	4150
EP36-60	2	60"	18"	22 1/8"	48 lbs.	4378

◇ 2" long #8 counter sink screws are recommended for installations on most surfaces. Requirements will vary based on surface material and thickness. Fasteners not included.

‡ Side Panels include back support legs.

■ Items may be shipped in multiple boxes.

Customize unit now!

Custom configurations available:
Hardware, glass, lighting and more!
Scan or click the QR code to the left.
www.hatcosneezeguards.com





**Model EP22
Flav-R-Shield™
Full-Serve, Pass-Over
Sneeze Guards**

Enhance and protect food products simultaneously with Hatco's Flav-R-Shield™ Sneeze Guards – EP22 for stationary full-service applications. These stylish yet functional Sneeze Guards, with several patented features, are ideal for buffet lines and serving stations.

- Stylish Posts are 1" Diameter SAE 304 brushed stainless steel - front Posts are tilted back to an 80° angle
- 2" Diameter stainless steel finish Flanges with unique tight-fitting Flange Covers that hide mounting screws and maximize cleanability
- Durable 1/4" Thick tempered glass construction with 3/4" radius corners and flat polished edges for a clean look

- Glass Face Panels, 11 1/2" Top Shelf and two End Panels
- 18" Deep End Panels required to meet NSF standards
- End Panels Depths offered: 11 1/2", 15", 18"
- Unit mounts to stainless steel, natural and engineered solid stone surfaces and laminate countertops



EP22-03618

EP22 SNEEZE GUARDS

Item Number	Number of Bays	Width Center of Post to center of Post	Depth Center of Post to center of Post	Height	Ship Weight [■]	List Price
12" End Panels ◊						
EP22-03612	1	36"	11 1/2"	17 1/4"	39 lbs.	\$2426
EP22-04812	2	48"	11 1/2"	17 1/4"	45 lbs.	3404
EP22-06012	2	60"	11 1/2"	17 1/4"	54 lbs.	3596
EP22-07212	2	72"	11 1/2"	17 1/4"	63 lbs.	3792
EP22-08412	2	84"	11 1/2"	17 1/4"	69 lbs.	3980
EP22-09612	3	96"	11 1/2"	17 1/4"	90 lbs.	5158
EP22-10812	3	108"	11 1/2"	17 1/4"	90 lbs.	5158
EP22-12012	3	120"	11 1/2"	17 1/4"	99 lbs.	5440
EP22-13212	4	132"	11 1/2"	17 1/4"	116 lbs.	6524
EP22-14412	4	144"	11 1/2"	17 1/4"	114 lbs.	6524
15" End Panels ◊						
EP22-03615	1	36"	15"	17 1/4"	41 lbs.	\$2870
EP22-04815	2	48"	15"	17 1/4"	47 lbs.	3848
EP22-06015	2	60"	15"	17 1/4"	56 lbs.	4040
EP22-07215	2	72"	15"	17 1/4"	65 lbs.	4236
EP22-08415	2	84"	15"	17 1/4"	71 lbs.	4424
EP22-09615	3	96"	15"	17 1/4"	92 lbs.	5602
EP22-10815	3	108"	15"	17 1/4"	92 lbs.	5602
EP22-12015	3	120"	15"	17 1/4"	101 lbs.	5884
EP22-13215	4	132"	15"	17 1/4"	118 lbs.	6968
EP22-14415	4	144"	15"	17 1/4"	116 lbs.	6968
18" End Panels						
EP22-03618	1	36"	18"	17 1/4"	43 lbs.	\$2870
EP22-04818	2	48"	18"	17 1/4"	49 lbs.	3848
EP22-06018	2	60"	18"	17 1/4"	58 lbs.	4040
EP22-07218	2	72"	18"	17 1/4"	67 lbs.	4236
EP22-08418	2	84"	18"	17 1/4"	73 lbs.	4424
EP22-09618	3	96"	18"	17 1/4"	94 lbs.	5602
EP22-10818	3	108"	18"	17 1/4"	94 lbs.	5602
EP22-12018	3	120"	18"	17 1/4"	103 lbs.	5884
EP22-13218	4	132"	18"	17 1/4"	120 lbs.	6968
EP22-14418	4	144"	18"	17 1/4"	118 lbs.	6968

Customizable features

- Face Panel: Available in 8" to 42" per Bay in 1/4" increments
- End Panel: Right only, left only or none
- Flange: Above or Below counter compression available
- Glass Corners: Square (Radius standard)
- Light Bar: Panel must be 18" Wide or Wider
- Post Finish: Powder coated black color
- Adjustable Brackets (for radius corner glass only)



Customize now!

Custom configurations available: Hardware, glass, lighting and more! Scan the QR code on left.

www.hatcosneezeguards.com

◊ Side panels may not meet NSF standards, see NSF guidelines for clarification.

■ Items may be shipped in multiple boxes.



Model EP21 Flav-R-Shield™ Full-Service, Pass-over Sneeze Guards

Enhance and protect food products simultaneously with Hatco's Flav-R-Shield™ Sneeze Guards – ED21 for stationary full-service applications. These stylish yet functional Sneeze Guards, with several patented features, are ideal for buffet lines and serving stations. They provide all the requirements to safeguard your foods.



- Stylish Posts are 1" Diameter SAE 304 brushed stainless steel - front Posts are tilted back to an 80° angle
- 2" Diameter stainless steel finish Flanges with unique tight-fitting Flange Covers that hide mounting screws and maximize cleanability
- Durable 1/4" Thick tempered glass with 0.75" radius corners and flat polished edges for a clean look
- Glass Face Panels, 11 1/2" Top Shelf and two End Panels
- 18" Deep End Panels required to meet NSF standards
- End Panels Depths offered: 11 1/2", 15", 18"
- Unit mounts to stainless steel, natural and engineered solid stone surfaces and laminate countertops



EP21-03618

EP21 SNEEZE GUARDS

Item Number	Number of Bays	Width Center of Post to center of Post	Depth Center of Post to center of Post	Height	Ship Weight [■]	List Price
12" End Panels ◊						
EP21-03612	1	36"	11 1/2"	17 1/4"	34 lbs.	\$2130
EP21-04812	2	48"	11 1/2"	17 1/4"	45 lbs.	3108
EP21-06012	2	60"	11 1/2"	17 1/4"	52 lbs.	3300
EP21-07212	2	72"	11 1/2"	17 1/4"	58 lbs.	3496
EP21-08412	2	84"	11 1/2"	17 1/4"	64 lbs.	3684
EP21-09612	3	96"	11 1/2"	17 1/4"	82 lbs.	4862
EP21-10812	3	108"	11 1/2"	17 1/4"	82 lbs.	4862
EP21-12012	3	120"	11 1/2"	17 1/4"	92 lbs.	5144
EP21-13212	4	132"	11 1/2"	17 1/4"	106 lbs.	6228
EP21-14412	4	144"	11 1/2"	17 1/4"	107 lbs.	6228
15" End Panels ◊						
EP21-03615	1	36"	15"	17 1/4"	36 lbs.	\$2358
EP21-04815	2	48"	15"	17 1/4"	47 lbs.	3336
EP21-06015	2	60"	15"	17 1/4"	54 lbs.	3528
EP21-07215	2	72"	15"	17 1/4"	60 lbs.	3724
EP21-08415	2	84"	15"	17 1/4"	66 lbs.	3912
EP21-09615	3	96"	15"	17 1/4"	84 lbs.	5090
EP21-10815	3	108"	15"	17 1/4"	84 lbs.	5090
EP21-12015	3	120"	15"	17 1/4"	94 lbs.	5372
EP21-13215	4	132"	15"	17 1/4"	108 lbs.	6456
EP21-14415	4	144"	15"	17 1/4"	108 lbs.	6456
18" End Panels						
EP21-03618	1	36"	18"	17 1/4"	38 lbs.	\$2358
EP21-04818	2	48"	18"	17 1/4"	49 lbs.	3336
EP21-06018	2	60"	18"	17 1/4"	56 lbs.	3528
EP21-07218	2	72"	18"	17 1/4"	62 lbs.	3724
EP21-08418	2	84"	18"	17 1/4"	68 lbs.	3912
EP21-09618	3	96"	18"	17 1/4"	86 lbs.	5090
EP21-10818	3	108"	18"	17 1/4"	86 lbs.	5090
EP21-12018	3	120"	18"	17 1/4"	96 lbs.	5372
EP21-13218	4	132"	18"	17 1/4"	110 lbs.	6456
EP21-14418	4	144"	18"	17 1/4"	110 lbs.	6456

Customizable features

- Face Panel: Available in 8" to 42" per Bay in 1/4" increments
- End Panel: Right only, left only or none
- Flange: Above or Below counter compression available
- Glass Corners: Square (Radius standard)
- Light Bar: Panel must be 18" Wide or Wider
- Post Finish: Powder coated black color
- Adjustable Brackets (for radius corner glass only)



Customize now!

Custom configurations available: Hardware, glass, lighting and more! Scan the QR code on left.

www.hatcosneezeguards.com

◊ Side panels may not meet NSF standards, see NSF guidelines for clarification.

■ Items may be shipped in multiple boxes.



**Model EP7
Flav-R-Shield™
Full-Service, Pass-Over
Sneeze Guards**

Enhance and protect food products simultaneously with Hatco's Flav-R-Shield™ Sneeze Guards – EP7 for barrier applications. These stylish yet functional Sneeze Guards, with several patented features, are ideal for point of sale. They help to form a protective shield.

- Easily installed on a food counter or reception desk
- Stylish Diameter SAE 304 brushed stainless steel Posts
- Durable tempered glass construction with square corners and flat polished edges for a clean look throughout
- 42" High, 1/4" Thick glass Face Panel
- Unit mounts to face of cabinet, Face Height is adjustable up and down
- Mounts to stainless steel, natural and engineered solid stone surfaces and laminate countertops
- Posts allows for side counter installation and adjustment of post Height after the install - Flange holds to post outside the counter

Customizable features

- Additional Widths available



EP7-24



Customize now!

Custom configurations available: Hardware, glass, lighting and more! Scan the QR code on left.

www.hatcosneezeguards.com

EP7 SNEEZE GUARDS

Item Number	Number of Bays	Width Center of post to center of post	Depth	Height	Approx. Ship. Weight [■]	List Price
EP7-24	1	24"	1 3/4"	42" (Face Panel Height is adjustable up and down)	33 lbs.	\$1036
EP7-36	1	36"	1 3/4"	42" (Face Panel Height is adjustable up and down)	44 lbs.	1222
EP7-48	1	48"	1 3/4"	42" (Face Panel Height is adjustable up and down)	58 lbs.	1350

■ Items may be shipped in multiple boxes.



Model B950 Flav-R-Shield™ Self-Serve, Adjustable Sneeze Guards

Enhance and protect food products simultaneously with Hatco's Flav-R-Shield™ Adjustable Self-Serve Sneeze Guards – B950 for self-service applications. These stylish yet functional Sneeze Guards, with several patented features, are ideal for buffet lines and serving stations to safeguard your food.

- Patented 15° increment rotating Face Panel with clearances of 9-19" when glass is at a 45° angle
- Unit comes in one to four bay models, depending on Width
- 1" SAE 304 brushed stainless steel Posts have 1½" Base Tubes
- Mounting Post Height is adjustable up to 23" – based on pivoting Face and adjustable Post Bracket

- Durable 3/8" thick tempered glass construction with 3/4" radius corners and flat polished edges for a clean look – stand alone End Panels are 1/4" Thick x 18" Deep x 19" High
- Stainless steel finish Flange Cup Base is 2" in Dia.
- Mounts to stainless steel, natural and engineered solid stone surfaces and laminate countertops



B950-36

Customizable features

- Face Panel Width: 8" to 75" in 1/4" increments
- End Panel: Right only, left only or none
- End Panel Glass Depth: 8" to 75" in 1/4" increments
- Light Bar: Panel must be 18" Wide or Wider
- Light Bracket (stand alone): 1, 2, 3, or 4 light brackets
- Post Finish: Powder coated black



Customize now!
Custom configurations available: Hardware, glass, lighting and more! Scan the QR code on left.

www.hatcosneezeguards.com

B950 SNEEZE GUARDS

Item Number	Number of Bays	Width Center of Post to center of Post	Depth Center of Post to edge of End Panel	Height	Ship Weight [■]	List Price
B950-36	1	36"	18"	Up to 23"	66 lbs.	\$3056
B950-48	2	48"	18"	Up to 23"	86 lbs.	4184
B950-60	2	60"	18"	Up to 23"	92 lbs.	4384
B950-72	2	72"	18"	Up to 23"	100 lbs.	4584
B950-84	2	84"	18"	Up to 23"	106 lbs.	4796
B950-96	3	96"	18"	Up to 23"	134 lbs.	6112
B950-108	3	108"	18"	Up to 23"	134 lbs.	6112
B950-120	3	120"	18"	Up to 23"	143 lbs.	6430
B950-132	4	132"	18"	Up to 23"	167 lbs.	7640
B950-144	4	144"	18"	Up to 23"	184 lbs.	7640

↳ To attach, use single 3/8" single lag bolt in center or three (#10 or #12) drywall screws– not included.
■ Items may be shipped in boxes.



**Model B950SWIVEL
Flav-R-Shield™
Self-Service
Sneeze Guards**

Enhance and protect food products simultaneously with Hatco's Flav-R-Shield™ Adjustable Self-Serve Sneeze Guards – B950SWIVEL for self-service applications. These stylish yet functional Sneeze Guards, with several patented features, are ideal for buffet lines and serving stations to safeguard your food.

- Bracket Heads on Face swivel 90° up to 270° to accommodate turns when using multiple bays
- Patented 15° increment rotating Face Panel with clearances of 9"-19" when glass is at a 45° angle
- Mounting Post Height is adjustable up to 23" – based on pivoting Face and adjustable Post Bracket
- Unit comes in one to four bay models, depending on Width

- 1" SAE 304 brushed stainless steel Posts have 1½" Base Tubes
- Durable ¾" thick tempered glass construction with ¾" radius corners and flat polished edges for a clean look – stand alone End Panels are ¼" Thick x 12" Deep x 20" High
- Stainless steel finish Flange Cup Base is 2" in Diameter
- Mounts to stainless steel, natural and engineered solid stone surfaces and laminate countertops



B950SWIVEL-36

Customizable features

- Face Panel Width: 8" to 75" in ¼" increments
- End Panel: Right only, left only or none
- End Panel: Available in Depths of 8" to 75" in ¼" increments
- Light Bar: Panel must be 18" Wide or Wider
- Light Bracket (stand alone): 1, 2, 3, or 4 light brackets
- Post Finish: Powder coated black



Customize now!
Custom configurations available: Hardware, glass, lighting and more! Scan the QR code on left.

www.hatcosneezeguards.com

B950SWIVEL SNEEZE GUARDS

Item Number	Number of Bays	Width Center of Post to center of Post	Depth Center of Post to edge of End Panel	Height Based on pivoting Face and Adjustable Bracket	Side Panel Depth x Height	Ship Weight [■]	List Price
B950SWIVEL-36	1	36"	18"	Up to 23"	18" x 19"	66 lbs.	\$3220
B950SWIVEL-48	2	48"	18"	Up to 23"	18" x 19"	86 lbs.	4510
B950SWIVEL-60	2	60"	18"	Up to 23"	18" x 19"	92 lbs.	4710
B950SWIVEL-72	2	72"	18"	Up to 23"	18" x 19"	98 lbs.	4910
B950SWIVEL-84	2	84"	18"	Up to 23"	18" x 19"	106 lbs.	5122
B950SWIVEL-96	3	96"	18"	Up to 23"	18" x 19"	134 lbs.	6600
B950SWIVEL-108	3	108"	18"	Up to 23"	18" x 19"	134 lbs.	6600
B950SWIVEL-120	3	120"	18"	Up to 23"	18" x 19"	143 lbs.	6918
B950SWIVEL-132	4	132"	18"	Up to 23"	18" x 19"	163 lbs.	8290
B950SWIVEL-144	4	144"	18"	Up to 23"	18" x 19"	167 lbs.	8290

✦ To attach, use single ¾" single lag bolt in center or three (#10 or #12) drywall screws– not included.

■ Items may be shipped in boxes.



Model EP15 Flav-R-Shield™ Self-Service, Pass-Over Sneeze Guards

Enhance and protect food products simultaneously with Hatco's Flav-R-Shield™ Sneeze Guards – EP15 for stationary full-service applications. These stylish yet functional Sneeze Guards, with several patented features, are ideal for buffet lines and serving stations. They provide all the requirements to safeguard your foods.

- Stylish Posts are 1" Diameter SAE 304 brushed stainless steel - front Posts are tilted back to an 80° angle
- 2" Diameter stainless steel finish Flanges with unique tight-fitting Flange Covers that hide mounting screws and maximize cleanability

- Durable 1/4" Thick tempered glass construction with 3/4" radius corners and flat polished edges for a clean look
- Unit is 22" High and offers two 18" Deep End Panels
- Mounts to stainless steel, natural and engineered solid stone surfaces and laminate countertops

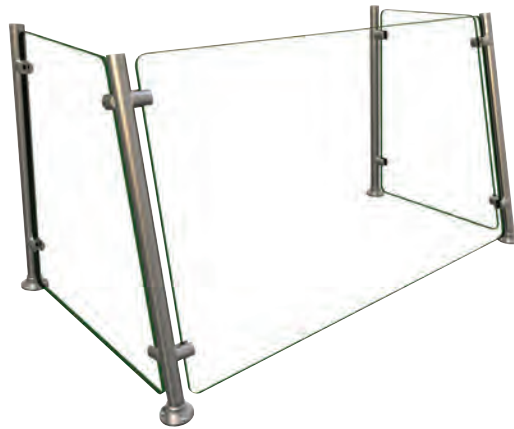

EP15-36

Customizable features

- Post Height: 8" to 30" in 1/4" increments
- Face Panel: Available in 8" to 42" per Bay in 1/4" increments
- End Panel: Right only, left only or none
- Flange: Above or Below counter compression available
- Glass Corners: Square (Radius standard)
- Light Bar: Panel must be 18" Wide or Wider
- Post Finish: Powder coated black color
- Adjustable Brackets (for radius corner glass only)



Customize now!
Custom configurations available: Hardware, glass, lighting and more! Scan the QR code on left.

www.hatcosneezeguards.com

EP15 SNEEZE GUARDS

Item Number ◊	Number of Bays	Width Center of Post to center of Post	Depth Center of Post to center of Post	Height	Ship Weight [■]	List Price
EP15-36	1	36"	18"	22"	72 lbs.	\$2806
EP15-48	2	48"	18"	22"	88 lbs.	3414
EP15-60	2	60"	18"	22"	95 lbs.	3554
EP15-72	2	72"	18"	22"	102 lbs.	3690
EP15-84	2	84"	18"	22"	106 lbs.	3834
EP15-96	3	96"	18"	22"	130 lbs.	4574
EP15-108	3	108"	18"	22"	130 lbs.	4574
EP15-120	3	120"	18"	22"	136 lbs.	4790
EP15-132	4	132"	18"	22"	158 lbs.	5458
EP15-144	4	144"	18"	22"	159 lbs.	5458

◊ 2" long #8 counter sink screws are recommended for installations on most surfaces. Requirements will vary based on surface material and thickness. Fasteners not included.
 ■ Items may be shipped in multiple boxes.



**Model ES29
Flav-R-Shield™
Self-Service
Sneeze Guards**

Enhance and protect food products simultaneously with Hatco's Flav-R-Shield™ Sneeze Guards – ES29 for stationary self-service applications. These stylish yet functional Sneeze Guards, with several patented features, are ideal for buffet lines and serving stations. They provide all the requirements to safeguard your foods.

- Unit is self-service, designed for 40" deep counter tops
- Stylish 1" Diameter SAE 304 brushed stainless steel Posts
- 2" Diameter stainless steel finish Flanges with unique tight-fitting Flange Covers that hide mounting screws and maximize cleanability
- Unit is 22" High

- Durable 3/8" Thick tempered glass construction Face Panel, 1/4" Thick with End Panels, both with 0.75" radius corners and flat polished edges for a clean look
- Glass components consist of a Face Panel, two 18" Deep End Panels and a 5 1/2" Deep Top Shelf
- Mounts to stainless steel, natural and engineered solid stone surfaces and laminate countertop



ES29-36

Customizable features

- Available for various countertop Widths 24" to 54"
- Face Panel: Available in 8" to 42" per Bay in 1/4" increments
- End Panel: Right only, left only or none
- Glass Corners: Square (Radius standard)
- Flange options: Above or below counter compression
- Light Bar: Glass must be 18" Wide or Wider
- Post Finish: Powder coated black color
- Adjustable Brackets (for radius corner glass only)



Customize now!
Custom configurations available: Hardware, glass, lighting and more! Scan the QR code on left.

www.hatcosneezeguards.com

ES29 SNEEZE GUARDS

Item Number ◊	Number of Bays	Width Center of Post to center of Post	Depth Center of Post to center of Post	Height	Ship Weight [■]	List Price
ES29-36	1	36"	18"	22"	194 lbs.	\$ 4748
ES29-48	2	48"	18"	22"	238 lbs.	5452
ES29-60	2	60"	18"	22"	263 lbs.	6894
ES29-72	2	72"	18"	22"	290 lbs.	7522
ES29-84	2	84"	18"	22"	318 lbs.	8158
ES29-96	3	96"	18"	22"	385 lbs.	8930
ES29-108	3	108"	18"	22"	385 lbs.	9414
ES29-120	3	120"	18"	22"	428 lbs.	11250
ES29-132	4	132"	18"	22"	480 lbs.	12408
ES29-144	4	144"	18"	22"	480 lbs.	12408

◊ 2" long #8 counter sink screws are recommended for installations on most surfaces. Requirements will vary based on surface material and thickness. Fasteners not included.

■ Items may be shipped in multiple boxes.



Model ES40 Flav-R-Shield™ Self-Service Sneeze Guards

Enhance and protect food products simultaneously with Hatco's Flav-R-Shield™ Sneeze Guards – ES40 for stationary self-service applications. These stylish yet functional Sneeze Guards, with several patented features, are ideal for buffet lines and serving stations and perfect for countertops with tray slides. They provide all the requirements to safeguard your foods.

- Stylish 1" Diameter SAE 304 brushed stainless steel Posts
- 2" Diameter stainless steel finish Flanges with unique tight-fitting Flange Covers that hide mounting screws and maximize cleanability
- Durable 1/4" thick tempered glass construction with 3/4" radius corners and flat polished edges for a clean look throughout

- Glass components consist of a Face Panel, set of two glass End Panels and a 11 1/2" Deep Top Shelf
- Mounts to stainless steel, natural and engineered solid stone surfaces and laminate countertops

Customizable features

- Face Panel: Available in 8" to 42" per Bay in 1/4" increments
- Square corner glass (radius standard)
- End Panel: Right only, left only or none
- Flange: Above or below counter compression
- Glass Corners: Square (Radius standard)
- Post Finish: Powder coated black color
- Adjustable Brackets (for radius corner glass only)



ES40-48



Customize now!

Custom configurations available: Hardware, glass, lighting and more! Scan the QR code on left.

www.hatcosneezeguards.com

ES40 SNEEZE GUARDS

Item Number	Number of Bays	Width Far left center of Post on Bay 1 to far right center of Post on Bay 1	Depth End of Face to edge of End Panel	Height	Approx. Ship Weight	List Price
ES40-48	2	48"	20"	23 3/4"	81 lbs.	\$3916
ES40-60	2	60"	20"	23 3/4"	88 lbs.	4120
ES40-72	2	72"	20"	23 3/4"	95 lbs.	4336
ES40-84	2	84"	20"	23 3/4"	101 lbs.	4560

◇ 2" long #8 counter sink screws are recommended for installations on most surfaces. Requirements will vary based on surface material and thickness. Fasteners not included.

■ Items may be shipped in multiple boxes.



**Model ES53
Flav-R-Shield™
Self-Service, Stationary
Double-Sided
Sneeze Guards**

Enhance and protect food products simultaneously with Hatco's Flav-R-Shield™ Sneeze Guards – ES53 for stationary double-sided self-service applications. These stylish yet functional Sneeze Guards, with several patented features, are ideal for buffet lines and serving stations. They provide all the requirements to safeguard your foods.

- Stylish 1" Diameter SAE 304 brushed stainless steel Posts
- 2" Diameter stainless steel finish Flanges with unique tight-fitting Flange Covers that hide mounting screws and maximize cleanability
- Durable 3/8" Thick tempered glass construction with 3/4" radius corners and flat polished edges for a clean look throughout

- Unit consists of Top Panel and two double-sided End Panels
11⁵/₁₆" High x 20" Deep total
- Height is adjustable up to 54"
- Mounts to stainless steel, natural and engineered solid stone surfaces and laminate countertops



ES53-36

Customizable features

- Face Panel: 8" to 42" in 1/4" increments
- End Panel: Right only, left only or none
- Flange options: Above or below counter compression
- Glass Corners: Square (Radius standard)
- Light Bar: Panel must be 18" Wide or Wider
- Post Finish: Powder coated black
- Adjustable Brackets (for radius corner glass only)



Customize now!
Custom configurations available: Hardware, glass, lighting and more! Scan the QR code on left.

www.hatcosneezeguards.com

ES53 SNEEZE GUARDS

Item Number ◊	Number of Bays	Width Center of post to center of post	Depth Edge of glass to edge of glass	Height	Approx. Ship. Weight ■	List Price
ES53-36	1	36"	20"	Adjustable up to 54"	62 lbs.	\$2278
ES53-48	2	48"	20"	Adjustable up to 54"	82 lbs.	2616
ES53-60	2	60"	20"	Adjustable up to 54"	90 lbs.	3154
ES53-72	2	72"	20"	Adjustable up to 54"	98 lbs.	3282
ES53-84	2	84"	20"	Adjustable up to 54"	106 lbs.	3406
ES53-96	3	96"	20"	Adjustable up to 54"	134 lbs.	3958
ES53-108	3	108"	20"	Adjustable up to 54"	134 lbs.	4158
ES53-120	3	120"	20"	Adjustable up to 54"	146 lbs.	4472
ES53-132	4	132"	20"	Adjustable up to 54"	169 lbs.	5300
ES53-144	4	144"	20"	Adjustable up to 54"	169 lbs.	5300

◊ 2" long #8 counter sink screws are recommended for installations on most surfaces. Requirements will vary based on surface material and thickness. Fasteners not included.
■ Items may be shipped in multiple boxes.



Model ES73 Flav-R-Shield™ Self-Service Sneeze Guards

Enhance and protect food products simultaneously with Hatco's Flav-R-Shield™ Sneeze Guards – ES73 for stationary self-service applications. These stylish yet functional Sneeze Guards, with several patented features, are ideal for buffet lines and serving stations and perfect for countertops with tray slides. They provide all the requirements to safeguard your foods.

- Stylish 1" Diameter SAE 304 brushed stainless steel Posts
- Height is 23³/₄"
- 2" Diameter stainless steel finish Flanges with unique tight-fitting Flange Covers that hide mounting screws and maximize cleanability
- Durable 1/4" thick tempered glass construction with 3/4" radius corners and flat polished edges for a clean look

- Units consist of two Glass Face Panels, two Top Shelves and two glass End Panels
- 18" Deep End Panels required to meet NSF standards
- Mounts to stainless steel, natural and engineered solid stone surfaces and laminate countertops



ES73-48

Customizable features

- Face Panel: 8" to 42" in 1/4" increments
- End Panel: Right only, left only or none
- End Panel Support Posts: Brushed Stainless, Black
- Flange options: Above or below counter compression
- Square corner glass (Radius standard)
- Light Bar: Panel must be 18" Wide or Wider
- Posts: Powder coated black color
- Adjustable Brackets (for radius corner glass only)



Customize now!
Custom configurations available: Hardware, glass, lighting and more! Scan the QR code on left.

www.hatcosneezeguards.com

ES73 SNEEZE GUARDS

Item Number ◊	Number of Bays	Width		Depth		Height	Approx. Ship. Weight ■	List Price
		Far left center of Post on Bay 1 to far right center of Post on Bay 2		Front of Post bend to back edge of Face panel				
ES73-48	2	48"		18 1/2"		23 3/4"	46 lbs.	\$4034
ES73-60	2	60"		18 1/2"		23 3/4"	53 lbs.	4236
ES73-72	2	72"		18 1/2"		23 3/4"	59 lbs.	4452
ES73-84	2	84"		18 1/2"		23 3/4"	66 lbs.	4678

◊ 2" long #8 counter sink screws are recommended for installations on most surfaces. Requirements will vary based on surface material and thickness. Fasteners not included.

■ Items may be shipped in multiple boxes.



**Model ES82
Flav-R-Shield™
Self-Service, Double-
Sided Sneeze Guard**

Enhance and protect food products simultaneously with Hatco's Flav-R-Shield™ Sneeze Guards – ES82 for stationary double-sided self-service applications. These stylish yet functional Sneeze Guards, with several patented features, are ideal for buffet lines and serving stations. They provide all the requirements to safeguard your foods.

- Unit is double-sided, self-service designed for 40" Deep counter tops and is 23" High
- Stylish 1" Diameter SAE 304 brushed stainless steel Posts
- 2" Diameter stainless steel finish Flanges with unique tight-fitting Flange Covers that hide mounting screws and maximize cleanability

- Durable 3/8" Thick tempered glass construction with 3/4" radius corners and flat polished edges for a clean look throughout
- Comes with Two 11 1/2" Deep Face Panels, 21 16/25" Deep Top Shelf and two glass End Panels which are 23" High x 38" Deep
- Mounts to stainless steel, natural and engineered solid stone surfaces and laminate countertops



ES82-36

Customizable features

- Countertop: Unit available for 24" to 54" Wide countertops
- Face Panel: Available in 8" to 42" per Bay in 1/4" increments
- End Panel: Right only, left only or none
- Flanges: Above or Below counter compression available
- Glass Corners: Square (Radius standard)
- Light Bar: Panel must be 18" Wide or Wider
- Post Finish: Powder coated black color
- Adjustable Brackets (for radius corner glass only)



Customize now!
Custom configurations available: Hardware, glass, lighting and more! Scan the QR code on left.

www.hatcosneezeguards.com

ES82 SNEEZE GUARDS

Item Number ◊	Number of Bays	Width Center of post to center of post	Depth Center of post to center of post	Height	Approx. Ship. Weight ■	List Price
ES82-36	1	36"	38"	23"	226 lbs.	\$5714
ES82-48	2	48"	38"	23"	275 lbs.	6594
ES82-60	2	60"	38"	23"	310 lbs.	8346
ES82-72	2	72"	38"	23"	352 lbs.	9290
ES82-84	2	84"	38"	23"	399 lbs.	10242
ES82-96	3	96"	38"	23"	451 lbs.	11050
ES82-108	3	108"	38"	23"	479 lbs.	12126
ES82-120	3	120"	38"	23"	550 lbs.	14294
ES82-132	4	132"	38"	23"	605 lbs.	15506
ES82-144	4	144"	38"	23"	605 lbs.	15506

◊ 2" long #8 counter sink screws are recommended for installations on most surfaces. Requirements will vary based on surface material and thickness. Fasteners not included.

■ Items may be shipped in multiple boxes.



Model ES31 Flav-R-Shield™ Self-Service Sneeze Guards

Enhance and protect food products simultaneously with Hatco's Flav-R-Shield™ Sneeze Guards - ES31 for stationary self-service applications. These stylish yet functional Sneeze Guards, with several patented features, are ideal for buffet lines and serving stations. They provide all the requirements to safeguard your foods.

- Stylish 1" Diameter SAE 304 brushed stainless steel Posts
- 2" Diameter stainless steel finish Flanges with unique tight-fitting Flange Covers that hide mounting screws and maximize cleanability
- Durable 1/4" Thick tempered glass construction with 3/4" radius corners and flat polished edges for a clean look throughout
- Comes with Glass Face Panel and two 18" Deep glass End Panels to meet NSF standards
- Mounts to stainless steel, natural and engineered solid stone surfaces and laminate countertops



ES31-36



ES31-48

ES31-96

ES31-132

ES31 SNEEZE GUARDS

Item Number ◊	Number of Bays	Width Center of Post to center of Post	Depth Center of Post to end of glass ‡	Height	Ship Weight■	List Price
ES31-36	1	36"	18"	22 1/8"	33 lbs.	\$1987
ES31-48	2	48"	18"	22 1/8"	41 lbs.	2642
ES31-60	2	60"	18"	22 1/8"	50 lbs.	2743
ES31-72	2	72"	18"	22 1/8"	57 lbs.	2854
ES31-84	2	84"	18"	22 1/8"	63 lbs.	2969
ES31-96	3	96"	18"	22 1/8"	80 lbs.	3720
ES31-108	3	108"	18"	22 1/8"	86 lbs.	3720
ES31-120	3	120"	18"	22 1/8"	90 lbs.	3893
ES31-132	4	132"	18"	22 1/8"	103 lbs.	4586
ES31-144	4	144"	18"	22 1/8"	117 lbs.	4586

- ◊ 2" long #8 counter sink screws are recommended for installations on most surfaces. Requirements will vary based on surface material and thickness. Fasteners not included.
- ‡ Side Panels include back support legs.
- Items may be shipped in multiple boxes.



Customize unit now!

Custom configurations available:
Hardware, glass, lighting and more!
Scan or click the QR code to the left.
www.hatcosneezeguards.com



ES67 Flav-R-Shield™ Self-Service Sneeze Guards

Enhance and protect food products simultaneously with Hatco's Flav-R-Shield™ Sneeze Guards - ES67 for stationary self-service applications. These stylish yet functional Sneeze Guards, with several patented features, are ideal for buffet lines and serving stations and perfect for countertops with tray slides. They provide all the requirements to safeguard your foods.

- Stylish 1" Diameter SAE 304 brushed stainless steel Posts
- 2" Diameter stainless steel finish Flanges with unique tight-fitting Flange Covers that hide mounting screws and maximize cleanability
- Durable 1/4" Thick tempered glass or construction with 3/4" radius corners and flat polished edges for a clean look throughout
- Glass Face Panels and two 18" Deep glass End Panels
- Mounts to stainless steel, natural and engineered solid stone surfaces and laminate countertops



ES67-48



ES67-60



ES67-72



ES67-84

ES67 SNEEZE GUARDS

Item Number	Number of Bays	Width		Depth		Height	Ship Weight	List Price
		Far left center of Post on Bay 1 to far right center of Post on Bay 2	Individual bay, inside Flange to inside Flange	Front of Face Panel to back of End Panel				
ES67-48	2	48"	22"	19 13/16"	22 1/8"	41 lbs.	\$2563	
ES67-60	2	60"	28"	19 13/16"	22 1/8"	50 lbs.	2542	
ES67-72	2	72"	34"	19 13/16"	22 1/8"	57 lbs.	2652	
ES67-84	2	84"	40"	19 13/16"	22 1/8"	63 lbs.	2767	

◇ 2" long #8 counter sink screws are recommended for installations on most surfaces. Requirements will vary based on surface material and thickness. Fasteners not included.
 ■ Items may be shipped in multiple boxes.



Customize unit now!

Custom configurations available:
 Hardware, glass, lighting and more!
 Scan or click the QR code to the left.
www.hatcosneezeguards.com



ES90 Flav-R-Shield™ Self-Service Sneeze Guards

Enhance and protect food products simultaneously with Hatco's Flav-R-Shield™ Sneeze Guards - ES90 for stationary single-sided self-service applications. These stylish yet functional Sneeze Guards, with several patented features, are ideal for buffet lines and serving stations. They provide all the requirements to safeguard your foods.

- Stylish 1" Diameter SAE 304 brushed stainless steel Posts
- 2" Diameter stainless steel finish Flanges with unique tight-fitting Flange Covers that hide mounting screws and maximize cleanability
- Durable 3/8" Thick tempered glass construction with 3/4" radius corners and flat polished edges for a clean look throughout
- Adjustable glass Face Panels, glass Top Shelf and two End Panels
- 19 3/8" High x 24 3/16" Deep
- Mounts to stainless steel, natural and engineered solid stone surfaces and laminate countertops



ES90-36

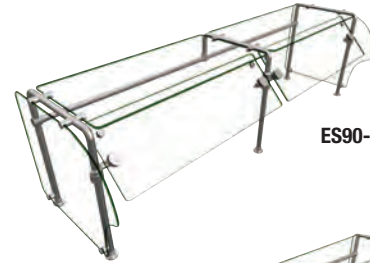

ES90-72



ES90-108



ES90-144

ES90 SNEEZE GUARDS

Item Number ◊	Number of Bays	Width Center of Post to center of Post	Depth Center of Post to center of Post	Depth End Panel glass	Height	Ship Weight [■]	List Price
ES90-36	1	36"	16 1/4"	24 3/16"	22 5/8"	183 lbs.	\$ 4500
ES90-48	1	48"	16 1/4"	24 3/16"	22 5/8"	209 lbs.	4794
ES90-60	2	60"	16 1/4"	24 3/16"	22 5/8"	243 lbs.	7366
ES90-72	2	72"	16 1/4"	24 3/16"	22 5/8"	266 lbs.	7198
ES90-84	2	84"	16 1/4"	24 3/16"	22 5/8"	291 lbs.	8630
ES90-96	2	96"	16 1/4"	24 3/16"	22 5/8"	319 lbs.	7786
ES90-108	2	108"	16 1/4"	24 3/16"	22 5/8"	349 lbs.	9886
ES90-120	3	120"	16 1/4"	24 3/16"	22 5/8"	387 lbs.	12044
ES90-132	3	132"	16 1/4"	24 3/16"	22 5/8"	429 lbs.	10778
ES90-144	3	144"	16 1/4"	24 3/16"	22 5/8"	470 lbs.	10778

◊ 2" long #8 counter sink screws are recommended for installations on most surfaces. Requirements will vary based on surface material and thickness. Fasteners not included.

■ Items may be shipped in multiple boxes.



Customize unit now!

Custom configurations available:
Hardware, glass, lighting and more!
Scan or click the QR code to the left.
www.hatcosneezeguards.com



ES92 Flav-R-Shield™ Self-Service, Double-Sided Sneeze Guards

Enhance and protect food products simultaneously with Hatco's Flav-R-Shield™ Sneeze Guards - ES92 for stationary double-sided self-service applications. These stylish yet functional Sneeze Guards, with several patented features, are ideal for buffet lines and serving stations. They provide all the requirements to safeguard your foods. They provide all the requirements to safeguard your foods.

- Unit is Double-sided Self-service designed for 40" Deep counter tops
- Stylish 1" Diameter SAE 304 brushed stainless steel Posts
- 2" Diameter stainless steel finish Flanges with unique tight-fitting Flange Covers that hide mounting screws and maximize cleanability
- Durable 3/8" Thick tempered glass construction with 3/4" radius corners and flat polished edges for a clean look throughout
- Two adjustable Face Panels, glass Top Shelf and two glass End Panels which are 20 1/4" High x 37 3/4" Deep
- Mounts to stainless steel, natural and engineered solid stone surfaces and laminate countertops



ES92-36



ES92-60



ES92-120

ES92 SNEEZE GUARDS

Item Number ◊	Number of Bays	Width Center of Post to center of Post	Depth Center of Post to center of Post	Depth End Panel glass	Height	Ship Weight■	List Price
ES92-36	1	36"	26 1/4"	37 3/4"	22 5/8"	226 lbs.	\$ 6578
ES92-48	1	48"	26 1/4"	37 3/4"	22 5/8"	275 lbs.	7458
ES92-60	2	60"	26 1/4"	37 3/4"	22 5/8"	310 lbs.	10238
ES92-72	2	72"	26 1/4"	37 3/4"	22 5/8"	353 lbs.	11182
ES92-84	2	84"	26 1/4"	37 3/4"	22 5/8"	400 lbs.	12134
ES92-96	2	96"	26 1/4"	37 3/4"	22 5/8"	451 lbs.	12942
ES92-108	2	108"	26 1/4"	37 3/4"	22 5/8"	507 lbs.	14018
ES92-120	3	120"	26 1/4"	37 3/4"	22 5/8"	550 lbs.	17214
ES92-132	3	132"	26 1/4"	37 3/4"	22 5/8"	627 lbs.	18426
ES92-144	3	144"	26 1/4"	37 3/4"	22 5/8"	705 lbs.	18426

◊ 2" long #8 counter sink screws are recommended for installations on most surfaces. Requirements will vary based on surface material and thickness. Fasteners not included.

■ Items may be shipped in multiple boxes.



Customize unit now!

Custom configurations available:
Hardware, glass, lighting and more!
Scan or click the QR code to the left.
www.hatcosneezeguards.com



Model ALLIN1 Flav-R-Shield™ Portable, Adjustable Sneeze Guards

Enhance and protect food products simultaneously with Hatco's Flav-R-Shield™ Sneeze Guards - ALLIN1 for flexible and portable self-service applications. These stylish yet functional Sneeze Guards, with several patented features, are ideal for buffet lines, serving stations and especially for events. They safeguard your food and collapse flat for easy storage.

- Unit is a single bay, super adjustable, collapsible, flat stack, portable model
- Patented, durable and collapsible 1/4" Thick acrylic Face Panel with polished edges, 3/4" radius corners and is 14" Deep
- Patented, adjustable push-button hinges with 15° incremental locking, allow the acrylic Face Panel to meet almost any configuration
- Three attached, pivoting 1/2" Thick 10" High machined brushed aluminum Leg segments

ALLIN1-24



ALLIN1-72



ALLIN1-60



ALLIN1-48

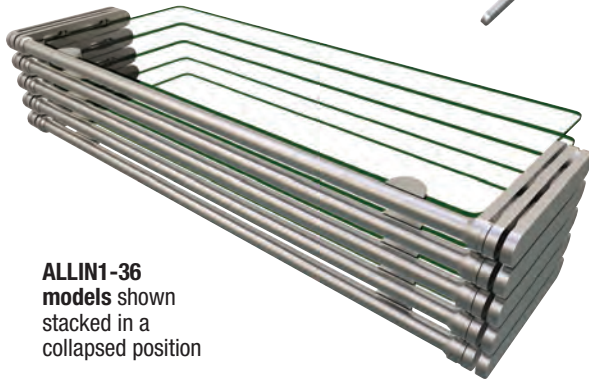
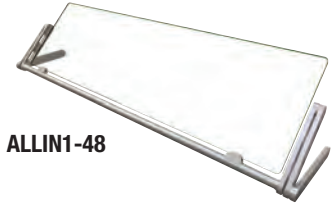

ALLIN1-36 models shown stacked in a collapsed position



Customize now!
Custom configurations available: Hardware, glass, lighting and more! Scan the QR code on left.

www.hatcosneezeguards.com

ALLIN1 SNEEZE GUARDS

Item Number	Number of Bays	Width Inside Leg to inside Leg	Depth of Foot	Height	Approx. Ship Weight*	List Price
ALLIN1-24	1	26 1/2"	10" to approx. 15 1/4"	Adjustable to approx. 30"	13 lbs.	\$1700
ALLIN1-36	1	38 1/2"	10" to approx. 15 1/4"	Adjustable to approx. 30"	19 lbs.	1900
ALLIN1-48	1	50 1/2"	10" to approx. 15 1/4"	Adjustable to approx. 30"	25 lbs.	2108
ALLIN1-60	1	62 1/2"	10" to approx. 15 1/4"	Adjustable to approx. 30"	50 lbs.	2304
ALLIN1-72	1	74 1/2"	10" to approx. 15 1/4"	Adjustable to approx. 30"	60 lbs.	2500

* Items may be shipped in multiple boxes.



**Model EP6
Flav-R-Shield™
Portable Sneeze Guards**

Enhance and protect food products simultaneously with Hatco's Flav-R-Shield™ Sneeze Guards – EP6 for portable Pass-over applications. These stylish yet functional Sneeze Guards, with several patented features, are ideal for buffet lines and serving stations to safeguard your food.

- Stainless steel finish fixed Base feet are 1 1/2" Wide x 14" Deep each
- Mounting Post Height is 27 1/2"
- Stylish 1" Diameter SAE 304 brushed stainless steel Posts

- Durable 1/4" Thick tempered glass construction with square corners and flat polished edges for a clean look throughout
- Glass components consist of a Face Panel and two 18" Deep End Panels



EP6-36

Customizable features

- Face Panel Width- 8" to 54" in 1/4" increments
- 3/4" radius cornered Panels
- End Panel: Right only, left only or none
- End Panel Length - 8" to 54" in 1/4" increments
- Panel Height - 6" or 12" Higher



Customize now!

Custom configurations available: Hardware, glass, lighting and more! Scan the QR code on left.

www.hatcosneezeguards.com

EP6 SNEEZE GUARDS

Item Number	Number of Bays	Width Center of Post to center of Post	Depth Center of Post to center of Post	Height	Approx. Ship Weight [■]	List Price
EP6-36	1	36"	18"	27 1/2"	104 lbs.	\$2084
EP6-48	2	48"	18"	27 1/2"	126 lbs.	2588
EP6-60	2	60"	18"	27 1/2"	133 lbs.	2724
EP6-72	2	72"	18"	27 1/2"	140 lbs.	2860
EP6-84	2	84"	18"	27 1/2"	157 lbs.	2996
EP6-96	3	96"	18"	27 1/2"	176 lbs.	3636
EP6-108	3	108"	18"	27 1/2"	176 lbs.	3636
EP6-120	3	120"	18"	27 1/2"	202 lbs.	3840
EP6-132	4	132"	18"	27 1/2"	212 lbs.	4412
EP6-144	4	144"	18"	27 1/2"	212 lbs.	4412

■ Items may be shipped in multiple boxes.



Model EP950 Flav-R-Shield™ Portable, Adjustable Curved Acrylic Sneeze Guards

Enhance and protect food products simultaneously with Hatco's Flav-R-Shield™ Sneeze Guards - EP950 for portable and adjustable self-service applications. These stylish yet functional Sneeze Guards, with several patented features, are ideal for buffet lines and serving stations. The pivoting face and adjustable height offers ultimate flexibility and safeguard your food.

- Unit is a single bay, portable model
- Durable pivoting, curved, acrylic, lens Face with polished edges and 3/4" radius corners is 1/4" Thick and 13 3/16" Deep
- Pivot clearances of adjustable curved acrylic lens Face:
 - To front: 2" to 22" from counter
 - To back: 13" to 24" from counter

- 1" 304 stainless steel Posts with 1 1/2" Base Tube have adjustable Height from 13" to 24"
- Stainless steel finish mounting feet are 2" Wide x 14" Deep with retractable Stabilizer Tabs include two mounting points for Posts



EP950-36
with standard,
fully extended
Retractable Post
Stabilizers



EP950-72
with standard Post
Stabilizers extended on
outside of base only



EP950-48
with standard Post
Stabilizers extended on
outside of base only



EP950-36
with Accessory
End Panels

EP950 SNEEZE GUARDS

Item Number	Number of Bays	Width End of left fully extended Retractable Stabilizer to end of right fully extended Retractable Stabilizer	Depth of Base	Depth with pivoting Face and multiple mounting points for foot	Height Base tube adjustable height	Ship Weight*	List Price
EP950-24	1	24"	14"	10" to 14 7/8"	13" to 24"	17 lbs.	\$1008
EP950-36	1	36"	14"	10" to 14 7/8"	13" to 24"	25 lbs.	1066
EP950-48	1	48"	14"	10" to 14 7/8"	13" to 24"	33 lbs.	1124
EP950-60	1	60"	14"	10" to 14 7/8"	13" to 24"	40 lbs.	1180
EP950-72	1	72"	14"	10" to 14 7/8"	13" to 24"	57 lbs.	1268

* Items may be shipped in multiple boxes.

ACCESSORIES (available for purchase at any time)

EP950-EP	Two 18" Deep x 19" High x 1/4" Thick acrylic End Panels with hardware	\$1080
----------	---	--------



Customize unit now!

Custom configurations available:
Hardware, glass, lighting and more!
Scan or click the QR code to the left.
www.hatcosneezeeguards.com