

# *Ice-O-Matic*

**Simply** The Cleanest Ice Machines

50 Hz PRODUCT GUIDE | VOLUME 12



ice  
is  
food.

# Ice-O-Matic®

Ice. Pure and Simple™

11100 East 45th Avenue | Denver, CO 80239

866.PUREICE | [iceomatic.com](http://iceomatic.com)



## Table of Contents

About Ice-O-Matic General Information Model Number Guide Ice Form Series Guide	<b>2</b>
<b>UCG Gourmet Series™</b> Undercounters	<b>10</b>
<b>ICE Series™</b> Undercounters ICE Series Cube Ice Makers ICE Series Cube Ice Makers - Accessories	<b>12</b>
<b>Elevation™</b> Elevation Features Elevation Series Cube Ice Makers – 565 mm Modular Elevation Series Cube Ice Makers – 768 mm Modular Elevation Series Modular - Accessories Elevation Series Modular - SafeIce Sanitation System	<b>14</b>
<b>MFI Series™ Flake</b> MFI Series Flake Ice Makers – Modular MFI Series Flake Ice Makers - Accessories	<b>19</b>
<b>Pearl Ice® Series™</b> Ice/Water Dispenser	<b>20</b>
Remote Condensers & Accessories Countertop & Hotel Ice Dispensers Ice Dispenser Accessories & Kits Storage Bins & Accessories Ice Machine & Bin Configurations ICE Series Cube Ice Makers - Accessories	<b>22</b>
Pricing   Contact Us	<b>30</b>



# About us.

Located in Denver, Colorado, Ice-O-Matic is a leading global manufacturer of a wide range of commercial ice-making products including cube ice makers, Pearl Ice® ice makers, flake ice makers, storage bins, dispensers and water filters. Since 1952 we have developed new technologies and programs, such as our new Elevation Series™ of cubers which are more efficient for business and safer for the environment.

ice  
is  
food.



## Ice with a Clear Conscience

### Sustainability

Ice-O-Matic offsets the carbon footprint of its Denver factory by using recycled packaging materials. We also recycle our industrial and office waste products.

### Made in the U.S.A

A U.S.-based company with over 200 employees nationwide, Ice-O-Matic provides and creates American jobs. Ice-O-Matic is committed to producing quality products, and to the hundreds of workers who make it happen. Ice-O-Matic products are designed and assembled in America.

### ENERGY STAR®

Ice-O-Matic partners with ENERGY STAR and is dedicated to improving energy efficiency. Each ENERGY STAR certified ice maker can save businesses energy and money on their utility bills. When considering batch-type ice makers, ENERGY STAR certified systems can save, on average, about 1,200 kwh annually, or \$125/year in electricity bill costs.

## Sizing your ice maker

- Does the existing ice maker meet peak usage during the hottest time of the year?
- Where are the various ice stations in the establishment that will need ice?
- Will multiple ice stations be serviced from one or multiple ice makers?
- For future growth, consider building in at least 20 percent additional ice capacity on new installations.

## Approximate Ice Usage Per Day

### FOOD SERVICE

Restaurant	.7 kg per person
Cocktail	1.4 kg per person/seat
Quick Service	148 ml per 207 ml to 295 ml drink 236 ml per 354 ml to 472 ml drink 354 ml per 532 ml to 709 ml drink

### LODGING

Guest Ice	2.3 kg lbs per room
Restaurant	.7 kg lbs per person
Cocktail	1.4 kg per person per seat
Catering	.45 kg per person

**NOTE:** The charts above outlines the approximate required ice amount per day, depending on application usage. For a detailed calculation based on specific needs, use the interactive Machine Size Configurator at: [iceomatic.com/products/calculator/configurator#](http://iceomatic.com/products/calculator/configurator#).



# Installation Considerations



## Allow Enough Space for the Following Elements

- The ice maker, bin and water filter
- Airflow

## Utilities

- What are the voltage and amperage characteristics of the electrical outlet that will be used for this ice maker?
- Is there a floor drain within 6 feet (1.8 meters)?
- Is there a water source with water shutoff?
- Are the utilities within 6 feet (1.8 meters) of the ice-maker location?

## Remote Installation

- Is there an outdoor condenser location above the ice maker?
- Is there easy roof access and penetration?
- Maximum precharged tubing line run considerations?

## Ice Maker Warranty

Every Ice-O-Matic ice maker is backed by a warranty that provides both parts and labor coverage. To register products, view the warranty details or check your warranty status, visit the "Warranty Registration" page at: [iceomatic.com/warranty](http://iceomatic.com/warranty).

### Cube Ice Makers – CIM and ICE Series

- Three years Parts/Labor
- Five years Parts on evaporators and compressors
- Seven years Parts/Labor on evaporators with IOM filter program (*U.S.A. and Canada only*)
- Includes remote condensers

### Flake Ice Makers – MFI Series

- Three years Parts/Labor
- Five years Parts coverage on the compressor

### Pearl Ice® Ice Makers – GEM Series

- Modular – Three years Parts and Labor
- Countertop Dispenser – Two years Parts/Labor
- Modular/Dispenser – Five years Parts coverage on the compressor
- GEMU090 Undercounter – Two years Parts/Labor

### Gourmet Ice Makers - UCG Series

- Three years Parts and Labor

### Dispensers – CD and IOD Series

- IOD Countertop Dispensers – Two years Parts warranty and one year Labor warranty

### Storage Bins

- Two years Parts/Labor
- CD Hotel Dispensers – Three years Parts/Labor warranty

### Water Filter Manifold Systems

- One year Parts/Labor (*excluding cartridges*)

### Accessories

- One year Parts only

### Residential Installation

- All commercial machines installed in residential applications have one year Parts warranty



# The best for your business.

Some people may not realize it, but ice is a type of food. It's also a key ingredient in most foodservice applications around the world. That's why it's very important to select the right type of ice and ice machine for your business.

When choosing a machine, there are several factors that need to be considered, including ice type, machine location, sizing/ice amount and condenser style.



# Model Number Guide

## Elevation Series™ - Cube Ice

**CIM0335FA** CIM ..... Model CIM = Cube Ice Modular Series  
03 ..... Basic Family Size (kg/24 hr): 03/04/10 = 136/182/454 kg  
3 ..... Width of machine: 3 = 768 mm, 2 = 565 mm, 4 = 1226 mm  
5 ..... Unit Electrical Characteristics: 5\*\*\*  
F ..... Cube Type: H = Half, F = Full, G = Grande  
A ..... Condenser Type: A = Air, W = Water, R = Remote

## UCG Series - Gourmet Ice Makers

**UCG065A** UCG ..... Undercounter Gourmet Series  
060 ..... Basic Family Size (kg/24 hr): 06/08/10/13 = 28/37/46/59 kg  
5 ..... Unit Electrical Characteristics: 5\*\*\*  
G ..... Cube Type: G = Gourmet, GG = Gourmet Grande  
A ..... Condenser Type: A = Air Cooled

## Pearl Ice® & Flake Ice Makers

**GEM0955A** GEM ..... Model GEM = Modular Pearl Ice®, Model MFI = Modular Flake Ice Series  
095 ..... Basic Family Size (kg/24 hr): Approximately 431 kg  
5 ..... Unit Electrical Characteristics: 6 \*\*\*  
A ..... A = Air Cooled, W = Water Cooled, R = Remote Condenser

## Remote Condensers

**RCA2061-HM** RCA ..... RCA = Remote Condenser for cubers with a Headmaster  
RGA = Remote Condenser for pearl/flakers without a Headmaster  
20 ..... Coil Size  
5 ..... Unit Electrical Characteristics: 5\*\*\*  
1 ..... Number of Circuits

## Storage Bins

**B55** B ..... Model B = Bin  
55 ..... Approx. Size: 55 = 250 kg capacity

## Water Filter Systems

**IF14C** IF1 ..... Filter Type: IF1 = Ice-O-Matic Filter, INLINE TYPE  
4 ..... Fitting Size: 4 = 6.35 mm, 8 = 9.525 mm

**IFQ1** IFQ ..... Filter Type: IFQ = Ice-O-Matic Filtration System, IFQ Series  
1 ..... Number of Cartridges: 1 = Single, 2 = Double

\*\*\* Unit Electrical Characteristics  
5 - 220-240/50/1





# Ice Forms & Series Guide

## GOURMET SERIES™ Cube Ice Series – Undercounters



**Gourmet (G)**  
(H) 31.75 mm  
(Dia.) 21.5 mm



**Gourmet Grande (GG)**  
(H) 38 mm  
(Dia.) 41.5 mm

## PEARL Ice® Makers



**Pearl (P)**  
(H) 12.7 mm  
(Dia) 9.5 mm

## FLAKE Ice Makers

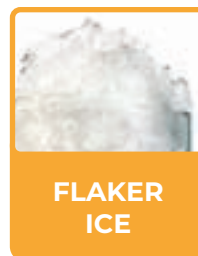

**Flake (F)**

## ELEVATION SERIES™ Cube Ice Makers - Modular



**Half (H)**  
(H) 10 mm  
(W) 22 mm  
(D) 22 mm



**Full (F)**  
(H) 23 mm  
(W) 22 mm  
(D) 22 mm



**Grande (GR)**  
(H) 31 mm  
(W) 29 mm  
(D) 22 mm

## ICE SERIES™ Cube Ice Makers & Undercounters



**Half (H)**  
(H) 10 mm  
(W) 22 mm  
(D) 22 mm



**Full (F)**  
(H) 22 mm  
(W) 22 mm  
(D) 22 mm

# We make it easy.

**Buying an ice machine doesn't have to be a challenge.**

Determining production requirements and the type of ice you need is a good first step and will help make the process a little easier.



ice  
is  
food.



## UCG Series™ - Undercounters

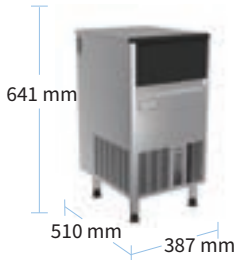

Model Number	Ice Production 10°C Water 10°C Air	Ice Production 21°C Water 10°C Air	Ice Production 32°C Water 21°C Air	Bin Storage (kg)	Condensing Unit	Voltage Units	Ship Weight (kg)
UCG045A	25	20.5	18	8	Air	230/50/1	37
UCG065A	28	27	21.5	8	Air	230/50/1	37

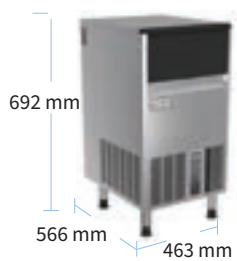

Model Number	Ice Production 10°C Water 10°C Air	Ice Production 21°C Water 10°C Air	Ice Production 32°C Water 21°C Air	Bin Storage (kg)	Condensing Unit	Voltage Units	Ship Weight (kg)
UCG085A	40	38.5	31	15	Air	230/50/1	41

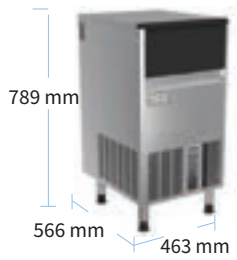

Model Number	Ice Production 10°C Water 10°C Air	Ice Production 21°C Water 10°C Air	Ice Production 32°C Water 21°C Air	Bin Storage (kg)	Condensing Unit	Voltage Units	Ship Weight (kg)
UCG105A	48	47.5	38	22	Air	230/50/1	44
UCG135A	57	58	47	22	Air	230/50/1	45

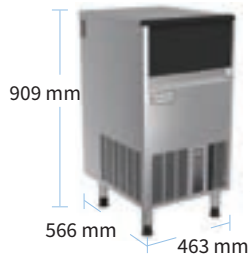

Model Number	Ice Production 10°C Water 10°C Air	Ice Production 21°C Water 10°C Air	Ice Production 32°C Water 21°C Air	Bin Storage (kg)	Condensing Unit	Voltage Units	Ship Weight (kg)
UCG165A	73	69	63	40	Air	230/50/1	52

## UCG Series™ - Accessories

Model Number	Description	Ship Weight (kg)
1011411-87	True Undercounter Leg for UCG105A, UCG135A and UCG165A	1.8



# The choice is clear.

Our self-contained gourmet cube ice makers are designed with many practical features that make them reliable and carefree to operate. With durable stainless steel top panels and convenient slide-away doors, the self-contained models are perfect for bars, wait stations and undercounter applications.

ice  
is  
food.



## ICE Series™ - Undercounters



Model Number	Ice Production 21°C Water 32°C Air	Ice Production 10°C Water 21°C Air	Half or Full Cube	Condensing Unit	Voltage Units	Ship Weight (kg)
ICEU225A	96	65	H/F	Air	220-240/50/1	73
ICEU225A	95	79	H/F	Water	220-240/50/1	73



Model Number	Ice Production 21°C Water 32°C Air	Ice Production 10°C Water 21°C Air	Half or Full Cube	Condensing Unit	Voltage Units	Ship Weight (kg)
ICEU305A	136	101	H/F	Air	220-240/50/1	93
ICEU305W	143	121	H/F	Water	220-240/50/1	92



# The industry standard.

It's that familiar clinking sound in your favorite beverage. It's the fresh, crystal-clear ice that tumbles into glasses at restaurants, bars and convenience stores around the world, cooling the drink while preserving the flavor. Our widely popular cube ice never goes out of style and is perfect for any application or occasion. Long-lasting cube ice is the right choice for a wide variety of uses.

ice  
is  
food.



### **SEALED FOOD ZONE**

Unparalleled food safety. The only ice maker in the industry with a sealed food zone.

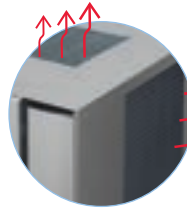

### **DUAL EXHAUST**

Groundbreaking technology allows hot-air discharge from the side or the top of every unit for the ultimate in flexibility.



### **SNAP IN AND OUT PLASTIC PARTS**

Sanitation has never been easier. Parts snap in and out and are dishwasher safe, no bottle brushes or tools required.

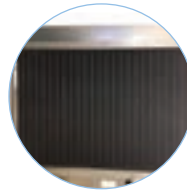

### **STANDARD AIR FILTER**

Cleaning made easy, removable and washable filter comes standard on Elevation Series machines.



### **ONE-TOUCH CLEANING**

One touch to sanitize, one touch to de-lime. LEDs signal when cleaning is required.

# The Elevation Series.

## SIMPLY THE CLEANEST ICE MACHINES

Our new and ground breaking Elevation Series is designed to simplify life. Our cube ice machines are easy to clean, easy to service, simple to operate, and environmentally responsible without sacrificing productivity. The Elevation Series provides clean, dependable ice from an astonishingly user-friendly and energy-efficient machine designed to work as hard as you. We believe design simplicity equals operational excellence, and innovation goes beyond just adding bells and whistles.

ice  
is  
food.





# Elevation Series™

## Modular Ice Makers

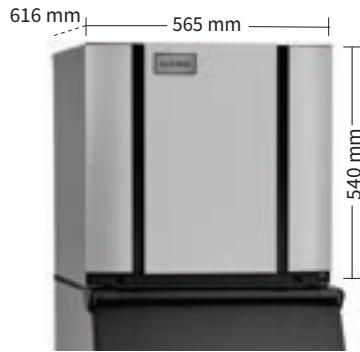

Model Number	Ice Production 21°C Water 0°C Air	Ice Production 21°C Water 32°C Air	Half or Full Cube	Condensing Unit	Voltage Units	Ship Weight (kg)
CIM0325A	132	100	H/F	Air	220-240/50/1	330
CIM0525A	240	194		Air	220-240/50/1	363

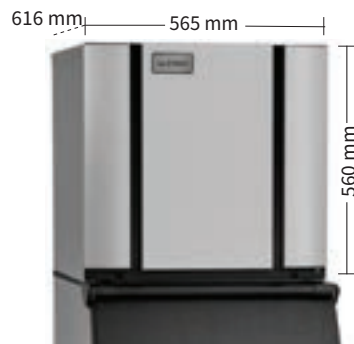

Model Number	Ice Production 21°C Water 0°C Air	Ice Production 21°C Water 32°C Air	Half or Full Cube	Condensing Unit	Voltage Units	Ship Weight (kg)
CIM0825A	418	329	H/F	Air	220-240/50/1	506
CIM0825R*	414	369		Remote		484
CIM1125A	425	374		Air		506
CIM1125R*	489	420		Remote		473



Model Number	Ice Production 21°C Water 0°C Air	Ice Production 21°C Water 32°C Air	Half or Full Cube	Condensing Unit	Voltage Units	Ship Weight (kg)
CIM0335A	132	100	H/F	Air	220-240/50/1	319
CIM0435A	209	161		Air	220-240/50/1	341
CIM0535A	240	193		Air	220-240/50/1	341
CIM0535W	241	216		Water	220-240/50/1	341
CIM0535R*	222	193		Remote	220-240/50/1	352
CIM0635A	265	204		Remote	220-240/50/1	352

Qualifies for Energy Star

\* See Page 22 for RCA/RGA Series Remote Condensers.





# Elevation Series™

Modular Ice Makers



Model Number	Ice Production 21°C Water 0°C Air	Ice Production 21°C Water 32°C Air	Half/Full/ Grande Cube	Condensing Unit	Voltage Units	Ship Weight (kg)
CIM0835A	418	329	H/F	Air	220-240/50/1	484
CIM0835R*	413	389	H/F	Air	220-240/50/1	484
CIM0835GA**	383	322	GR	Air	220-240/50/1	506
CIM1135A	425	374	H/F	Water	220-240/50/1	484
CIM1135W	467	420	H/F	Remote	220-240/50/1	495
CIM1135R*	470	420	H/F	Remote	220-240/50/1	517

\* See Page 24 for RCA/RGA Series Remote Condensers.

\*\* Grande Cube

All CIM Air Condensing models may be specific for a Top Air Discharge Only. Top Air Only units ship from factory with solid, non-louvered side panels, allowing for unique design solutions. Add a "T" to the end of any CIM Air Condensing unit to specify top air in your order. For Example: CIM330HAT



Model Number	Description	Ship Weight (kg)
BPF-1	Filler Panel Kit with 768 mm CIM and ICE Series™ Cube Ice Makers for <b>B110 bins only</b>	4
KBT5	Bin Top for 768 mm CIM and ICE Series Cube Ice Makers including the ICE1506 family for <b>B100 bin</b>	14
KBT23	Bin Top for (1) 565 mm CIM Series Ice Makers on a <b>B110 bin</b>	10
KBT222	Bin Top for (2) 565 mm CIM Series Ice Makers on a <b>B110 bin</b>	15
KCFS9-22*	Mounting kit for Coca-Cola Freestyle 9000 with 565 mm CIM Series Ice Cube Makers	2.5
KCFS91-22*	Mounting kit for Coca-Cola™ Freestyle 9100 with 565 mm CIM Series Ice Cube Makers	2.5
KCFS71-30	Mounting kit for Coca-Cola™ Freestyle 7000/7100 with 768 mm CIM Series Ice Cube Makers	2.5
KCFS9-30*	Mounting kit for Coca-Cola™ Freestyle 9000 with 768 mm CIM Series Ice Cube Makers	5
KCFS91-30*	Mounting kit for Coca-Cola™ Freestyle 9100 with 768 mm CIM Series Ice Cube Makers	2.5

\* Adapter from Coca-Cola™ also required.

# FoodZone Disassembly and Cleaning

Incorporate FoodZone disassembly into your daily cleaning procedure for maximum machine uptime and food cleanliness



Loosen the two screws on the bottom of the front panel.



Remove the top plastic cover.



Remove the water hose.



Remove the evaporator splash plate.



Remove the distribution tube, depressing both side tabs.



Completely disassemble the distribution tube.



Swing up and depress the curtain's tabs to remove.



Remove the water reservoir by sliding out, down, and out.



All food zone parts are high temp dishwasher safe.





design tip  
twins on  
a bin

Run both air-cooled heads during busy season and one during slow seasons. The possibilities are endless!

# Simplicity Elevated.

As the most advanced ice maker on the market, the new Elevation Series machines are easy to clean, easy to operate, easy to service and environmentally responsible without sacrificing productivity. Only from Ice-O-Matic, the leader in ice, pure and simple.

ice  
is  
food.



# Flake Ice® Series

Modular  
Makers/Dispensers  
Accessories

## Flake Ice® Series™ Modular Ice Makers

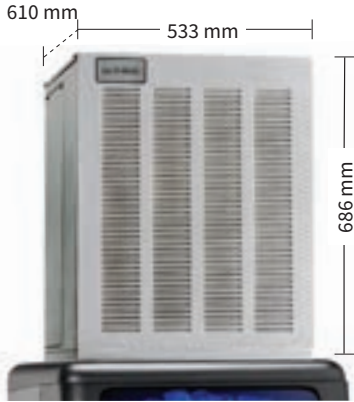

Model Number	Ice Production		Flaker Ice	Condensing Unit	Voltage Units	Ship Weight (kg)
	21°C Water 32°C Air	10°C Water 21°C Air				
MF10805A	245	333	F	Air	220-240/50/1	93
MF10805W	274	334	F	Water	220-240/50/1	91
MF11255A	408	572	F	Air	220-240/50/1	98
MF112255W	454	558	F	Water	220-240/50/1	104

Qualifies for Energy Star

\* See Page 22 for RCA/RGA Series Remote Condensers.

## Flake Ice® Series™ Accessories

Model Number	Description	Ship Weight (kg)
BPF-1	Filler Panel Kit with 768 mm GEM Series Ice® Makers for <b>B110 bins only</b>	4
KBT5	Bin Top for 768 mm GEM Series Ice® Makers on a B100 bin	14
KBT19	Bin Top for 534 mm GEM Series Ice® Makers on a 768 mm bin	10
KBT222	Bin Top for (2) GEM Series Ice® Makers on a B110 bin	15
KBT23	Bin Top for (1) GEM Series Ice® Makers on a B110 bin	15
KBT24	Bin Top for (1) GEM Series Ice® Makers on a 565 mm bin	5
KGEMDISP	Kit required when mounting GEM Series Ice® Makers to beverage dispenser (Cornelius and Lancer)	.5
KGEMFS	Mounting and bin level ice control kit, required for installation of 534 mm GEM Series Ice® Makers on Coca-Cola™ Freestyle dispenser model 9000. Requires Coke Adapter to match Freestyle dispenser color.	3
KFS7-G	Ice Control Kit, required for installation of 534 mm GEM Series Ice® Makers on a Coca-Cola™ Freestyle dispensers model 7000.	3
KBTF230	Bin Kit for (2) 30" GEM Series Ice® Makers on 1524 mm bins only	.5



# Pearl Ice® Series

Modular  
Makers/Dispensers  
Accessories

## Pearl Ice® Series™ –Ice/Water Dispenser

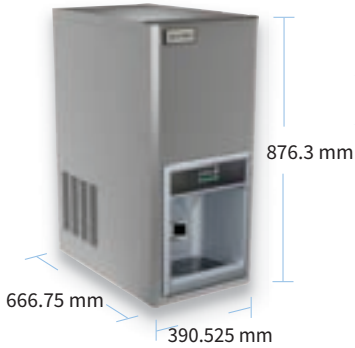

Model Number	Ice Production		Pearl Ice	Bin Storage (kg)	Condensing Unit	Voltage Units	Ship Weight (kg)
	21°C Water 32°C Air	10°C Water 21°C Air					
GEMD275AZ	86	114	P	5.5	Air	230/50/1	73

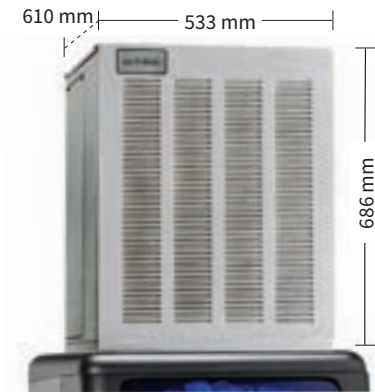

Model Number	Ice Production (kg/24 hr)		Condensing Unit	Voltage Units	Ship Weight (kg)
	21°C Water 32°C Air	10°C Water 21°C Air			
GEM0655A	224	302	Air	220-240/50/1	93
GEM0655W	262	317	Water	220-240/50/1	91
GEM0955A	349	478	Air	220-240/50/1	110
GEM0955W	420	512	Water	220-240/50/1	100



# Perfect for presentation.

Our flake ice is ideal for both the presentation and preservation of perishable food items. Ice-O-Matic flake ice extends the shelf life and appearance of seafood, fresh fruits and vegetables for fresher displays that help increase sales. Flake ice is also ideal for use in bakeries, perishable food transport and health care applications.

ice  
is  
food.



## Remote Condensers

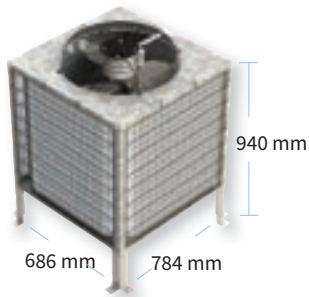

Model Number	Description	Voltage Units	Ship Weight (kg)
RCA1061	Remote Condenser for model CIM0535R	208-230/50/1	44

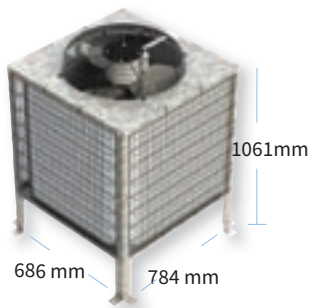

Model Number	Description	Voltage Units	Ship Weight (kg)
RCA2061	Remote Condenser for models CIM0825R, CIM0835R, CIM1135R	208-230/50/1	50
RCA3061	Remote Condenser for model CIM1545R, CIM1845R		50

## Remote Condenser Accessories

Model Number	Description	Ship Weight (kg)
RT325404	8 meters Precharged Tubing Kit for units using R-404A refrigerant	6
RT340404	12.5 meters Precharged Tubing Kit for units using R-404A refrigerant	9
RT375404	23 meters Precharged Tubing Kit for units using R-404A refrigerant	17
GRILL10	Optional Grill Guard Kit for RCA-1001, RCA-1061, RGA-0501-HM and RGA-1061-HM	4
GRILL20	Optional Grill Guard Kit for RCA-2061 and RCA-3561	6





# Discover the difference.

The Ice-O-Matic difference means customers receive American made purity, simplicity, productivity and reliability. Every time.



ice  
is  
food.



# Dispensers

Countertop Dispensers  
Hotel Dispensers

## Hotel Cube Ice Dispensers



Model Number	Dispenser Operation	Bin Storage (kg)	Voltage Units	Ship Weight (kg)
CD40522*	Push Activated	55	220-240/50/1	104



Model Number	Dispenser Operation	Bin Storage (kg)	Voltage Units	Ship Weight (kg)
CD40530**	Push Activated	81	220-240/50/1	100

\* Accepts only 565 mm Machines  
\*\* Accepts only 768 mm Machines



## Ice Dispenser & Hotel Accessories

Model Number	Description	Ship Weight (kg)
KWGFID	Water glass filler kit for CD40522 (field installed only)	1
KGEMDISP	Kit required when mounting GEM to beverage dispenser (Cornelius and Lancer)	.5
KCUBEDISP*	Bin-level kit for Cornelius and Lancer dispensers with 768 mm CIM Series Cube Ice Makers (Bin stat and deflector included)	.5
KFS7-22*	Mounting kit for Coca-Cola™ Freestyle 7000 & 7100 with 565 mm ICE Series Cube Ice Makers	4
KFS7-30*	Mounting kit for Coca-Cola™ Freestyle 7000 & 7100 with 768 mm ICE Series Cube Ice Makers	5
KCFS71-30*	Mounting kit for Coca-Cola™ Freestyle 7000 & 7100 with 768 mm CIM Series Cube Ice Makers	4
KFS9-22**	Mounting kit for Coca-Cola™ Freestyle 7000 & 7100 with 565 mm ICE Series Cube Ice Makers	3
KCFS91-22**	Mounting kit for Coca-Cola™ Freestyle 7000 & 7100 with 565 mm ICE Series Cube Ice Makers	3
KCFS91-30**	Mounting kit for Coca-Cola™ Freestyle 7000 & 7100 with 768 mm CIM Series Cube Ice Makers	7
KCFS9-30**	Mounting kit for Coca-Cola™ Freestyle 7000 & 7100 with 768 mm CIM Series Cube Ice Makers	5
KGEMFS*	Mounting and bin level ice control kit, required for installation of 565 mm Pearl Ice Makers on Coca-Cola™ Freestyle dispenser model 9000. Requires Coca-Cola™ Adapter to match Freestyle dispenser (Red, Silver or Black)	5

\* Adapter from Coca-Cola™ also required.

## Dispenser Kits

Model Number	Style	CIM Series Cube Ice Makers	
		565 mm W	768 mm W
GENERIC DISPENSER	Lancer/Serv-end Etc.	KCUBEDISP	KCUBEDISP
CD40522	565 mm Hotel Dispenser	▲	N/A
CD40530	768 mm Hotel Dispenser	N/A	▲
FS7000	768 mm Countertop Coke Dispenser	KCUBEDISP	KFS71-30
FS7100	768 mm Countertop Coke Dispenser	KCUBEDISP	KFS71-30
FS9000	565 mm Freestanding Coke Dispenser	KCFS9-22	KCFS9-30
FS9100	565 mm Freestanding Coke Dispenser	KCFS91-22	KCFS91-30
PEPSI SPIRE	768 mm Countertop Pepsi Dispenser	KCUBEDISP	KCUBEDISP

This information is subject to change. Please visit our website [www.iceomatic.com](http://www.iceomatic.com) for the most recently updated kit information.

▲ Kit not required

N/A - Ice Machine and Dispenser not applicable



# Storage Bins

Bins  
Adapters  
Accessories

## Storage Bins



Model Number	Bin Storage (kg)	Dimensions W x D x H (mm)	Ship Weight (kg)
B25	110	768 x 787 711	34
B40	156	768 x 787 x 953	47
B42	160	559 x 787 x 1270	45
B55	232	768 x 787 x 1270	57
B110	388	1219 x 787 1270	87



Model Number	Bin Storage (kg)	Dimensions W x D x H (mm)	Ship Weight (kg)
B700-30	308	768 x 787 x 1524	96
B1000-48	454	1219 x 787 x 1651	123
B1300-48	599	1219 x 787 x 1424	146
B1325-60	601	1524 x 787 x 1424	146
B1600-60	753	1524 x 787 x 1651	154

## Bin Top Adapters

Model Number	Description	Ship Weight (kg)
KBT5	Bin Top for 768 mm CIM and ICE Series Cuber including the ICE1506 family <b>for B100 only</b>	14
KBT19	Bin Kit for 565 mm CIM, MFI and GEM Series on a 762 mm bin	10
KBT222	Bin top for (2) 565 mm CIM, (2) MFI or (2) GEM Series on B110 bin	15
KBT23	Bin Kit for (1) 565 mm CIM, (1) GEM or (1) MFI Series on a B110 bin	15
KBT24	Bin Kit for (1) GEM or (1) MFI on a 559 mm bin	5
KBTF230	Bin Kit for (2) 768 mm CIM, GEM and MFI Series Cube Ice Makers <b>on 60" bins only</b>	20
BPF-1	Filler Panel Kit with 768 mm CIM, GEM, MFI and ICE Series™ Cube Ice Makers <b>for B110 bins only</b>	4

## Bin Accessories

Model Number	Description	Ship Weight (kg)
KLSCO	2.5 liter ice scoop*	1
KSSCO	.5 liter ice scoop*	1
KSHOV	Plastic shovel	2
KSHOB	Bracket shovel	1
KICEP	Plastic paddle	4
KPBRA	Bracket paddle	1

\* Ice scoop sold separately for B700-30, B1000-48, B1300-48, B1325-60 and B1600-60 models.



## Single Ice Machine Configurations

Model Number	Style	CIM Series Cube Ice Makers			Flake Ice Makers	
		559 mm wide	768 mm wide	1226 mm wide	534mm wide	768 mm wide
B25PP**	Slope Front	KBT19	▲	N/A	KBT19	▲
B40PS	Slope Front	KBT19	▲	N/A	KBT19	▲
B42PS	Slope Front	▲	N/A	N/A	KBT19	N/A
B55PS	Slope Front	KBT19	▲	N/A	KBT19	▲
B110PS	Slope Front	KBT23	BPF-1***	▲	KBT23	BPF-1***
B700-30	Upright	▲	▲	▲	▲	▲
B1000-48	Upright	▲	▲	▲	▲	▲
B1300-48	Upright	▲	▲	▲	▲	▲
B1325-60	Upright	▲	▲	▲	▲	▲
B1600-60	Upright	▲	▲	▲	▲	▲

\*\* Rotocast finish / \*\*\* BPF-1 used with B110 bins only. If you have an older model B100 use the KBT5.  
 ▲ Kit not required / N/A - Ice Machine and Bin Configurator not applicable

## Side-By-Side Ice Machine Configurations

Model Number	Style	CIM Series Cube Ice Makers		Flake Ice Makers	
		559 mm (x2) wide	768 mm (x2) wide	534 mm (x2) wide	768 mm (x2) wide
B25PP**	Slope Front	N/A	N/A	N/A	N/A
B40PS	Slope Front	N/A	N/A	N/A	N/A
B42PS	Slope Front	N/A	N/A	N/A	N/A
B55PS	Slope Front	N/A	N/A	N/A	N/A
B110PS	Slope Front	KBT222	N/A	KBT222	N/A
B700-30	Upright	N/A	N/A	N/A	N/A
B1000-48	Upright	▲▲	N/A	▲▲	N/A
B1300-48	Upright	▲▲	N/A	▲▲	N/A
B1325-60	Upright	▲▲	KBT230*	▲▲	KBT230*
B1600-60	Upright	▲▲	KBT230*	▲▲	KBT230*

\* Must use remote or water cooled model only / \*\* Rotocast finish  
 ▲ Kit not required  
 N/A - Ice Machine and Bin Configurator not applicable

There are times when it is desirable to install (2) ice machines side-by-side on a bin. The reasons may range from gaining maximum output to creating redundancy. Ice-O-Matic offers an array of kits and bins with custom order tops for just such applications.



## Water Filtration Systems



### IFQ1-S

Single Filter

dimensions (mm)	265 x 153 x 102
flow rate max (gpm)	.75
pressure max (psi)	125
max operating temp (°C)	38
micron rating	0.5
ship weight (kg)	1
pack quantity	N/A



### IFQ1

Single Filter

dimensions (mm)	381 x 153 x 102
flow rate max (gpm)	.75
pressure max (psi)	125
max operating temp (°C)	38
micron rating	0.5
ship weight (kg)	2
pack quantity	N/A



### IFQ1-XL

Single Filter

dimensions (mm)	534 x 153 x 102
flow rate max (gpm)	.75
pressure max (psi)	125
max operating temp (°C)	38
micron rating	0.5
ship weight (kg)	3
pack quantity	N/A



### IFQ2

Dual Filter

dimensions (mm)	407 x 254 x 181
flow rate max (gpm)	.75
pressure max (psi)	125
max operating temp (°C)	38
micron rating	0.5
ship weight (kg)	4
pack quantity	N/A



### IFQ2-XL

Dual Filter

dimensions (mm)	590 x 331 x 119
flow rate max (gpm)	.75
pressure max (psi)	125
max operating temp (°C)	38
micron rating	0.5
ship weight (kg)	4
pack quantity	N/A



### IF14C / IF18C

Single Inline Cartridge .25" Compression (IF14C) or .375" Compression (IF18C)

dimensions (mm)	299 x 70
flow rate max (gpm)	.75
pressure max (psi)	125
max operating temp (°C)	38
micron rating	0.5
ship weight (kg)	1
pack quantity	N/A



## IOM Replacement Cartridges

Model Number	Description	Pack Qty
IOMQ-S	Single quick twist replacement cartridge for IFQ1-S	N/A
IOMQ	Single quick twist replacement cartridge for IFQ1 or IFQ2	10
IOMQ-XL	Single quick twist replacement cartridge for IFQ1-XL	N/A
IOMWFRC	Single replacement filter with male quick connect fittings for manifold filter systems	10

## Filter Cartridge Features

- Inhibit the formation of scale
- Remove dirt and sediment
- Reduce chlorine, taste and odor

*Ice-O-Matic recommends the use of water filtration with all ice-making products.*

## Water Filtration Application Charts - CUBE

Model Number	ICEU250 ICEU350	CIM0350	CIM0525	CIM0825- CIM1135	UCG085- UCG135
IFQ1-S	X				X
IFQ1		X			
IFQ1-XL			X		
IFQ2				X	
IFQ2-XL					
IFI4C / IF18C	X				X

## Water Filtration Application Charts - PEARL & FLAKE

Model Number	MFI805-MFI1255
IFQ1-S	
IFQ1	
IFQ1-XL	X
IFQ2	
IFQ2-XL	
IFI4C / IF18C	

# Pricing Details.

View our most current pricing structures. Ice-O-Matic's knowledgeable sales representatives can also answer any questions and walk you through the selection process.



## Contact Us.

### Sales and Customer Service

Whether you have a sales question, a support inquiry, or just need to hear a friendly voice our outstanding customer service is available for you.

**Call Us: 1-800-423-3367**

**Online: [iceomatic.com/servicesupport](https://iceomatic.com/servicesupport)**

**Email: [customerservice@iceomatic.com](mailto:customerservice@iceomatic.com)**

### Technical Support 24/7 Support

Our technical support center provides best-in-class service with decades of experience. Contact day or night with your most technical questions!

**Call Us: 303-371-3737**

**Online: [iceomatic.com/servicesupport](https://iceomatic.com/servicesupport)**

**Email: [techsupport@iceomatic.com](mailto:techsupport@iceomatic.com)**

©2022 Ice-O-Matic. ® a Registered Trademark of Ice-O-Matic.

We reserve the right to make changes in design, specifications, and content at any time without obligation. AgION® antimicrobial is registered with EPA and is a trademark of AgION Technologies.

an Ali Group Company



The Spirit of Excellence





ice  
is  
food.

**Ice-O-Matic**   
Ice. Pure and Simple<sup>®</sup>

11100 East 45th Avenue | Denver, CO 80239  
866.PUREICE | [iceomatic.com](http://iceomatic.com)